

Equipment
Pool & SPA





Η Εταιρεία

Η εταιρεία **OXYGON** κατέχει ανταγωνιστική θέση στην αγορά, χάρη στη διαρκή της ανάπτυξη, την παραγωγή και διάθεση ποιοτικών προϊόντων και τον εμπλουτισμό των υπηρεσιών της, επιτυγχάνοντας έτσι τον βασικό της σκοπό που δεν είναι άλλος από τη σωστή και άμεση **εξυπηρέτηση του πελάτη**.

Το ανθρώπινο δυναμικό της, απαρτίζεται από πολιτικούς μηχανικούς, μηχανολόγους και τεχνικούς με υψηλά αισθητικά κριτήρια και άριστες τεχνικές γνώσεις, με σπουδές και επαγγελματική εμπειρία στην Ελλάδα και στο εξωτερικό. Υποστηρίζει ακόμα και τις πιο ιδιαίτερες εφαρμογές με την τεχνογνωσία που κατέχει αλλά και με την διαρκώς ενημερωμένη γκάμα προϊόντων.

Η **OXYGON** μέσω της συνεχούς ανάπτυξης του **Δικτύου Επίσημων Συνεργατών** αλλά και την εξαγωγική της δραστηριότητα σε **16 χώρες σε Ευρώπη, Ασία, Αφρική και βόρεια Αμερική**, έχει διαμορφώσει τα προϊόντα της ώστε να προσαρμόζονται σε όλες τις απαιτήσεις της εκάστοτε τοπικής αγοράς. Επίσης, καθώς πολλά από τα προϊόντα είναι δικής της παραγωγής, έχει την δυνατότητα ανάπτυξης τους με βάση τις προδιαγραφές των επαγγελματιών του κλάδου.

The Company

OXYGON holds a competitive position in the market, thanks to its continuous development, the production and distribution of quality products and the enrichment of its services, thus achieving its main purpose, which is none other than correct and immediate **customer service**.

Its human resources are made up of civil engineers, mechanical engineers and technicians with high aesthetic criteria and excellent technical knowledge, with studies and professional experience in Greece and abroad. It supports even the most special applications with the know-how it possesses and with the constantly updated range of products.

OXYGON, through the continuous development of the **Network of Official Partners** as well as its export activity in **16 countries in Europe, Asia, Africa and North America**, has shaped its products to adapt to all the requirements of each local market. Also, as many of the products are of its own production, it has the possibility of developing them based on the specifications of the industry professionals.



Always by your side



STERGIOS KARAVASILIS
ΣΤΕΡΓΙΟΣ ΚΑΡΑΒΑΣΙΛΗΣ
CEO / Owner
karavasilis@oxygen.gr



YANNIS KOKKINOS
ΓΙΑΝΝΗΣ ΚΟΚΚΙΝΟΣ
Managing Director
kokkinos@oxygen.gr



MARIA ANAGNOSTOU
ΜΑΡΙΑ ΑΝΑΓΝΩΣΤΟΥ
Administration Manager
maria@oxygen.gr



PANAGIOTIS RIGOS
ΠΑΝΑΓΙΩΤΗΣ ΡΗΓΟΣ
Store Manager
prigos@oxygen.gr



ELENI ARSAKIAN
ΕΛΕΝΗ ΑΡΣΑΚΙΑΝ
Domestic Sales
eleni@oxygen.gr

Table of Contents

| | |
|--|-----------|
| 1. Pumps - Αντλίες..... | 07 - 16 |
| 2. Filters - Φίλτρα..... | 17 - 24 |
| 3. Lights - Φωτισμός..... | 25 - 30 |
| 4. White Parts - Λευκά Εξαρτήματα..... | 31 - 40 |
| 5. INOX Equipment - Εξοπλισμός INOX..... | 41 - 44 |
| 6. Steel Panels - Μεταλλικά πάνελ για πισίνες..... | 45 - 62 |
| 7. Disinfection Systems - Συστήματα απολύμανσης..... | 63 - 74 |
| 8. Pool Finishing - Επένδυση Πισίνας..... | 75 - 108 |
| 9. Robots / Maintenance - Ρομπότ / Συντήρηση..... | 109 - 122 |
| 10. Heating/Cooling/Covers - Θέρμανση/Ψύξη/Καλύμματα..... | 123 - 156 |
| 11. Sports Equipment - Αθλητικός Εξοπλισμός..... | 157 - 160 |
| 12. Pool Decoration - Διακόσμηση Πισίνας..... | 161 - 166 |
| 13. Spa/Sauna/Steam/FiberGlass pools - Σπα/Σάουνα/Χαμαμ..... | 167 - 194 |
| 14. PVC Parts - Εξαρτήματα PVC..... | 195- 201 |

OXYGON⁺

Around the world



Oxygen, through its "Authorised Dealer" program is exporting products, materials and expertise around the world. The unique products and services of our company have the ability to adapt at the special needs of every market in cooperation with our local distributor.

For more information contact: kokkinos@oxygen.gr

Η Oxygen, μέσω του προγράμματος «Εξουσιοδοτημένος Έμπορος» εξάγει προϊόντα, υλικά και τεχνογνωσία σε όλο τον κόσμο. Τα μοναδικά προϊόντα και υπηρεσίες της εταιρείας μας έχουν τη δυνατότητα προσαρμογής στις ειδικές ανάγκες κάθε αγοράς σε συνεργασία με τον τοπικό μας διανομέα.

Για περισσότερες πληροφορίες επικοινωνήστε με: kokkinos@oxygen.gr





OXYGON⁺

Pumps - Αντλίες

mini



- High-performance swimming pool pump with integrated pre-filter, designed to deliver exceptional filtration capacity and efficient water circulation.
- Transparent polycarbonate lid for quick and easy visual inspection of the pre-filter basket, ensuring effortless maintenance.

Διαστάσεις / Dimensions

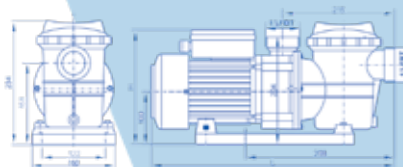

Καμπύλες επιδόσεων / Performance curves

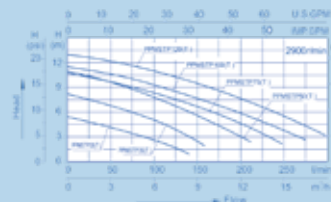

| CODE | POWER | | Q max | H max | PRICE |
|------------|-------|------|---------|-------|---------|
| | hP | kW | | | |
| 106.07.160 | 0,50 | 0,37 | 13 m³/h | 10 m | 460,82€ |
| 106.07.161 | 0,75 | 0,55 | 15 m³/h | 11 m | 471,38€ |
| 106.07.162 | 1,00 | 0,75 | 17 m³/h | 12 m | 520,61€ |
| 106.07.163 | 1,20 | 0,90 | 20 m³/h | 13 m | 576,91€ |

WAVE



Built for dependable performance, the WAVE Series ensures efficient water circulation with strong durability and safety.

- Key Specifications:
 - Liquid temperature: 5–50°C
 - Ambient temperature: ≤40°C
 - Max working pressure: 0.3 MPa
 - IPX5 waterproof rating
 - Insulation class F
 - Integrated thermal protection
 - 220V / 50Hz, single-phase
 - Max suction height: 3 m (P ≥ 600 W)

Dimensions

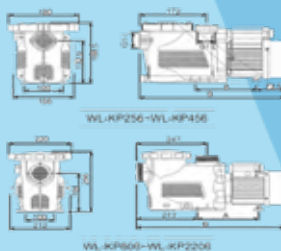

Performance Curves

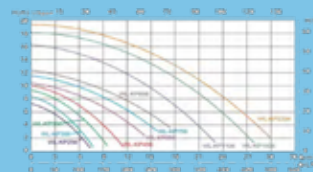

| CODE | MODEL | POWER | | Q max | H max | PRICE |
|------------|-----------|-------|------|---------|-------|---------|
| | | hP | kW | | | |
| 106.07.214 | WL-KP256 | 0,33 | 0,20 | 8 m³/h | 9 m | 485,50€ |
| 106.07.210 | WL-KP356 | 0,50 | 0,35 | 10 m³/h | 9 m | 503,04€ |
| 106.07.211 | WL-KP556 | 0,75 | 0,55 | 14 m³/h | 11 m | 513,91€ |
| 106.07.212 | WL-KP756 | 1,00 | 0,75 | 16 m³/h | 12 m | 564,60€ |
| 106.07.213 | WL-KP856 | 1,20 | 0,85 | 17 m³/h | 13 m | 622,61€ |
| 106.07.205 | WL-KP1106 | 1,50 | 1,10 | 23 m³/h | 16 m | 662,30€ |
| 106.07.206 | WL-KP1606 | 2,00 | 1,60 | 28 m³/h | 18 m | 679,34€ |
| 106.07.207 | WL-KP2206 | 3,00 | 2,20 | 30 m³/h | 19 m | 771,66€ |

Siro.



Dimensions

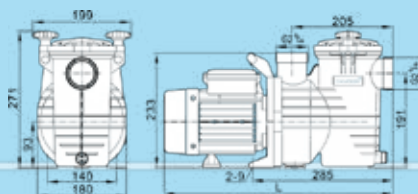

Performance Curves

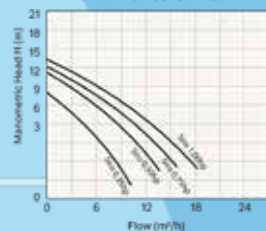

The SIRO is a high-performance, self-priming pool pump with an integrated prefilter, offering strong water circulation and excellent filtration capacity. The transparent polycarbonate lid allows quick inspection of the prefilter basket, ensuring easy maintenance and reliable operation.

Working Conditions

- Medium temperature: 5°C – 50°C
- Ambient temperature: ≤ 50°C
- Max. working pressure: 0.5 MPa

| CODE | POWER | | Q max | H max | PRICE |
|------------|-------|------|---------|-------|---------|
| | hP | kW | | | |
| 106.07.302 | 0,35 | 0,20 | 10 m³/h | 8 m | 475,50€ |
| 106.07.303 | 0,50 | 0,35 | 15 m³/h | 11 m | 495,50€ |
| 106.07.304 | 0,75 | 0,55 | 17 m³/h | 13 m | 515,50€ |
| 106.07.305 | 1,00 | 0,75 | 19 m³/h | 14 m | 555,50€ |



Dimensions

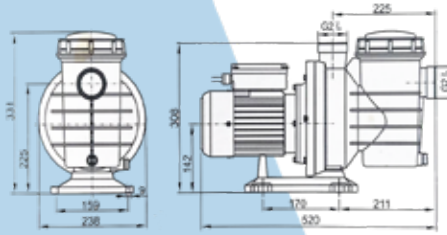

Performance Curves

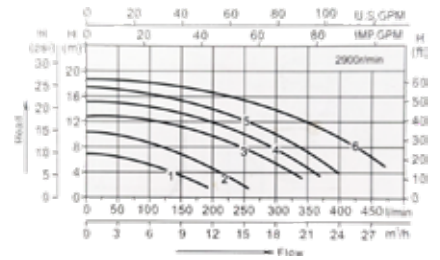

The Hera Pump bridges the gap between small spa pumps and large pool recirculation units, making it perfect for spas, medium and large pools, water treatment systems, and decorative water features.

Key Features:

- Durable build: High-strength plastics and SUS316 mechanical seal for freshwater and seawater.
- Self-priming up to 2.5 m for reliable start-up and flow.
- Low-noise motor for quiet operation.
- Long service life: High-temperature bearings for added durability.
- Safe design: Complete separation of water from the motor axis.
- Optional ON/OFF switch for added convenience.
- Certified quality: TÜV Rheinland approved.
- Insulation class F & IPX5 protection for enhanced motor safety.

| CODE | Model | Fitting | POWER hP kW | Q max | H max | PRICE |
|------------|-------|---------|-------------------|---------|-------|----------|
| 106.07.126 | Sw075 | Ø50 | 0,75 0,55 | 16 m³/h | 12 m | 560,00 € |
| 106.07.127 | Sw100 | Ø50 | 1,00 0,75 | 20 m³/h | 12 m | 580,00 € |
| 106.07.128 | Sw120 | Ø50 | 1,20 0,90 | 22 m³/h | 13 m | 595,00 € |
| 106.07.129 | Sw150 | Ø50 | 1,50 1,20 | 25 m³/h | 12 m | 655,00 € |
| 106.07.133 | Sw200 | Ø50 | 2,00 1,50 | 32 m³/h | 13 m | 715,00 € |



Dimensions

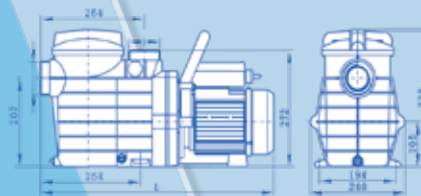

Performance Curves

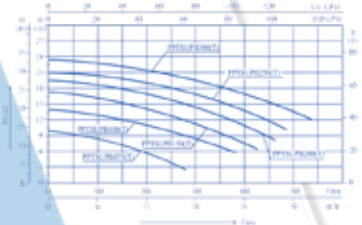

The Mira Series pump is engineered to deliver reliable performance, efficiency, and durability for modern swimming pool systems. Its robust injected-thermoplastic casing ensures long-term resistance to corrosion and demanding operating conditions, making it a dependable choice season after season. At the heart of the pump, a high-efficiency NORYL impeller reinforced with fiberglass and equipped with an AISI 316 stainless steel insert guarantees exceptional mechanical strength and smooth, optimized water circulation. This advanced design enhances hydraulic efficiency while maintaining consistent performance over time. For effortless operation and maintenance, the Mira Series features a transparent injected-plastic pre-filter basket, combined with a high-resistance transparent polycarbonate lid. This allows quick visual inspection of the basket, ensuring easy monitoring and fast cleaning without unnecessary downtime.

| 3-PHASE | | | | | |
|------------|-------------------|---------|-------|---------|--|
| CODE | POWER hP kW | Q max | H max | PRICE | |
| 106.07.179 | 1,0 0,75 | 22 m³/h | 13 m | 657,71€ | |
| 106.07.180 | 1,5 1,10 | 25 m³/h | 17 m | 758,81€ | |
| 106.07.181 | 2,0 1,50 | 28 m³/h | 19 m | 821,26€ | |
| 106.07.182 | 2,5 1,85 | 30 m³/h | 21 m | 859,25€ | |
| 106.07.183 | 3,0 2,20 | 35 m³/h | 23 m | 893,73€ | |

| 1-PHASE | | | | | |
|------------|-------------------|---------|-------|---------|--|
| CODE | POWER hP kW | Q max | H max | PRICE | |
| 106.07.169 | 1,0 0,75 | 22 m³/h | 13 m | 657,71€ | |
| 106.07.170 | 1,5 1,10 | 25 m³/h | 17 m | 758,81€ | |
| 106.07.171 | 2,0 1,50 | 28 m³/h | 19 m | 821,26€ | |
| 106.07.172 | 2,5 1,85 | 30 m³/h | 21 m | 859,25€ | |
| 106.07.173 | 3,0 2,20 | 35 m³/h | 23 m | 893,73€ | |

| SEA WATER / 3-PHASE | | | | | |
|---------------------|-------------------|---------|-------|----------|--|
| CODE | POWER hP kW | Q max | H max | PRICE | |
| 106.07.180s | 1,5 1,10 | 25 m³/h | 17 m | 1037,29€ | |
| 106.07.181s | 2,0 1,50 | 28 m³/h | 19 m | 1082,84€ | |
| 106.07.182s | 2,5 1,85 | 30 m³/h | 21 m | 1152,89€ | |
| 106.07.183s | 3,0 2,20 | 35 m³/h | 23 m | 1218,79€ | |

| SEA WATER / 1-PHASE | | | | | |
|---------------------|-------------------|---------|-------|----------|--|
| CODE | POWER hP kW | Q max | H max | PRICE | |
| 106.07.169s | 1,5 1,10 | 25 m³/h | 17 m | 924,79€ | |
| 106.07.170s | 1,5 1,10 | 25 m³/h | 17 m | 1037,29€ | |
| 106.07.171s | 2,0 1,50 | 28 m³/h | 19 m | 1082,84€ | |
| 106.07.172s | 2,5 1,85 | 30 m³/h | 21 m | 1152,89€ | |
| 106.07.173s | 3,0 2,20 | 35 m³/h | 23 m | 1218,79€ | |

Sea Water / Dual Speed

| CODE | POWER hP kW | Q max | H max | PRICE |
|----------------|--------------------------|------------|----------|----------|
| 106.07.171s-II | 3/8 - 2,0 0,35 - 1,50 | 13-28 m³/h | 4 - 19 m | 1670,16€ |
| 106.07.172s-II | 1/2 - 2,5 0,40 - 1,85 | 14-29 m³/h | 5 - 21 m | 1806,48€ |
| 106.07.173s-II | 5/8 - 3,0 0,45 - 2,20 | 15-32 m³/h | 6 - 23 m | 1898,26€ |

IRIS

variable speed



The **IRIS** series pump creatively combines the most advanced technology with professionally designed pool pump hydraulic structure to create easier to use, quieter, smarter, more efficient and less expensive variable speed pool pumps.

Low Noise

IRIS pumps reduce operating noise by featuring an upgraded motor that offers quieter high operating speeds. Sound level 45 dB at 1 meter at 1400 rpm.



Mobile App



Energy Saving

IRIS pumps reduce energy consumption by up to 90% saving up to 12.614 kWh. (2hp pump working 365 days) High performance IE4 engine. Insulation class F IP55 waterproof standard.. Maximum operating pressure 3,5 bar

Dimensions

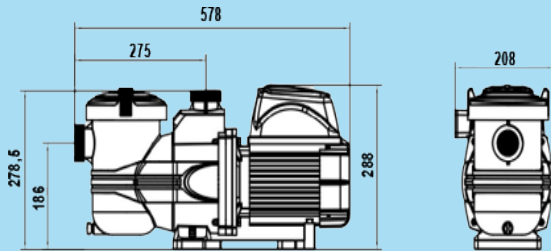

Performance Curves

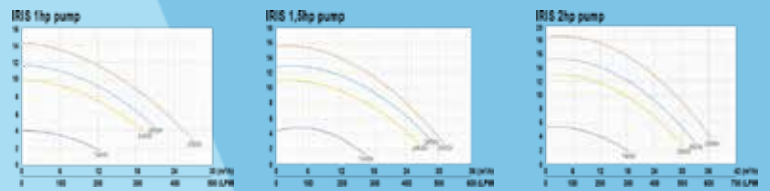

| CODE | POWER hP | POWER kW max | Q max | H max | RPM | PRICE |
|-------------|-------------|-----------------|---------|--------|-------------|----------|
| 102.01.121 | 1,0 | 0,75 | 27 m3/h | 14,5 m | 1000 - 2900 | 1850,00€ |
| 102.01.122 | 1,5 | 1,10 | 30 m3/h | 16,0 m | 1000 - 2900 | 1975,00€ |
| 102.01.123i | 2,0 | 1,50 | 33 m3/h | 17,0 m | 1000 - 2900 | 2150,00€ |

Alpha



Alpha series high performance PP centrifugal pump delivers high flow rates. It's designed for the commercial swimming pools, spa, waterfalls and water features to achieve the maximum working efficiency with the lowest noise. Suitable for operation with salt chlorinators and sea water.

Highlight Features:

- High efficiency motor IE3
- IPX5 waterproof standard
- Asynchronous, two poles
- Insulation class: F
- The advanced diffuser and high efficiency turbine maximize water flow and energy efficiency while minimizing turbulence and noise.
- Self-priming up to 3m above water level
- Built-in thermal protection and overload protection
- The oversized pre-filter basket (5L) extends the interval between cleanings

The advanced diffuser and high efficiency turbine maximize water flow and energy efficiency while minimizing turbulence and noise.



Dimensions

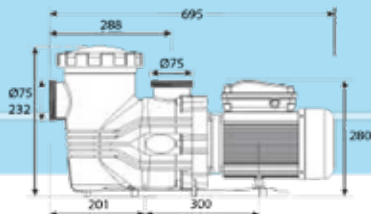

High Performance

IE3 motor

Self-Priming up to 3m

Performance Curves

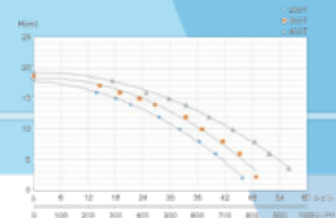

3-PHASE

| CODE | hP | POWER kW | Q max | H max | PRICE |
|------------|-----|-------------|---------|--------|----------|
| 102.01.118 | 2,0 | 1,50 | 43 m3/h | 18,5 m | 1440,38€ |
| 102.01.119 | 3,0 | 2,20 | 48 m3/h | 19,0 m | 1530,37€ |
| 102.01.120 | 4,0 | 2,70 | 55 m3/h | 19,5 m | 1620,91€ |

1-PHASE

| CODE | hP | POWER kW | Q max | H max | PRICE |
|------------|-----|-------------|---------|--------|----------|
| 102.01.116 | 2,0 | 1,50 | 42 m3/h | 18,0 m | 1446,12€ |
| 102.01.117 | 3,0 | 2,20 | 45 m3/h | 18,5 m | 1605,82€ |

Syren



Dimensions

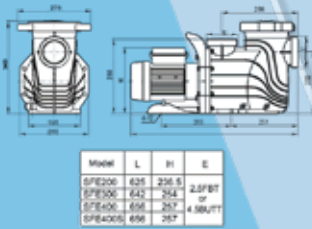

Performance Curves

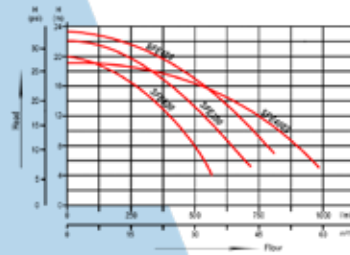

| CODE | POWER | | Q max | H max | PRICE |
|-------------|-------|-----|---------|-------|----------|
| | hP | kW | | | |
| 102.01.136 | 2,0 | 1,5 | 35 m3/h | 20 m | 1224,33€ |
| 102.01.137 | 3,0 | 2,2 | 44 m3/h | 22 m | 1300,83€ |
| 102.01.138 | 4,0 | 3,0 | 49 m3/h | 23 m | 1377,78€ |
| 102.01.138S | 4,0 | 3,0 | 59 m3/h | 18 m | 1657,75€ |

CALYPSO



Performance Curves

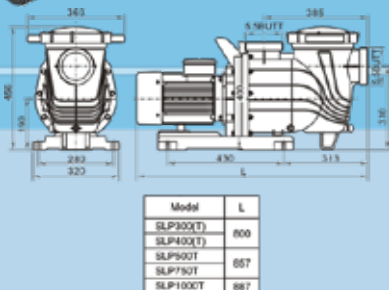

Dimensions

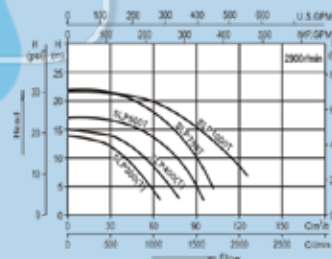

The Calypso C-Series is a high-energy-efficiency pool pump designed for demanding circulation and filtration applications. Supplied as standard with an integrated plastic support base, it ensures stable installation and long-term reliability.

Equipped with a high-efficiency motor, the Calypso C-Series delivers significant energy savings while providing a long service life and consistent performance. The pump is engineered to operate safely for extended periods in environments with temperatures of up to 75°C, making it suitable for hot spring and thermal water circulation.

Thanks to its robust construction and dependable operation, the Calypso C-Series is ideal for large swimming pools, water parks, aquariums, and other large-scale water filtration and circulation systems.

| CODE | POWER | | Q max | H max | PRICE |
|------------|-------|-----|----------|--------|----------|
| | hP | kW | | | |
| 102.01.131 | 3,0 | 2,2 | 65 m3/h | 14,0 m | 1814,79€ |
| 102.01.132 | 4,0 | 3,0 | 75 m3/h | 15,0 m | 1943,97€ |
| 102.01.133 | 5,0 | 4,0 | 95 m3/h | 16,5 m | 2076,30€ |
| 102.01.134 | 7,5 | 5,5 | 105 m3/h | 22,0 m | 2756,85€ |
| 102.01.135 | 10,0 | 7,5 | 130 m3/h | 22,0 m | 3226,31€ |

VIRON



The Viron Series is a powerful recirculation pump engineered for demanding applications such as public and competition swimming pools. Equipped with a high-technology, energy-efficient motor and a robust thermoplastic casing, it delivers reliable performance while optimizing operating costs.

Designed for stable and continuous operation, each Viron pump is individually tested under normal working conditions prior to packaging, ensuring consistent quality and long-term reliability. A built-in drain valve allows for easy maintenance and safe water evacuation.

Key Advantages:

- High-technology, economical motor
- Stable and reliable operation
- Integrated drain valve for easy maintenance
- Durable thermoplastic casing

The Viron Series is the ideal solution for professional pool installations where performance, efficiency, and durability are essential.

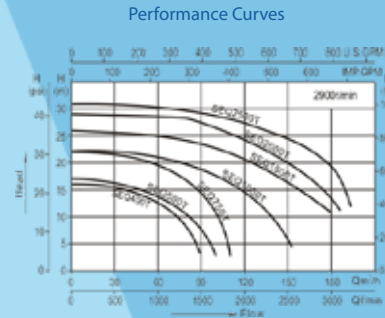
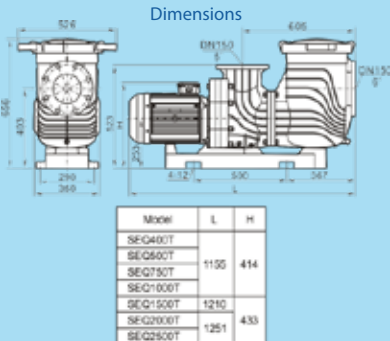

| CODE | POWER | | Q max | H max | PRICE |
|------------|-------|------|----------|--------|----------|
| | hP | kW | | | |
| 102.01.124 | 4,0 | 3,0 | 85 m3/h | 16,0 m | 3887,95€ |
| 102.01.125 | 5,0 | 4,0 | 100 m3/h | 17,0 m | 4152,61€ |
| 102.01.126 | 7,5 | 5,5 | 110 m3/h | 22,0 m | 5513,70€ |
| 102.01.127 | 10,0 | 7,5 | 155 m3/h | 22,0 m | 6452,63€ |
| 102.01.139 | 12,5 | 9,5 | 168 m3/h | 24,0 m | 7077,63€ |
| 102.01.128 | 15,0 | 11,0 | 180 m3/h | 26,0 m | 7952,00€ |
| 102.01.129 | 20,0 | 15,0 | 185 m3/h | 29,0 m | 8827,00€ |
| 102.01.130 | 25,0 | 18,5 | 200 m3/h | 31,0 m | 9700,00€ |

STORM



The Storm Series is a powerful and reliable water circulator, designed to deliver high performance while maintaining excellent energy efficiency. Equipped with a high-tech motor, it ensures strong and consistent circulation with economical operation.

Built with a durable thermoplastic housing, the Storm Series offers long-term resistance and stability in demanding pool environments. Each pump is individually tested after production, guaranteeing dependable operation and quality performance.

Performance curves

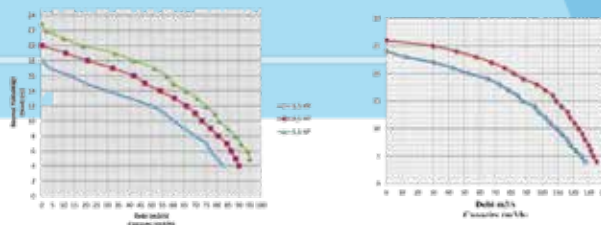

| CODE | POWER | | Q max | H max | PRICE |
|-----------|-------|------|----------|-------|----------|
| | hP | kW | | | |
| 106.07.10 | 3,5 | 2,6 | 83 m3/h | 18 m | 2087,01€ |
| 106.07.11 | 4,5 | 3,3 | 90 m3/h | 20 m | 2235,57€ |
| 106.07.12 | 5,5 | 4,0 | 95 m3/h | 23 m | 2387,75€ |
| 106.07.13 | 7,5 | 5,5 | 130 m3/h | 24 m | 3170,38€ |
| 106.07.14 | 10,0 | 7,3 | 145 m3/h | 27 m | 3710,26€ |
| 106.07.20 | 12,5 | 9,2 | 155 m3/h | 30 m | 4833,33€ |
| 106.07.21 | 15,0 | 11,0 | 180 m3/h | 33 m | 6955,67€ |



The Storm Series is a powerful and reliable water circulator, designed to deliver high performance while maintaining excellent energy efficiency. Equipped with a high-tech motor, it ensures strong and consistent circulation with economical operation.

Built with a durable thermoplastic housing, the Storm Series offers long-term resistance and stability in demanding pool environments. Each pump is individually tested after production, guaranteeing dependable operation and quality performance.

Performance curves

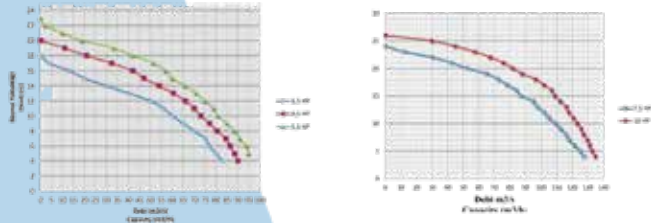

| CODE | POWER | | Q max | H max | PRICE |
|-----------|-------|------|----------|-------|----------|
| | hP | kW | | | |
| 106.07.15 | 3,5 | 2,6 | 84 m³/h | 19 m | 1750,04€ |
| 106.07.16 | 4,5 | 3,3 | 87 m³/h | 21 m | 1880,49€ |
| 106.07.17 | 5,5 | 4,0 | 99 m³/h | 23 m | 2010,93€ |
| 106.07.18 | 7,5 | 5,5 | 140 m³/h | 26 m | 2833,42€ |
| 106.07.19 | 10,0 | 7,3 | 155 m³/h | 29 m | 3337,05€ |
| 106.07.22 | 12,5 | 9,2 | 160 m³/h | 33 m | 4097,94€ |
| 106.07.23 | 15,0 | 11,0 | 190 m³/h | 36 m | 6489,67€ |



Counter Swimming Pump

The Rocket Series pump is a powerful and reliable circulator, specially designed for counter swimming systems. Equipped with a high-tech motor, it delivers impressive performance while maintaining excellent energy efficiency. Its robust thermoplastic housing ensures long-lasting durability, making it ideal for demanding pool applications.

Each Rocket Series pump is individually tested after production, guaranteeing consistent quality, operational safety, and dependable performance. The pump's stable posture and integrated drain plug allow for easy installation, maintenance, and seasonal servicing.

Designed specifically for liner swimming pools, the Rocket Series combines power, efficiency, and reliability—making it a trusted solution for both professional and residential pool installations.

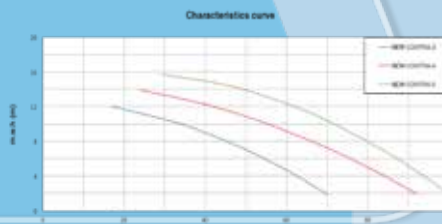

| CODE | DESCRIPTION | hP | kW | POWER | Q max | H | PRICE |
|------------|-------------|-----|-----|-------|---------|-----|----------|
| 106.07.297 | Pump only | 3 | 2,2 | 220V | 42 m³/h | 8m | 1405,41€ |
| 106.07.298 | Pump only | 3,5 | 2,5 | 400V | 46 m³/h | 8 m | 1473,94€ |
| 106.07.299 | Pump only | 4,0 | 3,0 | 400V | 68 m³/h | 8 m | 1544,30€ |
| 106.07.300 | Pump only | 5,5 | 4,0 | 400V | 84 m³/h | 8 m | 1614,66€ |

SEA - WATER

| CODE | DESCRIPTION | hP | kW | POWER | Q max | H | PRICE |
|---------------|-------------|-----|-----|-------|---------|-----|-----------|
| 106.07.297.SW | Pump only | 3 | 2,2 | 220V | 42 m³/h | 8m | 1911,38 € |
| 106.07.298.SW | Pump only | 3,5 | 2,5 | 400V | 46 m³/h | 8 m | 2004,54 € |
| 106.07.299.SW | Pump only | 4,0 | 3,0 | 400V | 68 m³/h | 8 m | 2100,22 € |
| 106.07.300.SW | Pump only | 5,5 | 4,0 | 400V | 84 m³/h | 8 m | 2195,93 € |



Designed specifically for SPAs, the Whirlpool Series Pump is the ideal solution for both circulation and bathtub applications. It is perfectly suited for hydromassage bathtubs and spa systems, ensuring reliable water flow and consistent performance.

Engineered to handle weakly corrosive liquids, including mild acids and alkalis, the pump is intended for use with clean liquids free of solid particles. Its overcurrent components are manufactured from high-strength engineering plastics, providing excellent durability and resistance over time.

Equipped with a high-quality, wear-resistant mechanical seal, the Whirlpool Series Pump delivers long service life, efficient operation, and dependable performance—making it a reliable choice for modern spa and whirlpool installations.

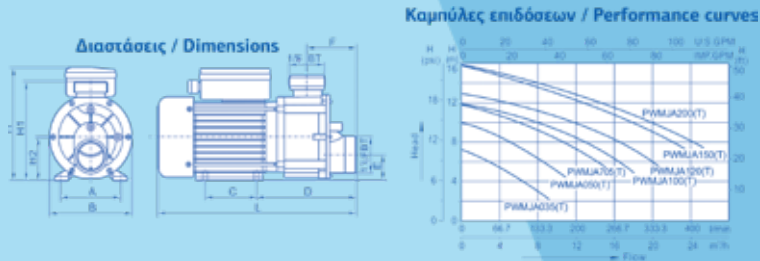

| CODE | Fitting | POWER | | Q max | H max | PRICE |
|------------|---------|-------|------|---------|-------|---------|
| | | hP | kW | | | |
| 106.07.151 | Ø50 | 0,50 | 0,37 | 11 m³/h | 9 m | 299,02€ |
| 106.07.152 | Ø50 | 0,75 | 0,55 | 15 m³/h | 12 m | 344,74€ |
| 106.07.153 | Ø50 | 1,00 | 0,75 | 18 m³/h | 12 m | 471,38€ |
| 106.07.154 | Ø50 | 1,20 | 0,90 | 21 m³/h | 13 m | 488,98€ |
| 106.07.155 | Ø50 | 1,50 | 1,10 | 23 m³/h | 16 m | 545,24€ |
| 106.07.156 | Ø50 | 2,00 | 1,50 | 26 m³/h | 16 m | 587,47€ |



The CITY Series Spa Pool Pump is the preferred choice for spa and pool applications, widely recognized and trusted by SPA manufacturers. Designed with a high-performance volute casing, it delivers a powerful flow rate while maintaining exceptionally low noise levels—ideal for comfort-focused spa environments.

Equipped with 2" inlet and outlet connections, the pump housing allows 90° flexible installation, ensuring easy and adaptable pipework integration. All liquid-contact components are manufactured from high-reinforced engineering plastic, offering excellent durability and resistance to wear.

A high-quality mechanical seal ensures reliable watertight performance, even during long-term continuous operation. Combining efficiency, quiet operation, and installation flexibility, the CITY Series stands as a dependable and proven solution for modern spa systems.

Dimensions

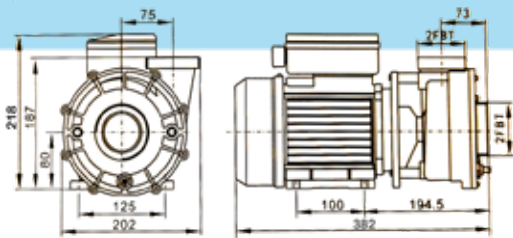

Performance Curves

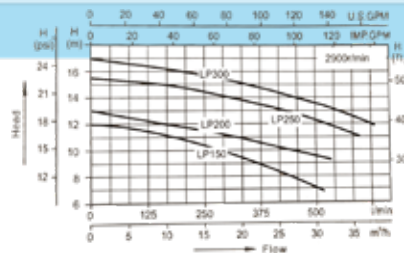

| CODE | Model | Fitting | POWER | | Q max | H max | PRICE |
|------------|--------|---------|-------|------|---------|-------|----------|
| | | | hP | kW | | | |
| 106.07.134 | CLP150 | Ø63 | 1,50 | 1,10 | 28 m³/h | 12 m | 586,00 € |
| 106.07.135 | CLP200 | Ø63 | 2,00 | 1,50 | 32 m³/h | 12 m | 604,00 € |
| 106.07.139 | CLP250 | Ø63 | 2,50 | 2,20 | 38 m³/h | 12 m | 646,00 € |



The DS Dual Speed Series is a reliable and efficient two-speed pump designed specifically for spa and wellness pools. It offers high-speed operation for powerful hydromassage and low-speed mode for filtration and continuous water recirculation, ensuring optimal performance and energy efficiency in everyday use.

Featuring a high-performance volute casing, the DS pump delivers a large flow rate while maintaining low noise levels, contributing to a comfortable and relaxing spa environment. The pump is equipped with 2" inlet and outlet connections, and its housing allows 90° vertical installation, making pipework easier and more flexible, even in compact technical spaces.

All fluid-contact components are manufactured from high-reinforcement engineering plastic, combined with a mechanical seal system that guarantees excellent watertightness and durability during long-term, continuous operation. Thanks to its robust construction and proven reliability, the DS Dual Speed Series is widely recognized and approved by spa manufacturers.

A dependable solution for modern spa systems, the DS Dual Speed pump combines performance, efficiency, and installation flexibility in one compact design.



Dimensions

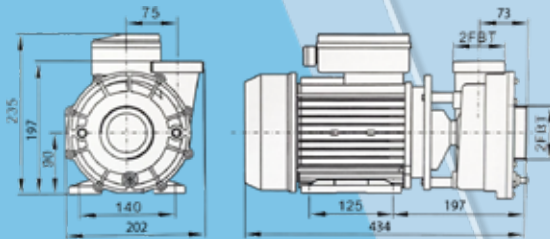

Performance Curves

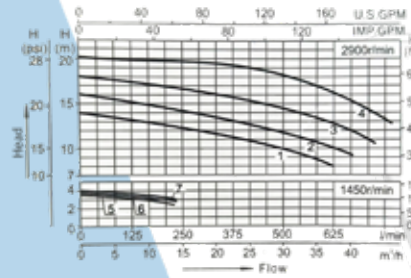

| CODE | Model | Fitting | POWER | | Q max | H max | Chart Curve | PRICE |
|------------|------------|---------|-------------|-------------|--------------|------------|-------------|------------|
| | | | hP | kW | | | | |
| 106.07.136 | DSWP200-II | Ø63 | 0,40 - 2,00 | 0,35 - 1,50 | 16 - 37 m³/h | 3,5 - 14 m | 5 - 1 | 1.238,00 € |
| 106.07.137 | DSWP250-II | Ø63 | 0,50 - 2,50 | 0,40 - 1,85 | 18 - 40 m³/h | 3,5 - 16 m | 6 - 2 | 1.346,00 € |



Low Noise Recirculation Spa Pump 1400rpm

The LoW Series recirculation pump is engineered specifically for spa applications where performance, reliability, and silence are essential. Designed with an advanced volute pump casing, the LoW Series delivers high efficiency and large flow rates while maintaining exceptionally low noise levels, making it a preferred solution for leading spa manufacturers worldwide.

The optimized volute design maximizes hydraulic performance and ensures whisper-quiet operation, even during continuous use. Featuring a Ø50 inlet and outlet, along with a 90° vertical installation option, the pump allows fast, flexible, and effortless pipe connections.

Constructed from high-reinforced engineering plastic, the LoW Series offers outstanding durability and resistance to wear and tear. A high-quality mechanical seal guarantees a reliable, watertight seal, ensuring long-term, trouble-free operation.

Trusted globally by spa professionals, the LoW Series combines silent performance, robust construction, and installation flexibility—making it the ideal choice for modern spa systems.



Dimensions

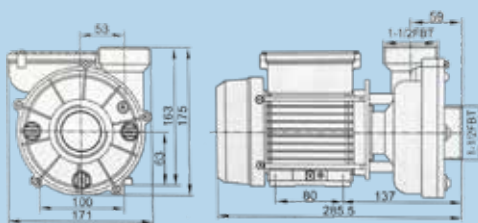

Performance Curves

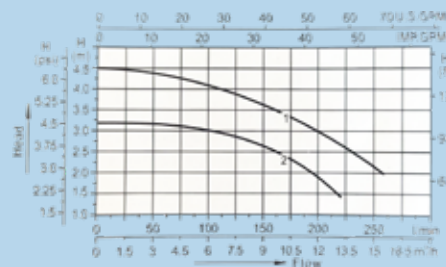

| CODE | Model | Fitting | R.P.M. | POWER | | Q max | H max | Chart Curve | PRICE |
|------------|----------|---------|--------|-------|------|---------|-------|-------------|----------|
| | | | | hP | kW | | | | |
| 106.07.138 | LoWTS50M | Ø50 | 1400 | 0,30 | 0,22 | 16 m³/h | | 1 | 485,00 € |

i-Saver Inverter



The i-SAVER pool pump frequency inverter is an intelligent and cost-effective solution designed to dramatically reduce energy consumption and lower the operating costs of swimming pool circulation systems. Specifically engineered for single-speed pool pumps, i-SAVER transforms standard pump operation into an energy-efficient, adjustable-speed system without the need to replace the existing pump.

By precisely controlling the motor speed according to the real filtration and circulation needs of the pool, i-SAVER eliminates unnecessary power usage while maintaining optimal water quality. This smart regulation results in significant energy savings, improved hydraulic efficiency, and a noticeably quieter pump operation.

In addition to reducing electricity costs, i-SAVER helps extend the lifespan of the pool pump and its components by minimizing mechanical stress, overheating, and wear caused by continuous full-speed operation. The inverter ensures smooth start-up and stable performance, offering enhanced protection for the motor and electrical system.

Designed for easy integration into both residential and commercial swimming pools, the i-SAVER frequency inverter is a practical upgrade for new installations and renovations alike. Its reliability, affordability, and performance make it an excellent choice for pool professionals and end users looking to improve system efficiency without high investment costs. With i-SAVER, Oxygen delivers a smart energy-saving solution that combines efficiency, durability, and cost control, helping pool owners achieve optimal performance with reduced environmental impact.

| CODE | DESCRIPTION | PRICE |
|------------|---------------------------------|---------|
| 106.07.285 | i-Saver for pumps 0,5hp - 1,5hp | 793,51€ |
| 106.07.286 | i-Saver for pumps 1,5hp - 3,0hp | 847,85€ |

Plastic Pump Base



Fiberglass Pump Base



Oxygen offers a complete range of pump bases in multiple sizes, designed to ensure stable, safe, and long-lasting installation of pool pumps and equipment.

Our plastic pump bases are a cost-effective solution, ideal for standard installations where affordability and functionality are key. They are lightweight, easy to handle, and resistant to moisture, making them a practical choice for many pool systems.

For more demanding environments, fiberglass pump bases provide enhanced durability and superior structural strength. Built to withstand heavier loads and long-term use, they offer increased resistance to wear, vibration, and environmental stress, ensuring reliable performance over time.

Whether you prioritize budget efficiency or maximum durability, Oxygen pump bases deliver a dependable foundation tailored to every installation need.

| CODE | DESCRIPTION | WEIGHT | DIMENSION | PRICE |
|-----------|------------------------|----------|----------------|---------|
| 106.23.05 | 1 PLASTIC PUMP BASE | 1,20 kg | 0,20x0,43x0,28 | 101,97€ |
| 106.23.01 | 1 FIBERGLASS PUMP BASE | 2,35 kg | 0,20x0,55x0,34 | 155,81€ |
| 106.23.02 | 2 FIBERGLASS PUMP BASE | 4,70 kg | 0,20x1,02x0,34 | 253,64€ |
| 106.23.03 | 3 FIBERGLASS PUMP BASE | 12,00 kg | 0,26x0,90x0,60 | 420,31€ |
| 106.23.04 | 4 FIBERGLASS PUMP BASE | 14,50 kg | 0,26x1,80x0,60 | 561,60€ |



Filters - Φίλτρα

Ester



The ESTER series sand filters are designed to deliver reliable and efficient water filtration for swimming pools of all sizes. Fabricated from high-quality polyester, these filters offer excellent resistance, durability, and long-term performance, even under demanding operating conditions.

Available in a wide range of dimensions, from D500 to D920, the ESTER series provides flexible solutions for both residential and commercial pool installations. Each filter is supplied with a manual multiport valve, ensuring easy operation, precise control, and efficient maintenance.

Fully compliant with European standards, the ESTER sand filters are CE certified, guaranteeing safety, quality, and performance you can trust.

DIMENSIONS

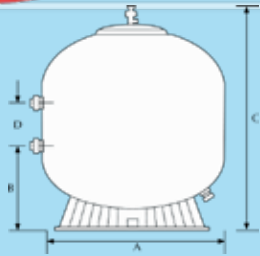

| MODEL | A | B | C | D |
|-------|------|--------|-------|--------|
| Ø400 | 50cm | 28cm | 70cm | 12,5cm |
| Ø500 | 50cm | 28cm | 70cm | 12,5cm |
| Ø620 | 65cm | 31,5cm | 92cm | 14,5cm |
| Ø760 | 80cm | 37cm | 111cm | 18cm |
| Ø920 | 95cm | 37cm | 111cm | 20cm |

| CODE | DESCRIPTION | FLOW | CONNECTION | SAND WEIGHT | UNIT WEIGHT | PRICE |
|-----------|-------------|---------|------------|-------------|-------------|----------|
| 102.01.09 | Ø400 | 8 m³/h | Ø50 | 60kg | 10kg | 706,53€ |
| 102.01.10 | Ø500 | 10 m³/h | Ø50 | 75kg | 13kg | 764,51€ |
| 102.01.11 | Ø620 | 15 m³/h | Ø50 | 150kg | 24kg | 858,70€ |
| 102.01.12 | Ø760 | 22 m³/h | Ø63 | 350kg | 35kg | 1231,91€ |
| 102.01.13 | Ø920 | 30 m³/h | Ø63 | 450kg | 44kg | 1641,34€ |

Bobbin Wound



Engineered for durability and superior filtration, the Oxygen BobbinWound Residential Series side-mount filters deliver long-lasting performance you can rely on. Constructed using high-strength polyester resin and non-corrosive fiberglass filament winding, these filters are built to withstand demanding residential pool environments.

All internal components and hydraulic connections are manufactured from injection-molded PVC, ensuring excellent chemical resistance and reliable operation over time. Thanks to their optimized internal design, the BobbinWound filters achieve a higher filtered water volume while requiring less pump horsepower—offering both energy efficiency and outstanding water clarity.

The UV-resistant exterior finish allows safe outdoor installation, even under direct sunlight, without compromising structural integrity or appearance. Each unit is supplied with a high-quality side-mount multiport valve, ensuring precise flow control and easy operation.

Strong. Efficient. Built to last.

The BobbinWound Residential Series is the smart choice for crystal-clear pool water and long-term peace of mind.

DIMENSIONS

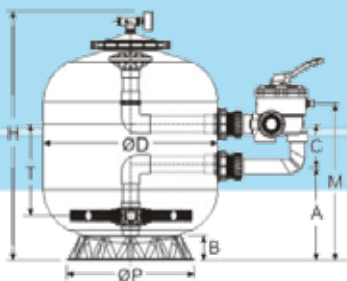

| MODEL | H | A | B | C | M | T |
|-------|-------|--------|-------|--------|--------|------|
| Ø500 | 71cm | 29cm | 7,5cm | 12,5cm | - | - |
| Ø635 | 81cm | 31cm | 9,5cm | 12,5cm | - | - |
| Ø710 | 88cm | 36cm | 9,0cm | 12,5cm | - | - |
| Ø800 | 101cm | 38,5cm | 12cm | 22cm | 68cm | 42cm |
| Ø900 | 110cm | 43cm | 15cm | 22cm | 72,5cm | 48cm |
| Ø1000 | 116cm | 54cm | 15cm | 22cm | 83,5cm | 51cm |
| Ø1200 | 134cm | 54cm | 18cm | 22cm | 83,5cm | 60cm |

| CODE | DESCRIPTION | FLOW | CONNECTION | SAND WEIGHT | UNIT WEIGHT | PRICE |
|------------|-------------|---------|------------|-------------|-------------|----------|
| 102.01.33 | Ø535 | 12 m³/h | 1 1/2" | 80kg | 10,5kg | 679,70€ |
| 102.01.99 | Ø635 | 16 m³/h | 1 1/2" | 160kg | 14,5kg | 791,93€ |
| 102.01.100 | Ø710 | 20 m³/h | 1 1/2" | 220kg | 19,5kg | 1019,70€ |
| 102.01.101 | Ø800 | 25 m³/h | 2" | 380kg | 45,0kg | 1447,57€ |
| 102.01.102 | Ø900 | 30 m³/h | 2" | 450kg | 50,0kg | 1606,31€ |
| 102.01.103 | Ø1000 | 35 m³/h | 2" | 710kg | 70,0kg | 2227,47€ |
| 102.01.104 | Ø1200 | 50 m³/h | 2" | 960kg | 92,0kg | 3090,13€ |



The Oxygen Proton Series sand filters are designed to deliver efficient, long-term filtration for residential and commercial swimming pools. Manufactured from high-density polyethylene, Proton filters are corrosion-proof, environmentally friendly, and engineered for safe operation in all pool environments.

Available with side multivalve or top-mounted multivalve configurations, the Proton Series offers installation flexibility to suit any technical layout. The integrated multi-valve ensures easy operation and maintenance, while the top diffuser system guarantees uniform water distribution across the sand bed, maximizing filtration efficiency and extending media life.

With sizes ranging from Ø450 mm to Ø700 mm, the Proton Series provides reliable performance for a wide variety of pool volumes—combining durability, efficiency, and smart design in one robust solution.

DIMENSIONS

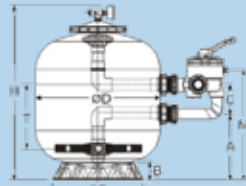

| MODEL | H | A | P | C | G | E |
|-------|------|------|--------|--------|------|------|
| Ø450 | 67cm | 26cm | 39cm | 12,5cm | 75cm | 90cm |
| Ø535 | 71cm | 29cm | 39cm | 12,5cm | 75cm | 90cm |
| Ø635 | 81cm | 31cm | 56,5cm | 12,5cm | 95cm | 90cm |
| Ø710 | 88cm | 36cm | 56,5cm | 12,5cm | 95cm | 95cm |

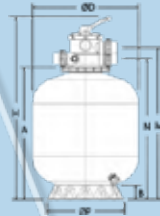

| MODEL | H | A | P | C | G | E |
|-------|------|------|--------|--------|------|------|
| Ø450 | 67cm | 26cm | 39cm | 12,5cm | 75cm | 90cm |
| Ø535 | 71cm | 29cm | 39cm | 12,5cm | 75cm | 90cm |
| Ø635 | 81cm | 31cm | 56,5cm | 12,5cm | 95cm | 90cm |
| Ø710 | 88cm | 36cm | 56,5cm | 12,5cm | 95cm | 95cm |

| CODE | DESCRIPTION | FLOW | CONNECTION | SAND WEIGHT | UNIT WEIGHT | PRICE |
|---------------|-------------|---------|------------|-------------|-------------|---------|
| 102.01.29 | Ø450 | 8 m³/h | Ø50 | 75kg | 7kg | 449,28€ |
| 102.01.30 | Ø535 | 12 m³/h | Ø50 | 100kg | 11kg | 521,74€ |
| 102.01.31 | Ø635 | 18 m³/h | Ø50 | 175kg | 14kg | 561,60€ |
| 102.01.32 | Ø710 | 22 m³/h | Ø50 | 250kg | 19kg | 786,24€ |
| 102.01.29#top | Ø450 | 8 m³/h | Ø50 | 75kg | 7kg | 430,00€ |
| 102.01.30#top | Ø535 | 12 m³/h | Ø50 | 100kg | 11kg | 500,00€ |
| 102.01.31#top | Ø635 | 18 m³/h | Ø50 | 175kg | 14kg | 540,00€ |



The Premier Series by Oxygen is designed to deliver superior water filtration performance for swimming pools, spas, and water features of all types. Manufactured from high-density polyethylene (HDPE) and using advanced blow-molding technology, Premier filter tanks combine structural strength with long-term reliability, even in demanding weather conditions.

Available with both side multivalve and top-mounted multivalve configurations, the Premier Series adapts easily to different installation needs. Its unique internal structural design, enhanced by a double diffuser, ensures optimal water distribution, improved backwash efficiency, and exceptional water clarity.

With 30% more filtration bed capacity, the Premier filter delivers noticeably higher filtration quality, capturing finer particles and reducing maintenance cycles. Built from environmentally safe, corrosion-proof materials, it is perfectly suited for all types of swimming pools, including saltwater systems.

The Premier Series is also fully compatible with advanced water treatment solutions such as chlorinator generators, UV sterilizers, ozone systems, and chemical dosing equipment, making it a versatile choice for modern pool installations.

Designed with simplicity in mind, the system allows for easy maintenance and component replacement, with no tools required for operation or servicing.

Key benefits:

- Available with side or top multivalve
- HDPE construction with blow-molding technology
- 30% increased filtration bed for superior performance
- Double diffuser for improved flow and backwash
- Weather-resistant, corrosion-proof, and eco-friendly materials
- Tool-free operation and maintenance
- Compatible with chlorination, UV, ozone, and dosing systems
- Suitable for pools, spas, and water features

The Oxygen Premier Series sets a new standard in filtration efficiency, reliability, and ease of use—engineered for professionals who demand performance without compromise.

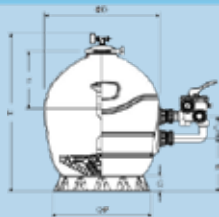

| MODEL | H | A | C | G | F | B | N | M |
|----------|-----|-----|-----|----|-----|----|-----|-----|
| Ø500 | 736 | 241 | 125 | 75 | 236 | - | - | - |
| Ø600 | 830 | 310 | 125 | 75 | 285 | - | - | - |
| Ø650 | 887 | 296 | 125 | 90 | 319 | - | - | - |
| Ø425#top | 767 | - | - | - | 195 | 75 | 579 | 635 |
| Ø500#top | 890 | - | - | - | 236 | 75 | 702 | 758 |

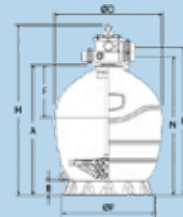

| CODE | DESCRIPTION | FLOW | CONNECTION | SAND | WEIGHT | PRICE |
|----------------|----------------|---------|------------|-------|--------|---------|
| 102.01.96 | Ø500 | 10 m³/h | 1 1/2" | 90kg | 13,3kg | 665,18€ |
| 102.01.97 | Ø600 | 15 m³/h | 1 1/2" | 140kg | 16,2kg | 753,11€ |
| 102.01.98 | Ø650 | 19 m³/h | 1 1/2" | 170kg | 19kg | 917,73€ |
| 102.01.900#top | Ø425 Top Mount | 7 m³/h | 1 1/2" | 50kg | 9,8kg | 585,15€ |
| 102.01.96#top | Ø500 Top Mount | 9,5m³/h | 1 1/2" | 90kg | 12,3kg | 635,18€ |

- SPA - Compact

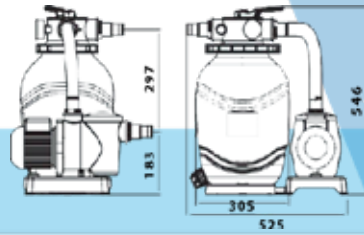

The Spa Compact Filter + Pump Series is a complete filtration solution specially designed for domestic swimming pools and spas, where reliability, efficiency, and ease of installation are essential.

Its compact and intelligently engineered design allows for quick assembly and straightforward operation, making installation both fast and hassle-free. Multiple connection options are included, ensuring flexible integration across a wide range of pool and spa configurations.

The sand filter and pump are perfectly matched to work together, delivering optimal hydraulic performance and high filtration efficiency while maintaining low energy consumption. Built for durability and safety, the pump features Class F insulation and IPX5 protection, ensuring dependable operation even in demanding environments.

A smart, compact, and efficient choice—Spa Compact delivers everything you need for clean, clear water with minimal effort.

| CODE | DESCRIPTION | FLOW | CONNECTION | SAND WEIGHT | PRICE |
|------------|---------------|-----------------------|------------|-------------|----------|
| 102.01.115 | Ø300 - 0,35hp | 6,5 m ³ /h | 1 1/2" | 25kg | 520,00 € |

ECO

Food Grade

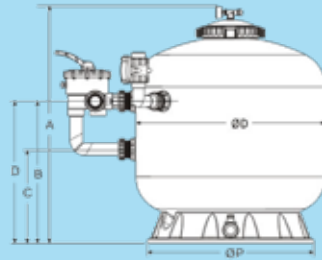

ECO filters are closed pressure filters containing food grade polyethylene granules or beads. The form and size of the beads create a large surface on which bacteria and suspended solids can be attached. It provides mechanical and biological filtration at a single unit which is combined with bobbin wound filter, 6-way multiport valve, pipings, circulation pump, air blower, control box and base. It has been engineered uniquely for ponds and aquariums.

DIMENSIONS

| MODEL | A | B | C | E | P |
|-------|--------|--------|--------|--------|--------|
| Ø450 | 66cm | 38,5cm | 26cm | 38,5cm | 39cm |
| Ø500 | 73cm | 40,5cm | 28cm | 40,5cm | 39cm |
| Ø650 | 79cm | 43,5cm | 31cm | 43,5cm | 56,5cm |
| Ø700 | 88,5cm | 52cm | 30cm | 48cm | 56,5cm |
| Ø800 | 102cm | 60,5cm | 38,5cm | 60cm | 79cm |
| Ø900 | 111cm | 65cm | 43cm | 65cm | 79cm |
| Ø1200 | 135cm | 82cm | 60cm | 82cm | 101cm |

| CODE | DESCRIPTION | FLOW | POND SIZE | FISH LOAD | FOOD (PR) | PRICE |
|-----------|-------------------------|----------------------|--------------------|-----------|-----------|----------|
| 102.01.80 | Ø450 +400Wblower | 8 m ³ /h | 6 m ³ | 20kg | 200 | 1880,49€ |
| 102.01.81 | Ø500 +400Wblower | 11 m ³ /h | 10 m ³ | 35kg | 350 | 1989,18€ |
| 102.01.82 | Ø650 +400Wblower | 16 m ³ /h | 30 m ³ | 78kg | 780 | 2206,57€ |
| 102.01.83 | Ø700 +900Wblower | 19 m ³ /h | 34 m ³ | 94kg | 940 | 2496,43€ |
| 102.01.84 | Ø800 +900Wblower | 25 m ³ /h | 52 m ³ | 124kg | 1240 | 2895,00€ |
| 102.01.85 | Ø900 +1000Wblower | 30 m ³ /h | 73 m ³ | 172kg | 1720 | 3221,12€ |
| 102.01.86 | Ø1200 + 2 X 1000Wblower | 42 m ³ /h | 148 m ³ | 310kg | 3100 | 6155,97€ |

Cartridge Filters



The Oxygon Cartridge Filter Series offers reliable and efficient filtration for swimming pools and spas in a compact, lightweight design. The UV-resistant tank ensures long-lasting durability, while the heavy-duty ring-lock lid allows quick and easy cartridge cleaning or replacement.

Equipped with a screw-type air bleeder for easy air removal and a high-quality oil-filled pressure gauge for clear pressure monitoring, the filter is built for safe and simple operation. It supports a maximum working pressure of 2.5 bar and a maximum water temperature of 40°C, delivering consistent performance in everyday use.



| CODE | TANK DIAMETER | TANK HEIGHT | FLOW | CONNECTION | MICRON | FILTER AREA | PRICE |
|-----------|---------------|-------------|------------------------|------------|--------|---------------------|---------|
| 103.08.01 | 225 | 548.3mm | 11,4 m ³ /h | Ø63 | ≤15 | 4,63 m ² | 721,04€ |

| CODE | ELEMENT DIAMETER | ELEMENT HEIGHT | TANK CODE | PRICE |
|------------|------------------|----------------|-----------|---------|
| 103.08.01R | 183mm | 364,5mm | 103.08.01 | 300,75€ |



The Oxygen Bobbin Wound Commercial Series sand filters are designed for reliable performance in commercial swimming pool applications. Manufactured from high-quality fiberglass-reinforced polyester, they offer excellent strength and long-term durability.

Available in diameters from Ø1200 to Ø2500, the filters include a pressure gauge and air purge, with all internal components made from high-quality PVC. Supplied without multivalve, they allow flexible system integration.

The series is available with laterals or with nozzles and operates at a filtration rate of 40 m³/h/m². Versions compliant with DIN 19605 / DIN 19643 are available upon request.

Optional: Sight glass, manhole, nozzle plate, Manometer Panel

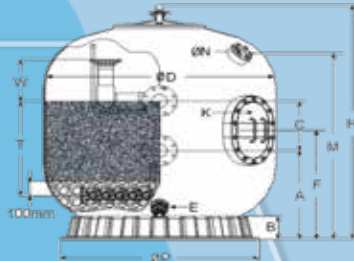

| | 1200 | 1400 | 1800 | 1800 | 2000 | 2300 | 2500 |
|--------|---------|---------|---------|---------|---------|---------|---------|
| D (mm) | 1200 | 1400 | 1800 | 1800 | 2000 | 2300 | 2500 |
| H (mm) | 1400 | 1600 | 1750 | 1950 | 2140 | 2350 | 2450 |
| A (mm) | 500 | 850 | 600 | 730 | 800 | 940 | 960 |
| B (mm) | 165 | 185 | 215 | 215 | 240 | 240 | 240 |
| C (mm) | 340 | 350 | 450 | 550 | 550 | 600 | 600 |
| E (mm) | 60 | 60 | 60 | 60 | 60 | 60 | 60 |
| F (mm) | 740 | 800 | 875 | 810 | 1050 | 1070 | 1100 |
| K (mm) | 180x180 | 400x300 | 400x300 | 400x300 | 400x300 | 450x300 | 450x350 |
| N (mm) | 1150 | 1250 | 1450 | 1850 | 1700 | 1800 | 1900 |
| N (mm) | 80 | 80 | 80 | 80 | 80 | 80 | 80 |
| P (mm) | 500 | 1215 | 1450 | 1850 | 1800 | 2010 | 2100 |
| T (mm) | 600 | 700 | 800 | 850 | 900 | 1000 | 1050 |
| W (mm) | 200 | 300 | 320 | 320 | 350 | 450 | 400 |

| CODE | DESCRIPTION | FLOW | FILTER AREA | PIPE | SAND WEIGHT | GRAVEL WEIGHT | UNIT WEIGHT | PRICE |
|-----------|-------------|-----------------------|---------------------|-----------------|-------------|---------------|-------------|-----------|
| 102.01.50 | Ø1200 | 45 m ³ /h | 1,13 m ² | 3" | 1250kg | 300kg | 122kg | 6485,69€ |
| 102.01.51 | Ø1400 | 61 m ³ /h | 1,54 m ² | 4" | 1760kg | 500kg | 146kg | 8297,32€ |
| 102.01.52 | Ø1600 | 80 m ³ /h | 2,01 m ² | 4" | 2450kg | 750kg | 200kg | 10108,96€ |
| 102.01.53 | Ø1800 | 101 m ³ /h | 2,54 m ² | 6" | 3100kg | 750kg | 313kg | 11558,26€ |
| 102.01.54 | Ø2000 | 125 m ³ /h | 3,14 m ² | 6" | 3800kg | 1150kg | 385kg | 14094,57€ |
| 102.01.55 | Ø2300 | 175 m ³ /h | 4,34 m ² | 8" | 5275kg | 1800kg | 538kg | 21703,46€ |
| 102.01.56 | Ø2500 | 200 m ³ /h | 4,90 m ² | 8" | 5950kg | 2200kg | 781kg | 26776,07€ |
| 102.01.57 | | | | Manhole | | | | 2155,86€ |
| 102.01.58 | | | | Sight Glas | | | | 815,25€ |
| 102.01.59 | | | | Manometer panel | | | | 648,58€ |
| 102.01.60 | | | | Cover Lid | | | | 887,72€ |



Designed for reliability and high efficiency, Oxygen's Sand Filter is the ideal choice for maintaining crystal-clear water in any swimming pool. Made with premium materials and engineered to meet rigorous standards, this sand filter provides long-lasting performance and easy maintenance, giving pool owners peace of mind and outstanding water quality.

Constructed from premium-quality polyester for enhanced durability and performance. Available in a range of sizes, from D1050 to D2000, to suit various pool capacities.

Compatible with multiple valve types (multivalve not included).

Certified with CE marking, ensuring compliance with European safety and quality standards.

DIMENSIONS

| MODEL | A | B | C | D |
|-------|-------|--------|-------|---|
| Ø1050 | 105cm | 45cm | 115cm | - |
| Ø1250 | 125cm | 52cm | 143cm | - |
| Ø1400 | 140cm | 66cm | 160cm | - |
| Ø1600 | 160cm | 70,5cm | 185cm | - |
| Ø2000 | 200cm | 85cm | 203cm | - |

| CODE | DESCRIPTION | FLOW m ³ /h/m ² 30 / 40 / 50 | CONNECTION | SAND WEIGHT | UNIT WEIGHT | PRICE |
|-----------|-------------|---|------------|-------------|-------------|-----------|
| 102.01.14 | Ø1050 | 25 - 34 - 43 m ³ /h | Ø90 | 750kg | 80 kg | 2949,35€ |
| 102.01.15 | Ø1250 | 33 - 45 - 52 m ³ /h | Ø90 | 950kg | 130 kg | 3416,76€ |
| 102.01.16 | Ø1400 | 45 - 60 - 80 m ³ /h | Ø110 | 1900kg | 195 kg | 4514,61€ |
| 102.01.17 | Ø1600 | 60 - 80 - 100 m ³ /h | Ø110-125 | 3650kg | 230 kg | 5188,53€ |
| 102.01.18 | Ø2000 | 94 - 125 - 157 m ³ /h | Ø160 | 4200kg | 320 kg | 10040,13€ |



The Olympus Deep Bed series represents Oxygen's commitment to durability, efficiency, and advanced pool water filtration. Designed for demanding residential and commercial applications, these filters combine robust construction with reliable performance over time.

Manufactured with a monobloc polyester and fiberglass body, reinforced with polyester fibers, the Olympus Deep Bed filters offer exceptional mechanical strength and long-term resistance to pressure and chemical stress. The deep bed design, with a 1.2 m bed depth, ensures superior filtration capacity and optimal water clarity.

Available in a wide range of sizes, from D620 to D1050, the series adapts seamlessly to various pool volumes and hydraulic requirements. Each unit is supplied complete with a multi-valve, pressure gauge, and air purge, ensuring easy installation, precise control, and safe operation.

Engineered to withstand a test pressure of 4 kg/cm² and an operating pressure of 2.5 kg/cm², the Olympus Deep Bed series delivers consistent performance and reliability, even under intensive working conditions.

DIMENSIONS

| MODEL | H1 | H2 | H3 | H4 | H5 | H6 | H7 |
|-------|---------|---------|--------|--------|--------|---------|---------|
| Ø620 | 196,0cm | 190,0cm | 60,0cm | 17,0cm | 32,0cm | 134,0cm | 126,0cm |
| Ø800 | 198,5cm | 192,5cm | 80,0cm | 17,0cm | 35,0cm | 137,0cm | 131,0cm |
| Ø920 | 213,0cm | 207,0cm | 98,0cm | 21,0cm | 55,0cm | 154,0cm | 124,0cm |
| Ø1050 | - | - | - | - | - | - | - |
| Ø1250 | - | - | - | - | - | - | - |

| CODE | DESCRIPTION | FLOW 30m ³ /h/m ² | FLOW 40m ³ /h/m ² | MULTIVALVE | SAND | PRICE |
|------------|-------------|--|--|---------------|-------|----------|
| 102.01.92N | Ø620 | 9 m ³ /h | 12 m ³ /h | Included 1/2" | 200kg | 2100,00€ |
| 102.01.93N | Ø800 | 15 m ³ /h | 20 m ³ /h | Included 2" | 275kg | 2500,00€ |
| 102.01.94N | Ø920 | 20 m ³ /h | 26,5 m ³ /h | Included 2" | 400kg | 3500,00€ |
| 102.01.95N | Ø1050 | 26 m ³ /h | 34 m ³ /h | Not Included | 450kg | 4500,00€ |
| 102.01.96N | Ø1250 | 36 m ³ /h | 48 m ³ /h | Not Included | 675kg | 5200,00€ |

Glass Sand Oxygen



Filter's media & Accessories



Quartz Sand Oxygen



| CODE | DESCRIPTION | PRICE |
|-----------|---|-------------|
| 102.09.00 | Quartz Sand 0,5-0,8 25kg bag | 0,82 € / kg |
| 102.09.02 | Quartz Sand 0,8-1,2 25kg bag | 0,77 € / kg |
| 102.09.19 | Glass 0,5-1,4 25kg bag | 2,35 € / kg |
| 102.04.01 | Manometer for Sand Filters 3 bar | 18.13€ |
| 102.04.02 | Elbow for Manometer of 3 bar | 54.33€ |
| 102.02.01 | Air Reliever | 14.49€ |
| 102.03.05 | Filter lid in dimensions from Ø300 up to Ø920 | 65.23€ |
| 102.10.00 | Filter lid O-ring | 28.98€ |
| 104.25.02 | SS316 filter ring for filter baskets | 235.52€ |

Fiberglass Trap Doors



Διαστάσεις / Dimensions

| | A | B | C | D | E |
|------------|------|------|--------|-------|-------|
| 90 x 90 cm | 5 cm | 4 cm | 108 cm | 87 cm | 90 cm |
| 75 x 75 cm | 5 cm | 4 cm | 90 cm | 69 cm | 75 cm |
| 60 x 60 cm | 5 cm | 4 cm | 73 cm | 52 cm | 60 cm |

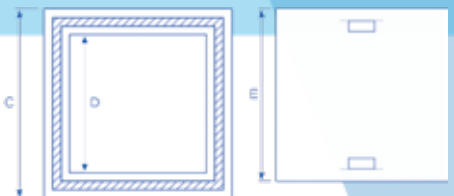

| CODE | DESCRIPTION | DIMENSION | PRICE |
|-----------|-------------------|----------------|----------|
| 104.26.05 | Polyester 60X60 | 0,06X0,07X0,75 | 420,31€ |
| 104.26.06 | Polyester 75X75 | 0,06X0,07X0,95 | 568,85€ |
| 104.26.07 | Polyester 90X90 | 0,06X0,07X1,10 | 1344,22€ |
| 104.26.08 | Polyester 100X100 | 0,06X0,07X1,15 | 1492,79€ |

Multivalves

Maximum operating pressure 3,5bar (50PSI). Available in three different sizes



| CODE | DESCRIPTION | PRICE |
|-----------|---|----------|
| 102.07.01 | Ø50 sided mounted 6way valve with 1 1/2" thread | 112,32€ |
| 102.07.02 | sided mounted 6way valve with Ø50 connection | 134,05€ |
| 102.07.03 | Ø63 sided mounted 6way valve with 2" thread | 163,06€ |
| 102.07.04 | sided mounted 6way valve with Ø63 connection | 188,43€ |
| 102.07.05 | 1 1/2" top mounted 6way valve | 134,05€ |
| 102.07.06 | 2" top mounted 6way valve | 177,55€ |
| 102.07.07 | Ø75 - 2 1/2", 0,34,0,30x0,44 | 858,70€ |
| 102.07.08 | Ø90 - 3", 0,40,0,30,x0,44 | 2055,00€ |

Automated Multivalves

Automatic & Semiautomted side mounted multiway valves with Pressure and Time controller. Adjustable Backwash and Rinse periods.



AS Series



MD Series

| CODE | DESCRIPTION | PRICE |
|-----------|----------------------------|-----------|
| 102.07.31 | 1 1/2" threaded connection | 2726,09€ |
| 102.07.32 | 2" threaded connection | 3071,16€ |
| 102.07.33 | 3" threaded connection | 16183,99€ |
| 102.07.34 | 4" threaded connection | 17219,23€ |

Customised Valves Batteries

- Customised multivalve with 5 valves for fiberglass sand filters
- Including: five (5) butterfly valves mounted on PN10 pipe, PVC PN16 flanges, DIN934 screws, nuts and washers in lane zinc steel



| CODE | DESCRIPTION | FLOW | CONNECTION | PRICE |
|-----------|-------------|---------|------------|----------|
| 102.07.09 | Ø75 | 17 m³/h | Ø75 | 1681,19€ |
| 102.07.10 | Ø90 | 20 m³/h | Ø90 | 2090,64€ |
| 102.07.11 | Ø110 | 22 m³/h | Ø110 | 2652,24€ |
| 102.07.12 | Ø125 | 28 m³/h | Ø125 | 3376,90€ |
| 102.07.13 | Ø140 | 43 m³/h | Ø140 | 4145,04€ |
| 102.07.14 | Ø160 | 46 m³/h | Ø160 | 5449,42€ |

Automated Valves Batteries

- Customised automated multivalve with 5 electro-valves for fiberglass sand filters
- Including: five (5) butterfly electrovalves valves mounted on PN10 pipe, PVC PN16 flanges, DIN934 screws, nuts and washers in lane zinc steel

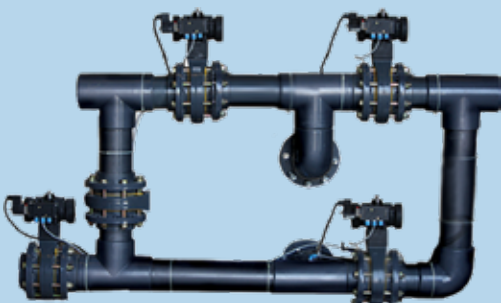

| CODE | DESCRIPTION | FLOW | CONNECTION | PRICE |
|------------|-----------------------------------|---------|------------|----------|
| 102.07.09A | Ø75 | 17 m³/h | Ø75 | 4953,95€ |
| 102.07.10A | Ø90 | 20 m³/h | Ø90 | 5663,68€ |
| 102.07.11A | Ø110 | 22 m³/h | Ø110 | 6004,35€ |
| 102.07.12A | Ø125 | 28 m³/h | Ø125 | 8502,62€ |
| 102.07.13A | Ø140 | 43 m³/h | Ø140 | 9070,41€ |
| 102.07.14A | Ø160 | 46 m³/h | Ø160 | 9638,19€ |
| 102.07.40 | Controller for automated bateries | | | 3832,57€ |

Shelby



The housing is made on high quality acryl. The unit is to install and assembles all the equipment for filtration, circulation, disinfection, drainage and lighting in one compact unit. It is also equipped with multifunctional jet which not only circulates the pool water, but also has functions of hydromassage and fun in the water. Extra fit for children pools.

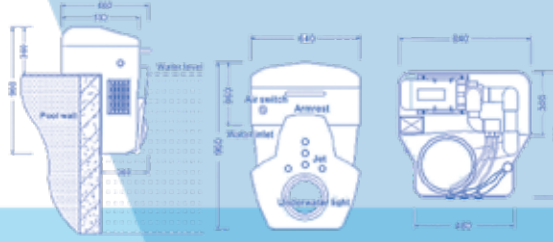

| CODE | PUMP | FLOW | FILTER RECISSION | FILTER AREA | NOISE | OUTLINE SIZE | PRICE |
|-----------|---------|----------------------|------------------|---------------------|---------|---------------|-----------|
| 102.26.11 | 0,75 hp | 10 m ³ /h | < 5m | 0,26 m ² | ≤ 40 db | 640X660X960mm | 4168,52 € |
| 102.26.12 | 1,00 hp | 15 m ³ /h | < 5m | 0,26 m ² | ≤ 40 db | 640X660X960mm | 4347,95 € |
| 102.26.09 | 1,20 hp | 18 m ³ /h | < 5m | 0,26 m ² | ≤ 40 db | 640X660X960mm | 4530,86 € |

Artsy



Arstyunitiscraftedwithhigh-qualityacrylic,offeringbothdurabilityandasleekdesign.Thisall-in-onesystemisengineeredforeasyinstallation,bringingtogetherallessentialfunctions—filtration,circulation,disinfection,drainage,andlighting—inasingle,compactunit.

Featuring a multifunctional jet, Arsty not only ensures efficient water circulation but also provides hydromassage capabilities, adding an extra element of enjoyment for swimmers. Ideal for children's pools, this versatile unit combines effective filtration with fun and relaxation, making pool maintenance simpler and more enjoyable.

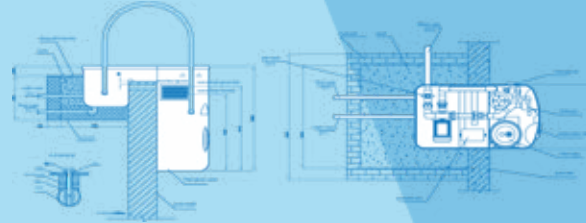

| CODE | PUMP | FLOW | FILTER RECISSION | FILTER AREA | NOISE | OUTLINE SIZE | PRICE |
|-----------|----------------|---------------------------|------------------|---------------------|---------|-----------------|-----------|
| 102.26.15 | 0,75 hp | 10 m ³ /h | < 5m | 0,26 m ² | ≤ 40 db | 1100X580X1080mm | 4300,00 € |
| 102.26.16 | 1,00 hp | 15 m ³ /h | < 5m | 0,26 m ² | ≤ 40 db | 1100X580X1080mm | 4500,00 € |
| 102.26.17 | 1,20 hp | 18 m ³ /h | < 5m | 0,26 m ² | ≤ 40 db | 1100X580X1080mm | 4750,00 € |
| 102.26.19 | 0,40 - 2,00 hp | 16 - 37 m ³ /h | < 5m | 0,26 m ² | ≤ 40 db | 1100X580X1080mm | 5500,00 € |
| 102.26.10 | 0,50 - 2,50 hp | 18 - 40 m ³ /h | < 5m | 0,26 m ² | ≤ 40 db | 1100X580X1080mm | 5650,00 € |

ROCK



The ROCK Series pump room is a compact, ready-to-install solution made from high-durability fibreglass, offering excellent resistance to moisture and outdoor conditions.

It comes fully equipped with a sand filter and multiport valve, pump, and all necessary plumbing and valves, professionally assembled for reliable performance. The layout can be adapted to your pool configuration and can be pre-equipped with electrical boards and water treatment systems such as salt chlorinators, UV units, and dosing pumps.

| CODE | DESCRIPTION | FLOW | SIZE | PRICE |
|------------|------------------|-------------------------|--------------------|----------|
| 104.26.20 | Ø400-450, 0,50hp | 8-10 m ³ /h | 1,32 X 1,34 X 0,98 | 3184,86€ |
| 104.26.21 | Ø500-550, 0,75hp | 10-12 m ³ /h | 1,32 X 1,34 X 0,98 | 3329,80€ |
| 104.26.22 | Ø600-650, 1,00hp | 12-15 m ³ /h | 1,32 X 1,34 X 0,98 | 3800,83€ |
| 104.26.26 | EMPTY | - | 1,32 X 1,34 X 0,98 | 1989,18€ |
| 104.26.26N | EMPTY | - | 1,55 X 1,56 X 1,37 | 2287,55€ |

FOREST



The FOREST Series pump room is a practical, ready-to-install solution designed for reliable pool equipment housing. The body is manufactured from durable plastic, while the lid is made from high-strength fibreglass, ensuring resistance to outdoor conditions and easy access for maintenance.

It comes fully equipped with a sand filter and multiport valve, pump, and all necessary plumbing and valves, professionally assembled for efficient operation. The system can be adjusted to your pool configuration and can be pre-equipped with electrical boards and water treatment systems, including salt chlorinators, UV systems, and dosing pumps.

| CODE | DESCRIPTION | FLOW | SIZE | PRICE |
|------------|------------------|-------------------------|--------------------|----------|
| 104.26.00 | Ø400-450, 0,50hp | 8-10 m ³ /h | 1,18 X 1,18 X 0,93 | 3007,32€ |
| 104.26.01 | Ø500-535, 0,75hp | 10-12 m ³ /h | 1,18 X 1,18 X 0,93 | 3094,28€ |
| 104.26.02 | Ø600-650, 1,00hp | 12-22 m ³ /h | 1,18 X 1,18 X 0,93 | 3510,97€ |
| 104.26.03 | Ø700-760, 1,50hp | 22-26 m ³ /h | 1,18 X 1,18 X 0,93 | 4257,36€ |
| 102.01.114 | EMPTY | - | 1,10 X 1,27 X 0,93 | 1480,69€ |
| 104.26.04 | EMPTY | - | 1,18 X 1,18 X 0,93 | 1644,97€ |



OXYGON⁺

Lights - Φωτισμός

Resin LED Light



The Oxygon Underwater Resin LED Light features a sleek, flat design with a fully resin-encapsulated LED board, ensuring excellent durability and reliable waterproof protection for long-term underwater use.

Available in 12W or 24W, and operating at 12V AC, it delivers efficient and consistent illumination. Supplied with a 2.5-meter connection cable, the light allows for quick and easy installation in new or renovated swimming pools.

A modern, dependable lighting solution for enhanced pool aesthetics and safety.

| CODE | DESCRIPTION | WATT | PRICE |
|-----------|---|---------|----------|
| 105.01.32 | Plastic flat resin underwater LED light cool white | 12w/12v | 291,99 € |
| 105.01.33 | Plastic flat resin underwater LED light RGB 9 modes | 12w/12v | 309,55 € |
| 105.01.34 | Plastic flat resin underwater LED light cool white | 18w/12v | 344,74 € |
| 105.01.35 | Plastic flat resin underwater LED light RGB 9 modes | 18w/12v | 365,84 € |
| 105.01.36 | Plastic flat resin underwater LED light cool white | 24w/12v | 401,03 € |
| 105.01.37 | Plastic flat resin underwater LED light RGB 9 modes | 24w/12v | 436,19 € |

2140lm at 18w Luminux LED light



The LUMINUX Series flat wall light combines elegant design with an ultra-thin profile, delivering a modern and discreet look inside the swimming pool. With an outstanding 2140 lumens at just 18W, it stands out as one of the brightest and most efficient underwater lights on the market.

Designed for performance and simplicity, the LUMINUX Series offers powerful, uniform illumination while ensuring quick and convenient wall-mounted installation, making it an ideal choice for both new pools and renovations.

High brightness, refined aesthetics, and effortless installation—LUMINUX redefines underwater lighting.

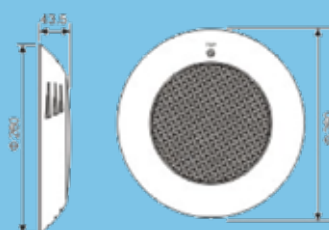

| CODE | DESCRIPTION | WATT | PRICE |
|-----------|---|---------|----------|
| 105.01.60 | Luminux LED light COOL white, 2137lm, 162leds | 18w/12v | 348,27 € |
| 105.01.61 | Luminux LED light RGB, 924lm, 162leds | 18w/12v | 369,37 € |

Flat LED Light



The FLAT Series underwater LED light offers a modern, discreet design with wall-mounted installation, ideal for both new pools and renovations. Designed for reliable underwater performance, it provides uniform illumination and enhances the pool's visual appeal.

Available in 12W and 24W versions (12V AC), the FLAT Series is supplied with a 2.5 m connection cable for easy and secure installation. Its slim, flat profile ensures a clean finish while delivering efficient and long-lasting lighting.

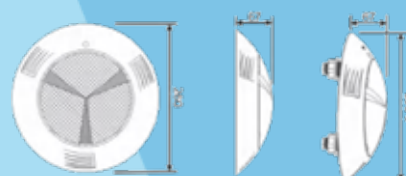

| CODE | DESCRIPTION | WATT | PRICE |
|-----------|---|---------|----------|
| 105.01.38 | Plastic Flat underwater LED light cool white | 18w/12v | 235,69 € |
| 105.01.39 | Plastic Flat underwater LED light RGB 9 modes | 18w/12v | 270,85 € |
| 105.01.40 | Plastic Flat underwater LED light, cool white | 24w/12v | 270,85 € |
| 105.01.41 | Plastic Flat underwater LED light RGB 9 modes | 24w/12v | 309,55 € |

Ultra Thin Spot LED Light



The Ultra Thin Series underwater light features a sleek, minimalist design that integrates seamlessly with the pool wall, preserving clean lines and modern aesthetics.

Designed for quick and easy installation, it is simply inserted into a 3/4" pipe or Ø50 inlet, making it ideal for both new constructions and renovations. Suitable for all types of swimming pools, the Ultra Thin Series combines discreet appearance with reliable performance for elegant underwater illumination.

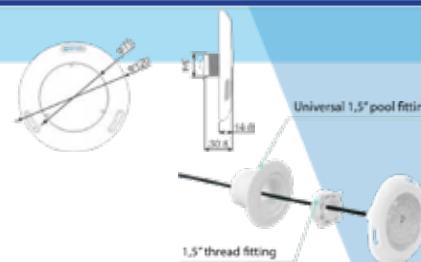

| CODE | DESCRIPTION | WATT | PRICE |
|------------|--------------------------------|--------|----------|
| 105.01.84 | Ultra Thin LED Spot cool white | 6w/12v | 192,25 € |
| 105.01.84C | Ultra Thin LED Spot RGB | 6w/12v | 212,25 € |
| | Ultra Thin LED Spot cool white | 9w/12v | 221,08 € |
| | Ultra Thin LED Spot RGB | 9w/12v | 244,08 € |

Niche LED Light



Durable and stylish, the NICHE Series underwater LED light is manufactured from high-quality ABS and is perfectly suited for steel panel pools with liner finishes. Designed for reliability and long service life, it provides powerful, vibrant illumination while maintaining low energy consumption.

Easy to install, the NICHE Series is ideal for both new pool constructions and renovation projects, offering a simple upgrade that enhances safety, atmosphere, and visual appeal.

A smart lighting solution that combines efficiency, durability, and modern pool aesthetics.

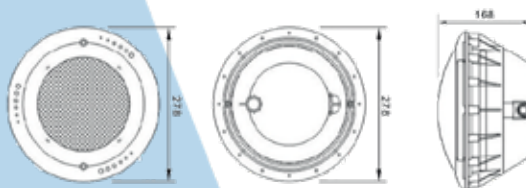

| CODE | DESCRIPTION | WATT | PRICE |
|-----------|---|---------|----------|
| 105.01.42 | Plastic underwater LED light Par 56, cool white plastic niche, concrete pools | 18w/12v | 214,59 € |
| 105.01.43 | Plastic underwater LED light Par 56, RGB 9 modes, plastic niche, concrete pools | 18w/12v | 232,16 € |
| 105.01.44 | Plastic underwater LED light Par 56, cool white plastic niche, concrete pools | 24w/12v | 249,76 € |
| 105.01.45 | Plastic underwater LED light Par 56, RGB 9 modes, plastic niche, concrete pools | 24w/12v | 267,36 € |
| 105.01.46 | Plastic underwater LED light Par 56, cool white plastic niche, liner pools | 18w/12v | 249,76 € |
| 105.01.47 | Plastic underwater LED light Par 56, cool RGB 9 modes, plastic niche, liner pools | 18w/12v | 267,36 € |
| 105.01.48 | Plastic underwater LED light Par 56, cool white plastic niche, liner pools | 24w/12v | 288,45 € |
| 105.01.49 | Plastic underwater LED light Par 56, cool RGB 9 modes, plastic niche, liner pools | 24w/12v | 306,04 € |

Panel/Liner Skiathos LED Light



The SKIATHOS Series underwater light is a reliable and elegant lighting solution for swimming pools and spas, designed in white ABS plastic to perfectly match pools with white equipment.

Available in daylight white or RGB, the RGB version offers 14 selectable lighting programs to create the desired atmosphere. The light is equipped with a 30W or 45W resin-sealed LED, providing powerful illumination while ensuring complete protection against water penetration.

With a 176 mm diameter and 30 mm thickness, the luminaire is supplied with a wall socket, 1 m hose, and 2.5 m cable for easy installation. Suitable for both concrete and liner pools, the SKIATHOS Series combines durability, safety, and visual appeal for long-lasting underwater lighting.

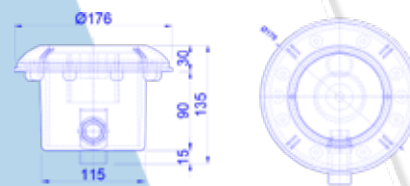

| CODE | DESCRIPTION | WATT | PRICE |
|-----------|---|---------|----------|
| 105.50.10 | Skiathos light AC12V Cool White, Concrete | 30w/12v | 321,38 € |
| 105.50.11 | Skiathos light AC12V RGB, Concrete | 45w/12v | 342,33 € |
| 105.50.12 | Skiathos light AC12V Cool White, Liner | 30w/12v | 426,12 € |
| 105.50.13 | Skiathos light AC12V RGB, Liner | 45w/12v | 447,06 € |

AISI316 LED wall Light

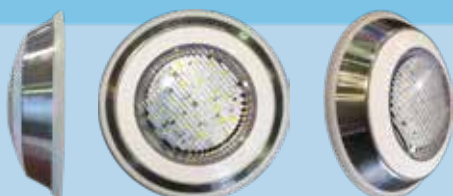

The AISI-316 Series underwater light is designed for concrete swimming pools and spas, offering durability and refined aesthetics. Manufactured from AISI-316 stainless steel, it features a specially designed faceplate that provides enhanced resistance to chemicals, ensuring long-lasting performance even in demanding pool environments.

Available in cool white and RGB, the AISI-316 Series combines reliable illumination with an elegant, contemporary design, enhancing the visual appeal of the pool while creating a cozy and inviting atmosphere both day and night.

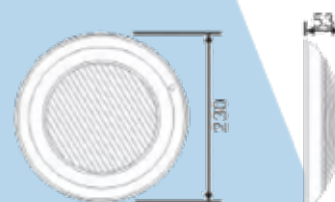

| CODE | DESCRIPTION | WATT | PRICE |
|-----------|------------------------------------|---------|----------|
| 105.01.79 | AISI316 LED wall light cool white | 12w/12v | 244,55 € |
| 105.01.80 | AISI316 LED wall light RGB 9 modes | 12w/12v | 298,85 € |

Concrete Spot LED Light

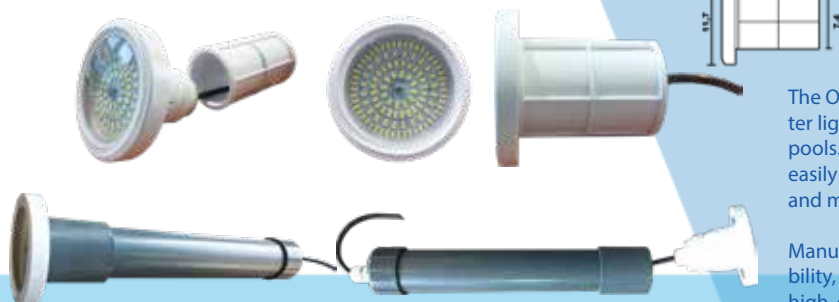

The Oxygon Concrete LED Light Series is a high-quality underwater lighting solution specifically designed for concrete swimming pools. Featuring a patented replacement system, the light can be easily serviced or replaced without draining the pool, saving time and maintenance costs.

Manufactured from premium materials, it offers excellent durability, long service life, and powerful, uniform illumination. With high energy efficiency and reliable performance, the Concrete LED Light Series enhances both pool safety and visual appeal.

| CODE | DESCRIPTION | WATT | PRICE |
|-----------|--|------------|----------|
| 105.01.53 | spot LED light COOL white, 450lm, 24leds | 6w/12v AC | 242,73 € |
| 105.01.54 | spot LED light COOL white, 450lm, 24leds | 9w/12v AC | 260,32 € |
| 105.01.55 | spot LED light COOL white, 450lm, 24leds | 12w/12v AC | 277,89 € |
| 105.01.56 | spot LED light RGB, 450lm, 24leds | 6w/12v AC | 260,32 € |
| 105.01.57 | spot LED light RGB, 450lm, 24leds | 9w/12v AC | 277,89 € |
| 105.01.58 | spot LED light RGB, 450lm, 24leds | 12w/12v AC | 295,48 € |
| 105.01.59 | PVC Niche with cable sealer | | 33,43 € |

Recessed Spot LED Light



The LIGHT Series recessed LED is an elegant underwater lighting solution for swimming pools and spas, designed with a white ABS body for a clean, modern finish. With a total diameter of 84 mm and an ultra-slim 11 mm faceplate thickness, it integrates discreetly into any pool design.

Installation is flexible, with options for 1.5" or 2" male thread or push-fit mounting into Ø63 PN10 pipe. The light is resistant to pool chemicals and UV exposure, ensuring long-lasting performance.

Available with 8W LED bulbs in warm white, cool white, neutral white, blue, or RGB, the LIGHT Series offers both functional illumination and ambient effects for enhanced pool aesthetics.



| CODE | DESCRIPTION | WATT | PRICE |
|-----------|-------------------------------|-----------|----------|
| 105.01.94 | Recessed Spot Cool White ABS | 8w/12v AC | 217,78 € |
| 105.01.95 | Recesse Spot RGB ABS | 8w/12v AC | 232,05 € |
| 105.01.96 | Recessed Spot Cool White INOX | 8w/12v AC | 260,63 € |
| 105.01.97 | Recesse Spot RGB INOX | 8w/12v AC | 274,90 € |

Par 56 LED Lamp



Upgrade your pool lighting with Oxygon's LIGHT Series PAR56 LED lamp, designed for high performance, energy efficiency, and long service life. It delivers bright, uniform underwater illumination while maintaining low power consumption, making it an ideal choice for modern pool installations.

The LIGHT Series is easy to install, fully compatible with standard PAR56 niches, and suitable for both new pools and retrofit projects. Available in white or RGB versions, it allows you to create elegant lighting or dynamic colour effects for an enhanced swimming experience.

| CODE | DESCRIPTION | WATT | PRICE |
|-----------|----------------------------|---------|---------|
| 105.13.35 | LED lamp PAR56 cool white | 18w/12v | 141.30€ |
| 105.13.36 | LED lamp PAR56 RGB 9 modes | 18w/12v | 177.55€ |
| 105.13.37 | LED lamp PAR56 cool white | 24w/12v | 177.55€ |
| 105.13.38 | LED lamp PAR56 RGB 9 modes | 24w/12v | 213.76€ |

Dimmable Par 56 RGB LED Lamp



Upgrade your pool lighting with Oxygon's LIGHT Series PAR56 Dimmable RGB LED lamp, designed to combine performance, efficiency, and atmosphere. Featuring energy-efficient LED technology, it delivers vibrant, customizable colours to enhance any swimming pool environment.

The lamp supports smooth dimming and is compatible with remote control systems, allowing easy adjustment of brightness and colour to create the perfect ambiance. With a long service life and reliable underwater performance, the LIGHT Series is an ideal solution for both residential and commercial pools.

| CODE | DESCRIPTION | WATT | PRICE |
|-----------|--|---------|----------|
| 105.13.34 | LED dimmable lamp PAR56 RGB with Cool white / Warm white function ALL in one | 18w/12v | 279,27 € |

RGB Controllers

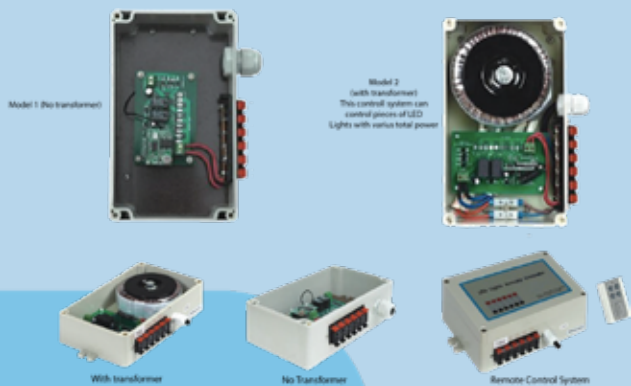

Oxygon's RGB LED controllers are designed to reliably power and control up to 6 swimming pool LED lights, delivering stable performance and vibrant colour effects. Available in two versions—with integrated transformer or without transformer—they offer maximum flexibility to suit different installation requirements.

Engineered for durability and safe operation in pool environments, Oxygon RGB controllers ensure efficient power management and smooth lighting control for both residential and commercial pools.

| CODE | DESCRIPTION | WATT | PRICE |
|-----------|--|------|-----------|
| 105.05.14 | Remote control system for LED lights with transformer | 100W | 503.65€ |
| 105.05.15 | Remote control system for LED lights with transformer | 150W | 598.71€ |
| 105.05.16 | Remote control system for LED lights with transformer | 300W | 1,034.87€ |
| 105.05.17 | Remote control system for LED lights without transformer | - | 318.84€ |

Controller for dimmable RGB Light



Take full control of your pool lighting with Oxygon's RGB dimmable light controllers. Easily adjust brightness, change colours, and create dynamic lighting effects to match any mood or occasion.

Designed for seamless integration with Oxygon LED lighting systems, these controllers offer smooth dimming, reliable performance, and energy-efficient operation, making them the perfect solution for enhancing your pool's atmosphere with style and precision.

| CODE | DESCRIPTION | WATT | PRICE |
|-----------|--|------|---------|
| 105.05.26 | Remote stepless controller for Dimmable LED lights Input AC 220V Output DC12V / 5A /60W | 60W | 543.15€ |

IP68 transformers



Designed for maximum safety and durability, Oxygon's IP68 closed-type transformers are the ideal solution for swimming pool installations. Fully sealed and waterproof, they ensure reliable performance even in high-humidity and demanding pump room environments.

Manufactured to the highest quality standards, these transformers provide safe, stable, and efficient power supply for underwater LED lighting and other pool equipment, guaranteeing long-term reliability and peace of mind.

| CODE | DESCRIPTION | WATT | PRICE |
|-----------|--|------|---------|
| 105.05.18 | Waterproof IP68 transformer output AC12V | 100 | 148.57€ |
| 105.05.19 | Waterproof IP68 transformer output AC12V | 150 | 163.06€ |
| 105.05.20 | Waterproof IP68 transformer output AC12V | 200 | 257.44€ |
| 105.05.21 | Waterproof IP68 transformer output AC12V | 300 | 304.34€ |
| 105.05.22 | Waterproof IP68 transformer output AC12V | 400 | 365.96€ |
| 105.05.23 | Waterproof IP68 transformer output AC12V | 600 | 713.78€ |

Connection BOX



Oxygon LED Light Series connection boxes are designed for safe, reliable, and easy electrical connections in swimming pool lighting installations. Manufactured from strong white ABS plastic, they offer excellent durability and resistance to pool environments.

Both versions allow easy and secure light cable connections. Each box features a square lid, four stainless steel screws, a special sealing O-ring integrated into the lid, and two cable connectors to ensure watertight performance. Upon request, the connection box can be supplied with an additional pair of cable connectors.

A compact and dependable solution for professional pool lighting installations.

| CODE | SPECIFICATONS | MATERIAL | HEIGHT | DIMENSION | PRICE |
|------------|---------------------|-----------|--------|-----------|--------|
| 104.01.04 | UV protection | white ABS | 60mm | 120 x 120 | 21.40€ |
| 104.01.041 | chemical resistance | white ABS | 100mm | 120 x 120 | 25.01€ |

IP65 Pool Control Electric Board CE



Oxygen electrical control boards are engineered to provide safe, reliable, and efficient control of swimming pool equipment. Built to high-quality manufacturing standards and fully CE certified, they ensure long-term performance and compliance with European safety regulations.

Each control board is supplied as standard with a main general switch, status indication lights, a safety switch, and a timer with relay for precise control of the filtration pump and pool lighting. Designed for ease of installation and operation, they offer a clean and organized electrical solution for any pool setup.

To meet the specific needs of each project, custom-made configurations are available on order, allowing integration of additional components and full adaptation to your pool equipment and system requirements.

A dependable and flexible solution for complete electrical pool management.

| CODE | DESCRIPTION | CURRENT | PRICE |
|-----------|---|---------|-----------|
| 105.21.10 | Single Phase for 1 pump | 220V | 525.02€ |
| 105.21.11 | Single Phase for 1 pump and lights control | 220V | 724.66€ |
| 105.21.12 | Single Phase for 2 pumps | 220V | 887.35€ |
| 105.21.13 | Single Phase for 2 pumps and lights control | 220V | 1,209.82€ |
| 105.21.14 | 3Phase for 1 pump | 380V | 724.66€ |
| 105.21.15 | 3Phase for 1 pump and lights control | 380V | 847.49€ |
| 105.21.16 | 3Phase for 2 pumps | 380V | 1,209.82€ |
| 105.21.17 | 3Phase for 2 pumps and lights control | 380V | 1,612.00€ |

Cable for Swimming pool lights



The Oxygen H07RN-F Pool Cable is a high-quality, heavy-duty flexible cable specially suited for swimming pool lighting and demanding installations. Featuring rubber insulation and a chloroprene (polychloroprene) rubber outer jacket, it offers excellent resistance to moisture, mechanical stress, and harsh environmental conditions.

With a voltage rating of 450/750 V, this harmonised cable is designed for reliable performance in industrial and pool environments, ensuring safety, durability, and long service life in critical applications.

| CODE | DESCRIPTION | DIMENSION | PRICE/meter |
|-----------|--|-----------|--------------|
| 105.27.50 | H07RN-F swimming pool lights cable in 50m roll | 2 X 2,5mm | upon request |



White Parts - - Λευκά Εξαρτήματα
ABS / INOX



OXYGON⁺



Floor Adjustable Base Inlet

Floor inlet made out of high quality ABS plastic. The top level is flat shaped for a better feeling in contact with a barefoot. The base can be adjusted up to 12 degrees inclination. Adjustable water flow, ideal for tiles or mosaic pools. ADJUSTABLE BASE

| CODE | DESCRIPTION | INSTALLATION | CONNECTION | PRICE |
|-----------|--|----------------|-------------------|--------|
| 104.07.33 | Floor inlet, flat top, adjustable base | mosaic / tiles | PVC PN10 Ø63 pipe | 18.13€ |

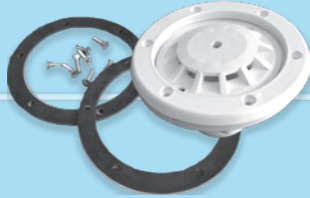

Floor Inlet For Liner

Floor inlet made out of high quality ABS plastic. The top level is flat shaped for a better feeling in contact with a barefoot. 2" male thread connection. With all the necessary parts to install at swimming pools with liner.

| CODE | DESCRIPTION | INSTALLATION | CONNECTION | PRICE |
|-----------|-----------------------|--------------|----------------|--------|
| 104.07.37 | Floor inlet, flat top | liner pools | 2" male thread | 37.64€ |

Liner Floor Return Inlets - Mixed ABS/AISI316



Injection moulded bottom inlets made of ABS or of ABS and stainless steel AISI-316. The top part of this inlet is flat shaped. Adjustable flow rate. Suitable for liner pools. Flow rate: 14 m³/h..

| CODE | DESCRIPTION | INSTALLATION | CONNECTION | PRICE |
|-----------|--------------------------------|--------------|------------|---------|
| 104.01.28 | Floor inlet, Mixed ABS-AISI316 | Liner | 2" thread | 131.13€ |

Adjustable Base Floor Return Inlet - Mixed ABS/AISI316



Injection moulded bottom inlets made of ABS or of ABS and stainless steel AISI-316. The top part of this inlet is flat shaped. Adjustable flow rate. Suitable for concrete pools. Oscillate base allowing up to 12° inlet adjustment. Flow rate: 14 m³/h..

| CODE | DESCRIPTION | INSTALLATION | CONNECTION | PRICE |
|-----------|---|----------------|------------|---------|
| 104.01.26 | Adjustable Floor inlet, Mixed ABS-AISI316 | mosaic / tiles | Ø 50 | 117.33€ |
| 104.01.27 | Adjustable Floor inlet, Mixed ABS-AISI316 | mosaic / tiles | Ø 63 | 117.33€ |

Floor Return Inlets - Mixed ABS/AISI316

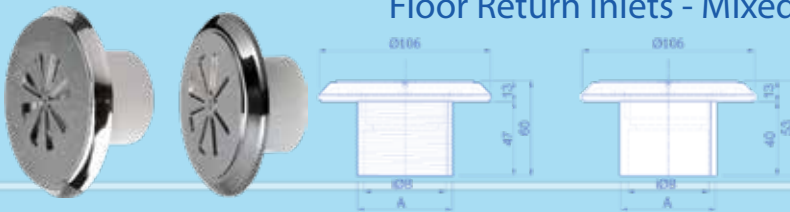

Injection moulded bottom inlets made of ABS or of ABS and stainless steel AISI-316. The top part of this inlet is flat shaped. Adjustable flow rate. Suitable for concrete pools. Flow rate: 14 m³/h..

| CODE | DESCRIPTION | INSTALLATION | CONNECTION | PRICE |
|-----------|------------------------------|----------------|------------|---------|
| 104.01.23 | Floor inlet, flat top, MIXED | mosaic / tiles | 2" thread | 117.33€ |
| 104.01.24 | Floor inlet, flat top, MIXED | mosaic / tiles | Ø63 | 117.33€ |
| 104.01.25 | Floor inlet, flat top, MIXED | mosaic / tiles | 2" sliped | 117.33€ |

Floor Inlets Full AISI316

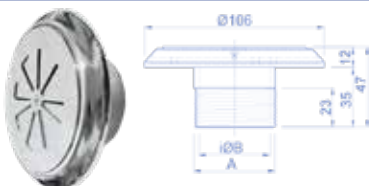

Injection moulded bottom inlets made of ABS or of ABS and stainless steel AISI-316. The top part of this inlet is flat shaped. Adjustable flow rate. Suitable for concrete pools. Flow rate: 14 m³/h..

| CODE | DESCRIPTION | INSTALLATION | CONNECTION | PRICE |
|-----------|--------------------------------|----------------|---------------|---------|
| 104.01.21 | Floor inlet, flat top, AISI316 | mosaic / tiles | 1 1/2" thread | 189.79€ |
| 104.01.22 | Floor inlet, flat top, AISI316 | mosaic / tiles | 2" thread | 203.60€ |



Wall Inlet

Wall inlet made out of high quality ABS plastic. Adjustable direction ball in several dimensions: 8, 12, 16, 20mm. Adjustable base up to 12 degrees inclination
ADJUSTABLE BASE

| CODE | DESCRIPTION | INSTALLATION | CONNECTION | PRICE |
|-----------|-----------------------------|----------------|-------------------|--------|
| 104.07.50 | Wall inlet, adjustable base | mosaic / tiles | PVC PN10 Ø63 pipe | 17.77€ |

Wall Inlet For Liner

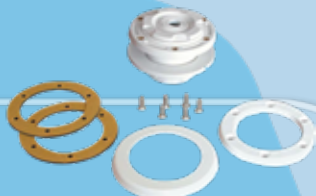

Wall inlet made out of high quality ABS plastic. Adjustable direction ball in several dimensions: 8, 12, 16, 20mm. " male thread connection. With all the nessecerary pars to install at swimming pools with liner.

| CODE | DESCRIPTION | INSTALLATION | CONNECTION | PRICE |
|-----------|----------------|--------------|----------------|--------|
| 104.07.72 | Wall inlet, 2" | liner pools | 2" male thread | 35.90€ |

Liner Wall Return Inlets - Mixed ABS/AISI316



Body made of highly resistant ABS material and face made of stainless steel AISI-316. Available eyeballs: STANDARD or SAFETY (EN-13451 compliant). Designed for liner swimming pools.

Flow rate:
 - Ø8: 1,5 m3/h
 - Ø12: 2,5 m3/h
 - Ø16: 3,5 m3/h
 - Ø20: 5,0 m3/h.

| CODE | DESCRIPTION | INSTALLATION | CONNECTION | PRICE |
|-----------|-------------------------------|--------------|------------|---------|
| 104.01.20 | Wall inlet, Mixed ABS-AISI316 | Liner | 2" thread | 124.21€ |

Wall Return Inlets - Mixed ABS/AISI316

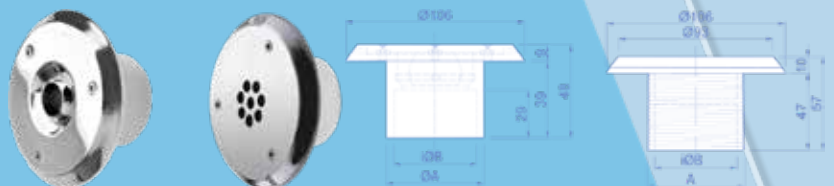

Body made of highly resistant ABS material and face made of stainless steel AISI-316. Available eyeballs: STANDARD or SAFETY (EN-13451 compliant). Designed for concrete swimming pools. Flow rate:

- Ø8: 1,5 m3/h
 - Ø12: 2,5 m3/h
 - Ø16: 3,5 m3/h
 - Ø20: 5,0 m3/h.

| CODE | DESCRIPTION | INSTALLATION | CONNECTION | PRICE |
|-----------|-------------------------------|----------------|------------|--------|
| 104.01.15 | Wall inlet, Mixed ABS-AISI316 | mosaic / tiles | Ø 63 | 93.18€ |
| 104.01.16 | Wall inlet, Mixed ABS-AISI316 | mosaic / tiles | 2" thread | 93.18€ |

Adjustable base Wall Return Inlet - Mixed ABS/AISI316

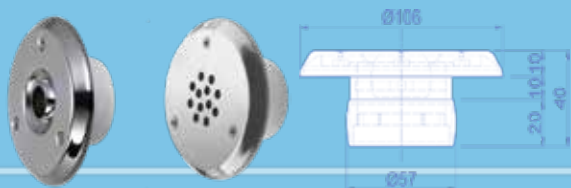

Body made of highly resistant ABS material and face made of stainless steel AISI-316. Available eyeballs: STANDARD or SAFETY (EN-13451 compliant). Designed for concrete swimming pools. Oscillate base allowing up to 12° inlet adjustment. Flow rate:

- Ø8: 1,5 m3/h
 - Ø12: 2,5 m3/h
 - Ø16: 3,5 m3/h
 - Ø20: 5,0 m3/h.

| CODE | DESCRIPTION | INSTALLATION | CONNECTION | PRICE |
|-----------|--|----------------|------------|---------|
| 104.01.18 | Adjustable Wall inlet, Mixed ABS-AISI316 | mosaic / tiles | Ø 50 | 127.67€ |
| 104.01.19 | Adjustable Wall inlet, Mixed ABS-AISI316 | mosaic / tiles | Ø 63 | 127.67€ |

Wall Return Inlets Full AISI316



Return inlets injection moulded made of ABS and stainless steel AISI-316. Two types eyeballs, STANDARD or SAFETY (compliant to EN-13451), directional in various orifices. Suitable for concrete pools. Flow rate:

- Inlet with 3 holes on top: 1,5 m3/h
 - Inlet with 5 holes on top: 2,5 m3/h
 - Inlet with 8 holes on top: 3,5 m3/h
 - Inlet with 12 holes on top: 5,0 m3/h..

| CODE | DESCRIPTION | INSTALLATION | CONNECTION | PRICE |
|-----------|-------------------------------|----------------|---------------|---------|
| 104.01.13 | Wall inlet, flat top, AISI316 | mosaic / tiles | 1 1/2" thread | 162.19€ |
| 104.01.14 | Wall inlet, flat top, AISI316 | mosaic / tiles | 2" thread | 179.46€ |

Wall TurboJet



Oxygon Wall TurboJet. Designed for powerful hydro-massage, this state-of-the-art system provides an invigorating and therapeutic experience, making it the perfect addition to any swimming pool

| CODE | DESCRIPTION | INSTALLATION | CONNECTION | PRICE |
|-----------|---------------|----------------|------------|--------|
| 104.24.35 | Wall TurboJet | Concrete pools | Ø63 | 91.25€ |

Wall Threaded Liner Inlet "Astro"

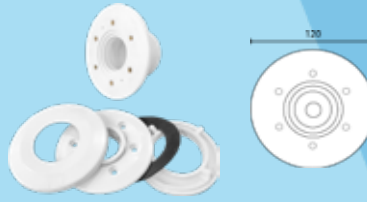

Wall inlet made out of high quality ABS plastic. Adjustable direction ball in several dimensions: 8, 12, 16, 20mm. " male thread connection. With all the nessecerary parts to install at swimming pools with liner.

| CODE | DESCRIPTION | INSTALLATION | CONNECTION | PRICE |
|-----------|-------------------------------|--------------|----------------|--------|
| 104.24.30 | Wall Liner Threaded inlet, 2" | liner pools | 2" male thread | 41.05€ |

Fiberglass Pools Wall Inlet

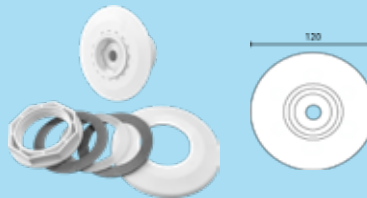

Wall inlet made out of high quality ABS plastic. Adjustable direction ball in several dimensions: 8, 12, 16, 20mm. " male thread connection. For fiberglass swimming pools installations.

| CODE | DESCRIPTION | INSTALLATION | CONNECTION | PRICE |
|-----------|---------------------------------|------------------|----------------|--------|
| 104.24.29 | Wall Liner Fiberglass inlet, 2" | Fiberglass pools | 2" male thread | 37.96€ |

Mini Wall Inlet Ø50



Wall inlet made out of high quality ABS plastic. Adjustable direction ball in 30mm dimension. Adjustable base up to 12 degrees inclination
ADJUSTABLE BASE

| CODE | DESCRIPTION | INSTALLATION | CONNECTION | PRICE |
|-----------|----------------------------------|----------------|-------------------|--------|
| 104.24.33 | Mini wall inlet, adjustable base | mosaic / tiles | PVC PN10 Ø50 pipe | 20.19€ |

Adjustable Vacuum Point

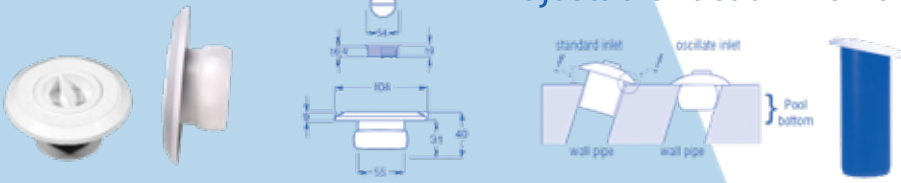

Vacuum point made out of high quality ABS plastic. Featuring a removable 1VT thread cap. The base can be adjusted up to 12 degrees inclination, ideal for tiles or mosaic pools.
ADJUSTABLE BASE

| CODE | DESCRIPTION | INSTALLATION | CONNECTION | PRICE |
|-----------|------------------------------|-------------------|--------------------|--------|
| 104.07.10 | Vacuum point, 1VT thread cap | tile/mosaic pools | PVC 10bar Ø63 pipe | 14.87€ |

Vacuum Point for Liner



Vacuum point made out of high quality ABS plastic. Featuring a removable 1VT thread cap. 2" male thread connection. Ideal for inner pools

| CODE | DESCRIPTION | INSTALLATION | CONNECTION | PRICE |
|-----------|------------------------------|--------------|----------------|--------|
| 104.07.12 | Vacuum point, 1VT thread cap | liner pools | 2" male thread | 29.72€ |

Vacuum Full AISI316



Complete structure made of durable AISI-316 stainless steel. Designed for concrete swimming pools.

| CODE | DESCRIPTION | INSTALLATION | CONNECTION | PRICE |
|-----------|----------------------|----------------|---------------|---------|
| 104.01.29 | Vacuum, Full AISI316 | mosaic / tiles | 1 1/2" thread | 169.07€ |
| 104.01.30 | Vacuum, Full AISI316 | mosaic / tiles | 2" thread | 179.46€ |

Vacuum Mixed ABS-AISI316

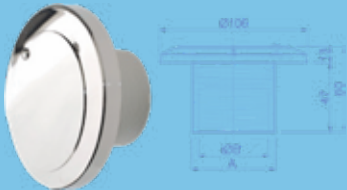

Body made of highly resistant ABS material and face made of stainless steel AISI-316 Designed for concrete swimming pools.

| CODE | DESCRIPTION | INSTALLATION | CONNECTION | PRICE |
|-----------|---------------------------|----------------|------------|---------|
| 104.01.31 | Vacuum, Mixed ABS-AISI316 | mosaic / tiles | 2" thread | 127.67€ |
| 104.01.32 | Vacuum, Mixed ABS-AISI316 | mosaic / tiles | Ø63 | 127.67€ |

Vacuum Mixed ABS-AISI316

Adjustable Base

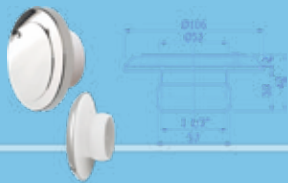

Injection moulded bottom inlets made of ABS or of ABS and stainless steel AISI-316. The top part of this inlet is flat shaped. Adjustable flow rate. Suitable for concrete pools. Oscillate base allowing up to 120 vacuum adjustment.

| CODE | DESCRIPTION | INSTALLATION | CONNECTION | PRICE |
|-----------|---------------------------|----------------|------------|---------|
| 104.01.33 | Vacuum, Mixed ABS-AISI316 | mosaic / tiles | 2" thread | 134.05€ |
| 104.01.34 | Vacuum, Mixed ABS-AISI316 | mosaic / tiles | Ø63 | 134.05€ |

Vacuum Mixed ABS-AISI316

For Liner



Body made of highly resistant ABS material and face made of stainless steel AISI-316 Designed for Liner swimming pools.

| CODE | DESCRIPTION | INSTALLATION | CONNECTION | PRICE |
|-----------|---------------------------|--------------|------------|---------|
| 104.01.35 | Vacuum, Mixed ABS-AISI316 | Liner | 2" thread | 127.67€ |

Compact Main Drain



Compact main drain made out of high quality ABS plastic available in two versions: one suitable for tile or mosaic pools and one for liner pools. A 2" female threaded connection is located on the side and another of Ø50 connection (sealed) is located on the bottom, giving the installer the choice in which to use.

| CODE | DIAMETER | INSTALLATION | CONNECTION | PRICE |
|-----------|----------|----------------|------------------|--------|
| 104.01.09 | 200 mm | mosaic / tiles | 2" thread or Ø50 | 26.57€ |
| 104.01.05 | 200 mm | liner | 2" thread or Ø50 | 36.05€ |

Anti-Vortex Main Drain



Made of high-quality ABS plastic, this compact main drain is designed exclusively for tile or mosaic pools. It features a 2" female threaded side connection and a sealed Ø50 bottom connection, offering flexible installation options. Engineered for safety and efficiency, it ensures optimal water circulation while preventing vortex formation.

| CODE | DESCRIPTION | INSTALLATION | CONNECTION | PRICE |
|-----------|------------------------------|----------------|------------------|--------|
| 104.06.37 | Anti-Vortex Main Drain | Concrete pools | 2" female thread | 39.85€ |
| 104.06.51 | Anti-Vortex Main Drain Cover | Mosaic Tiles | - | 34.85€ |

Premium Main Drain



Compact main drain made out of high quality ABS plastic available in two versions: one suitable for tile or mosaic pools and one for liner pools. A 2" female threaded connection is located on the side and another of Ø50 connection (sealed) is located on the bottom, giving the installer the choice in which to use.

| CODE | DIAMETER | INSTALLATION | CONNECTION | PRICE |
|-----------|----------|----------------|------------|--------|
| 104.07.96 | 200 mm | mosaic / tiles | 2" thread | 33.27€ |
| 104.07.09 | 200 mm | liner | 2" thread | 48.93€ |

Main Drain AISI316

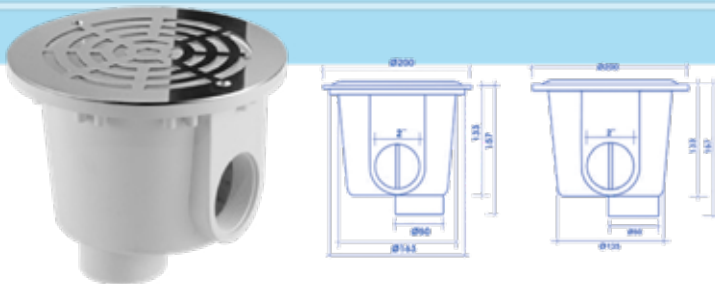

Drain grille made of white ABS material and stainless steel AISI-316. Liner guide that makes the flange's fixing easier. Double liner holes for easier replacement of the liner. Suitable for liner pools

| CODE | DIAMETER | INSTALLATION | CONNECTION | PRICE |
|-----------|----------|----------------|------------------|---------|
| 104.01.11 | 200 mm | mosaic / tiles | 2" thread or Ø50 | 127.67€ |
| 104.01.12 | 200 mm | liner | 2" thread or Ø50 | 148.38€ |

Concrete Main Drains

The main drains are available in a wide range of styles and sizes to satisfy any installation requirement of any tiled/mosaic residential or commercial swimming pool. These main drains are injection molded ABS plastic with high resistance to chemicals

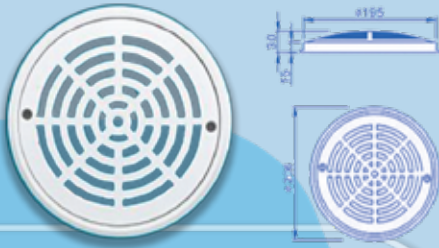

| | |
|-------------|------------------|
| CODE | 104.06.41 |
| DESCRIPTION | round main drain |
| COLOUR | white |
| MATERIAL | ABS |
| PRICE | 46.98€ |

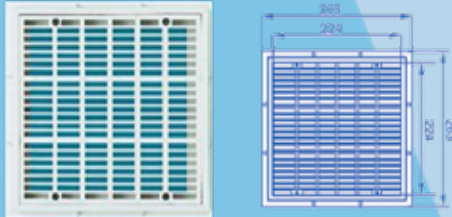

| | |
|-----------|-----------|
| CODE | 104.06.38 |
| SIZE | 263 x 263 |
| COLOUR | white |
| THICKNESS | 35 mm |
| PRICE | 51.43€ |

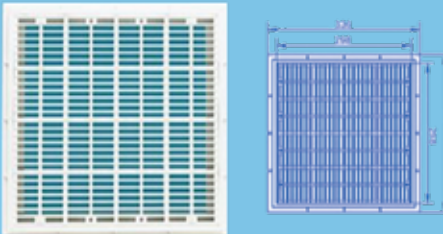

| | |
|-----------|-----------|
| CODE | 104.06.39 |
| SIZE | 336 x 336 |
| COLOUR | white |
| THICKNESS | 35 mm |
| PRICE | 68.69€ |

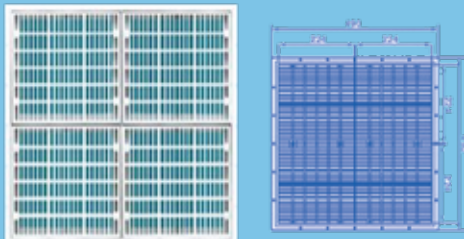

| | |
|-----------|-----------|
| CODE | 104.06.40 |
| SIZE | 490 x 490 |
| COLOUR | white |
| THICKNESS | 66 mm |
| PRICE | 206.72€ |

Stainless Steel Frames

Oxygon's stainless steel main drains are designed for durability and high performance in both residential and commercial tiled or mosaic swimming pools. Available in a wide range of sizes, they ensure optimal water circulation for any installation requirement. Made entirely of stainless steel, they offer exceptional resistance to chemicals, ensuring long-lasting reliability.

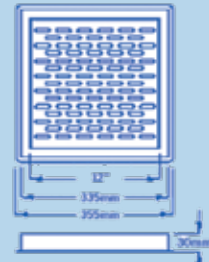
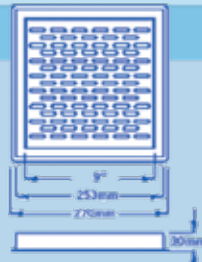

| CODE | DIMENSION | INSTALLATION | PRICE |
|------------|-------------------------------|--------------|---------|
| 104.06.360 | 9" (22,86cm) X 9" (22,86cm) | Concrete | 221.03€ |
| 104.06.361 | 12" (30,48cm) X 12" (30,48cm) | Concrete | 344.21€ |

Skimmers

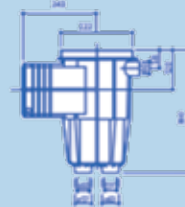

Skimmer Extension

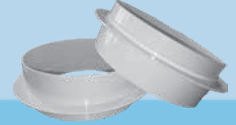

High-quality ABS skimmer, designed for efficient water circulation and debris removal. Ideal for both concrete (mosaic/tiles) and liner pools, ensuring durability and reliable performance.

| CODE | DESCRIPTION | INSTALLATION | PRICE |
|-------------|---------------------------|--------------|---------|
| 104.24.181 | Standard Concrete Skimmer | Concrete | 111.97€ |
| 104.24.184 | Standard Liner Skimmer | Liner | 119.23€ |
| 104.24.181A | Skimmer Extension | | 22.41€ |

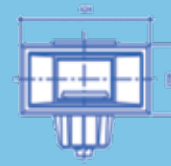
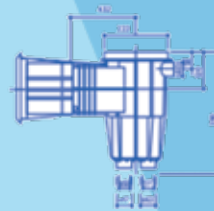

Skimmer Extension

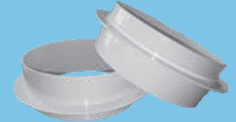

High-quality ABS Extended skimmer designed for optimal water circulation. Suitable for both concrete (mosaic/tiles) and liner pools. Durable, resistant to chemicals and UV exposure, ensuring long-lasting performance. Ideal for maintaining crystal-clear water.

| CODE | DESCRIPTION | INSTALLATION | PRICE |
|-------------|---------------------------|--------------|---------|
| 104.24.191 | Extended Concrete Skimmer | Concrete | 149.28€ |
| 104.24.194 | Extended Liner Skimmer | Liner | 169.94€ |
| 104.24.181A | Skimmer Extension | | 22.41€ |

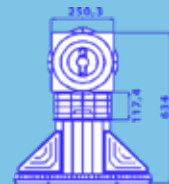
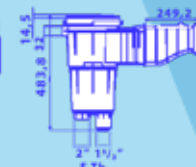
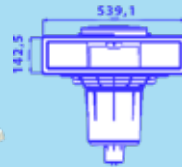
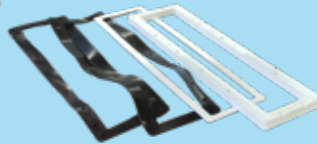

Made from high-quality ABS, the SlimLine skimmer ensures optimal water filtration and durability. Its sleek design makes it ideal for both concrete pools (mosaic/tiles) and liner pools, offering efficient surface water collection and seamless integration into any pool structure.

| CODE | DESCRIPTION | INSTALLATION | PRICE |
|------------|---------------------|--------------|---------|
| 104.24.195 | Slim Skimmer OXYGON | Liner | 290.64€ |
| 104.24.196 | Slim Skimmer OXYGON | Concrete | 264.56€ |

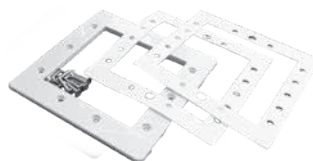

Premium SPA skimmer made of durable, high-quality ABS, designed for optimal water filtration. Ideal for both concrete (mosaic/tiles) SPAs and liner-coated SPAs. Ensures efficient debris collection and smooth water circulation for a pristine spa experience.

| CODE | DESCRIPTION | INSTALLATION | PRICE |
|-----------|-------------|------------------|---------|
| 104.24.69 | Spa skimmer | Concrete / Liner | 108.71€ |

Single Spine Grating

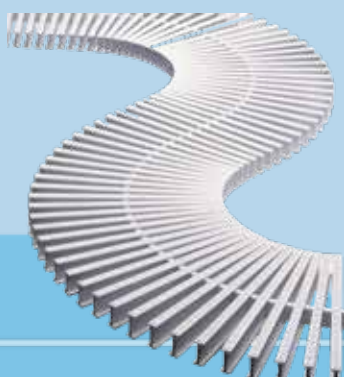

| CODE | DESCRIPTION | SHAPE | METERS / BOX* | PRICE / LIN. METER |
|-----------|-------------------|-----------|---------------|--------------------|
| 104.06.19 | 15cm Single Spine | I | 5 | 25.12€ |
| 104.06.20 | 20cm Single Spine | I | 5 | 32.72€ |
| 104.06.21 | 25cm Single Spine | I | 5 | 39.18€ |
| CODE | CUSTOM DIMENSION | HEIGHT mm | METERS / BOX* | PRICE / LIN METER |
| 104.06.31 | 110 mm - 140 mm | 24 | 5 | upon request |
| 104.06.32 | 141 mm -190 mm | 24 | 5 | upon request |
| 104.06.33 | 191 mm - 240 mm | 24 | 5 | upon request |
| 104.06.34 | 241 mm - 290 mm | 24 | 5 | upon request |
| 104.06.35 | 291 mm - 340 mm | 24 | 5 | upon request |
| 104.06.36 | 341 mm - 390 mm | 24 | 5 | upon request |

Durable and UV-resistant, this single spine drain grating is made from premium ABS, ensuring long-lasting performance in swimming pools. Designed for efficient water drainage and safety, it offers excellent resistance to chemicals and harsh pool environments. Perfect for both new installations and renovations.

Double Spine Grating

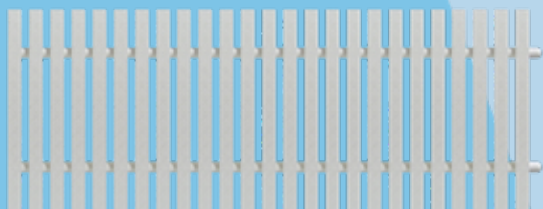

Durable and UV-resistant, this double spine drain grating is made from premium ABS, ensuring long-lasting performance in swimming pools. Designed for efficient water drainage and safety, it offers excellent resistance to chemicals and harsh pool environments. Perfect for both new installations and renovations.

| CODE | DESCRIPTION | SHAPE | METERS / BOX* | PRICE / LIN. METER |
|-----------|-------------------|-----------|---------------|--------------------|
| 104.06.22 | 20cm Double Spine | I | 5 | 41.31€ |
| 104.06.23 | 25cm Double Spine | I | 5 | 44.92€ |
| 104.06.24 | 30cm Double Spine | I | 5 | 48.55€ |
| CODE | CUSTOM DIMENSION | HEIGHT mm | METERS / BOX* | PRICE / LIN METER |
| 104.06.26 | 110 mm - 140 mm | 24 | 5 | upon request |
| 104.06.27 | 141 mm -190 mm | 24 | 5 | upon request |
| 104.06.28 | 191 mm - 240 mm | 24 | 5 | upon request |
| 104.06.29 | 241 mm - 290 mm | 24 | 5 | upon request |
| 104.06.30 | 291 mm - 340 mm | 24 | 5 | upon request |

Grating Corners



| CODE | CUSTOM DIMENSION | HEIGHT mm | METERS / BOX* | PRICE |
|-----------|---|-----------|---------------|--------|
| 104.06.46 | 90° Corner Grating | 145 | 0,10 | 65.20€ |
| 104.06.47 | 90° Corner Grating | 195 | 0,20 | 67.04€ |
| 104.06.48 | 90° Corner Grating | 245 | 0,45 | 72.46€ |
| 104.06.49 | 90° Corner Grating | 300 | 0,60 | 81.52€ |
| 104.06.42 | 45° Corner Grating | 145 | 0,10 | 65.23€ |
| 104.06.43 | 45° Corner Grating | 195 | 0,20 | 67.04€ |
| 104.06.44 | 45° Corner Grating | 245 | 0,45 | 72.46€ |
| 104.06.45 | 45° Corner Grating | 300 | 0,60 | 81.52€ |
| 104.06.25 | 24x26 Channel Corner 2m length piece | - | - | 10.88€ |

ACQ Acrylic Waterfall

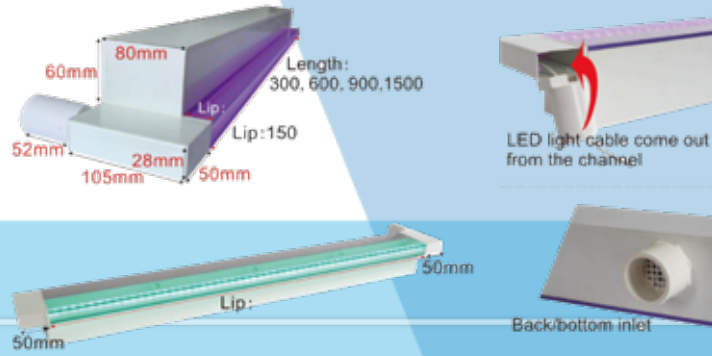

A stunning water feature that adds elegance and tranquility to any swimming pool. Made from high-quality acrylic, the ACQ waterfall creates a smooth, shimmering cascade of water, enhancing both aesthetics and relaxation. Designed for easy installation and durability, it's the perfect addition to modern pools.



| CODE | MODEL | INLETS | PRICE |
|-----------|----------------|--------|-----------|
| 430.50.11 | ACQ-300-L-RGB | 1 | 634.93€ |
| 430.50.12 | ACQ-600-L-RGB | 1 | 1,031.77€ |
| 430.50.13 | ACQ-900-L-RGB | 1 | 1,518.34€ |
| 430.50.23 | ACQ-1200-L-RGB | 1 | 1,831.95€ |
| 430.50.14 | ACQ-1500-L-RGB | 2 | 2,381.02€ |

Water Level Regulator



This product is designed to maintain precise in swimming pools, where proper water levels are required. It functions with the help of a floater that detects the level of water when that drops, so that the water surface remains at the desired level.

| CODE | DESCRIPTION | INSTALLATION | PRICE |
|-----------|--------------------|--------------|---------|
| 104.29.00 | Water Level Sensor | Concrete | 177.55€ |



OXYGON⁺

Stainless Steel - Ανοξείδωτα

Standard Ø42 Ladder



The Standard Ø42 Ladder is a high-quality stainless steel pool ladder designed for skimmer swimming pools. Available in both AISI304 and AISI316 stainless steel, this ladder offers durability and resistance to corrosion. It comes in various depths to suit different pool sizes, ensuring easy access and enhanced safety for swimmers. A perfect blend of functionality and sleek design, it's an essential addition to any pool setup.

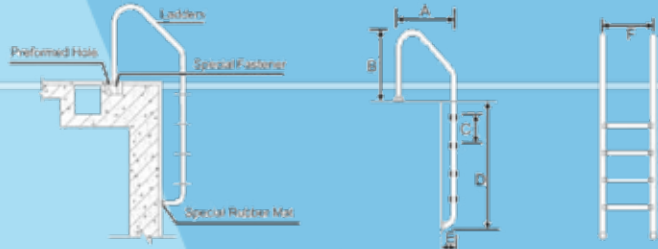

Ladder External Base Set

| CODE | STEPS | A (mm) | B (mm) | C (mm) | D (mm) | E (mm) | F (mm) | INOX | PRICE |
|------------|-------|--------|--------|--------|--------|--------|--------|------|---------|
| 104.09.124 | 2 | 645 | 720 | 250 | 580 | 170 | 500 | 304 | 365.96€ |
| 104.09.134 | 3 | 645 | 720 | 250 | 830 | 170 | 500 | | 387.69€ |
| 104.09.144 | 4 | 645 | 720 | 250 | 1080 | 170 | 500 | | 442.03€ |
| 104.09.154 | 5 | 645 | 720 | 250 | 1330 | 170 | 500 | | 485.52€ |
| 104.09.126 | 2 | 645 | 720 | 250 | 580 | 170 | 500 | 316 | 471.04€ |
| 104.09.136 | 3 | 645 | 720 | 250 | 830 | 170 | 500 | | 536.23€ |
| 104.09.146 | 4 | 645 | 720 | 250 | 1080 | 170 | 500 | | 608.73€ |
| 104.09.156 | 5 | 645 | 720 | 250 | 1330 | 170 | 500 | | 681.20€ |

Overflow Ø42 Ladder



The Overflow Ø42 Ladder is a high-quality stainless steel pool ladder designed specifically for swimming pools with an overflow channel. Made from durable AISI304 or AISI316 stainless steel, it offers exceptional resistance to corrosion and long-lasting performance. Available in various depths, this ladder ensures easy access and safety for pool users, while its sleek design enhances the overall aesthetic of the pool area. Ideal for both residential and commercial swimming pools, the Overflow Ø42 Ladder combines functionality and style.



Ladder External Base Set

| CODE | STEPS | A (mm) | B (mm) | C (mm) | E (mm) | F (mm) | H (mm) | W (mm) | INOX | PRICE |
|------------|-------|--------|--------|--------|--------|--------|--------|--------|------|---------|
| 104.09.424 | 2 | 957 | 710 | 250 | 200 | 208 | 1306 | 500 | 304 | 525.38€ |
| 104.09.434 | 3 | 957 | 710 | 250 | 200 | 208 | 1556 | 500 | | 579.73€ |
| 104.09.444 | 4 | 957 | 710 | 250 | 200 | 208 | 1806 | 500 | | 630.46€ |
| 104.09.454 | 5 | 957 | 710 | 250 | 200 | 208 | 2056 | 500 | | 710.16€ |
| 104.09.426 | 2 | 957 | 710 | 250 | 200 | 208 | 1306 | 500 | 316 | 673.92€ |
| 104.09.436 | 3 | 957 | 710 | 250 | 200 | 208 | 1556 | 500 | | 742.78€ |
| 104.09.446 | 4 | 957 | 710 | 250 | 200 | 208 | 1806 | 500 | | 807.99€ |
| 104.09.456 | 5 | 957 | 710 | 250 | 200 | 208 | 2056 | 500 | | 905.83€ |

MC series Ø42 Ladder

The MC Ø42 (MURO) stainless steel pool ladder combines elegance with functionality. Available in AISI304 and AISI316, this ladder is designed for swimming pools with narrow surroundings, offering a sleek, space-saving solution. Its stylish design and durable construction make it the perfect choice for modern pools, providing easy access while enhancing the overall aesthetic. Available in various depths to suit your needs.



Ladder External Base Set

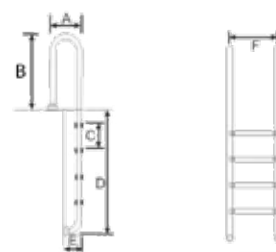
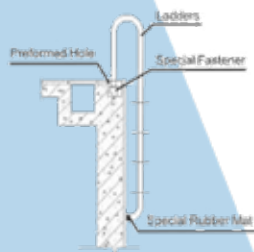

| CODE | STEPS | A (mm) | B (mm) | C (mm) | D (mm) | E (mm) | F (mm) | INOX | PRICE |
|------------|-------|--------|--------|--------|--------|--------|--------|------|---------|
| 104.09.224 | 2 | 360 | 630 | 250 | 680 | 170 | 500 | 304 | 365.96€ |
| 104.09.234 | 3 | 360 | 630 | 250 | 930 | 170 | 500 | | 387.69€ |
| 104.09.244 | 4 | 360 | 630 | 250 | 1180 | 170 | 500 | | 442.03€ |
| 104.09.254 | 5 | 360 | 630 | 250 | 1430 | 170 | 500 | | 485.52€ |
| 104.09.226 | 2 | 360 | 630 | 250 | 680 | 170 | 500 | 316 | 471.04€ |
| 104.09.236 | 3 | 360 | 630 | 250 | 930 | 170 | 500 | | 536.23€ |
| 104.09.246 | 4 | 360 | 630 | 250 | 1180 | 170 | 500 | | 608.73€ |
| 104.09.256 | 5 | 360 | 630 | 250 | 1430 | 170 | 500 | | 681.20€ |

SF series Ø42 Ladder

The SF Ø42 (SMART FIT) Ladder is a sleek and elegant stainless steel pool ladder, available in both AISI304 and AISI316 materials. Designed for pools with narrow surroundings, its smart fit design ensures a perfect installation in limited spaces. With various depth options, this ladder combines functionality with a stylish, modern look, providing both durability and a refined aesthetic to any pool.



Ladder External Base Set

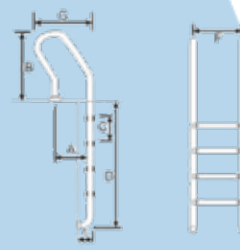
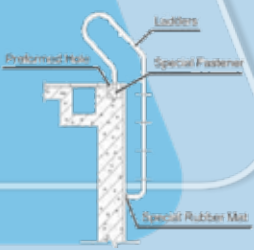

| CODE | STEPS | A (mm) | B (mm) | C (mm) | D (mm) | E (mm) | F (mm) | G (mm) | INOX | PRICE |
|------------|-------|--------|--------|--------|--------|--------|--------|--------|------|---------|
| 104.09.324 | 2 | 320 | 640 | 250 | 670 | 170 | 500 | 490 | 304 | 365.96€ |
| 104.09.334 | 3 | 320 | 640 | 250 | 920 | 170 | 500 | 490 | | 387.69€ |
| 104.09.344 | 4 | 320 | 640 | 250 | 1170 | 170 | 500 | 490 | | 442.03€ |
| 104.09.354 | 5 | 320 | 640 | 250 | 1420 | 170 | 500 | 490 | | 485.52€ |
| 104.09.326 | 2 | 320 | 640 | 250 | 670 | 170 | 500 | 490 | 316 | 471.04€ |
| 104.09.336 | 3 | 320 | 640 | 250 | 920 | 170 | 500 | 490 | | 536.23€ |
| 104.09.346 | 4 | 320 | 640 | 250 | 1170 | 170 | 500 | 490 | | 608.73€ |
| 104.09.356 | 5 | 320 | 640 | 250 | 1420 | 170 | 500 | 490 | | 681.20€ |

Dorian series Ø42 Ladder

Introducing the Dorian Ladder: a sleek, stainless steel pool ladder designed for modern swimming pools. Made from durable AISI316 steel, it features an elegant, minimalist design that suits pools without surrounding edges, as it requires only interior grip. Available in various depths, the Dorian Ladder combines style and functionality, offering easy access to your pool with a sophisticated touch. Perfect for those seeking both beauty and practicality.

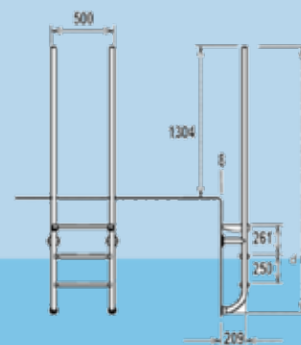

| CODE | STEPS | INOX | PRICE |
|-----------|-------|------|---------|
| 104.09.52 | 3 | 316 | 819.42€ |
| 104.09.53 | 4 | 316 | 888.93€ |

Grab Rail AISI304



The Extended Grab Rail AISI 304 is the ideal rail for safe and comfortable pool access. Made from high-quality stainless steel (AISI 304), it ensures durability and resistance to pool environments. Suitable for both private and public pools, it provides secure support at the pool edge.



| CODE | A (mm) | B (mm) | C (mm) | D (mm) | SPECIFICATION | PRICE |
|------------|--------|--------|--------|--------|---------------|---------|
| 104.09.006 | 1000 | 1250 | 880 | 230 | Ø42 | 692.30€ |

Antislip Ladder Steps



Upgrade your pool ladder with Oxygen's high-quality replacement steps. Designed for safety and durability, these steps feature an antislip surface for secure footing, even when wet. Made from corrosion-resistant materials, they ensure long-lasting performance in any pool environment. Easy to install and compatible with most standard ladders.

| CODE | DESCRIPTION | PRICE |
|-----------|-------------------------------|--------|
| 104.08.02 | Step for OXYGON SS304 ladders | 50.74€ |

Cobra Waterfalls



The COBRA Series stainless steel waterfalls combine elegant design with reliable performance, making them suitable for both residential and commercial swimming pools.

Manufactured from high-quality AISI-304 stainless steel, they offer excellent resistance to corrosion and long-term durability, while delivering a smooth, visually striking water flow that enhances any pool environment.

A refined water feature designed to add movement, sound, and a premium aesthetic to modern pool projects.

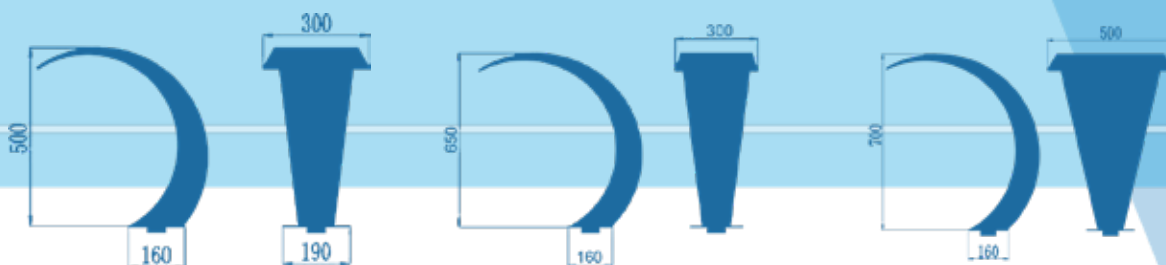

| CODE | DESCRIPTION | SUGGESTED PUMP | CONNECTION | PRICE |
|-----------|---|----------------|------------|-----------|
| 430.50.08 | Oxygen Waterfall Cobra Mini 50cmx30cm 304 | 1 hp | ø50 | 1,600.00€ |
| 430.50.07 | Oxygen Waterfall Cobra Midi 65cmx30cm 304 | 2 hp | ø63 | 2,500.00€ |
| 430.50.02 | Oxygen Waterfall Cobra Midi 70cmX50cm 304 | 2,5 hp | ø75 | 2,750.00€ |
| 430.50.09 | Oxygen Waterfall Cobra Mini 50cmx30cm 316 | 1 hp | ø50 | 2,100.00€ |
| 430.50.24 | Oxygen Waterfall Cobra Midi 65cmx30cm 316 | 2 hp | ø63 | 2,950.00€ |
| 430.50.25 | Oxygen Waterfall Cobra Midi 70cmX50cm 316 | 2,5 hp | ø75 | 3,350.00€ |

OXYGON⁺

Steel Panel Swimming pools



Oxygon Steel Panels

Strength, Speed & Versatility

At Oxygon, we have been perfecting the production of steel panels for swimming pools since 2001. Manufactured in Thessaloniki, our steel panels offer an innovative construction method that significantly enhances quality, speed, and cost-efficiency—similar to the principles of modern metal building structures

With over two decades of expertise, Oxygon has been at the forefront of prefabricated swimming pool technology. We design, manufacture, and distribute our steel panels exclusively in-house at our Thessaloniki facility. This allows us to offer both predefined designs and fully customized solutions tailored to your specific needs.

Experience the future of pool construction with Oxygon steel panel pools—efficient, durable, and built to last!



Why Choose Steel Panel Pools?

Steel panel pools provide numerous advantages over traditional concrete pools, thanks to the exceptional properties of steel and its strategic use in pool construction.

Lightweight & Strong – Steel panels are structurally durable while requiring minimal maintenance over time. One of their key benefits is their low weight—a steel panel pool can weigh up to 300% less than a similarly sized concrete pool. This makes them ideal for installations on higher floors, rooftops, balconies, and other elevated structures, often eliminating the need for major structural reinforcements.

Fast Installation – Steel panel pools can be installed 75% faster than traditional concrete pools. The panels are pre-manufactured at our facility according to your exact specifications and then assembled directly on-site, ensuring a precise and efficient installation.

Flexibility in Design – Thanks to steel's elasticity, these pools integrate seamlessly into surrounding structures, offering unparalleled design freedom. Whether for a private home, a hotel rooftop, or a high-rise spa, steel panel pools provide endless possibilities.

Extreme Durability – Steel is a material that retains its strength and integrity for decades. Unlike concrete pools, which are prone to cracking, steel panel pools can withstand seismic activity, ground movement, and extreme weather conditions without damage.

Sustainable & Eco-Friendly – Steel is one of the most recyclable materials in the world, making it an environmentally responsible choice for pool construction.

- Fully compliant with international and domestic technical standards
- Backed by a static study, ensuring seamless integration into planning permissions
- Available in heights from 0.30m to 2.50m
- No limitations in design or dimensions—customized to fit any project
- Easily adapted to accommodate skimmers, lighting, and other equipment

When properly maintained, a steel panel pool (whether spa or hot tub) has excellent corrosion resistance and also has a lasting aesthetic quality to it. The property of the steel panel to be extremely strong but at the same time light make it ideal for swimming pools and spas. This applies to both in-ground installations and installations at higher levels. This means you can have a metal panel pool installed at some level or even on the roof of your building or home, often without having to make any modifications to your main structural support.

Five different Available Steels

Oxygon's steel panels can be produced in 5 different steels to match every project needs

1. **Galvanized Steel Z275**
2. **Galvanized Steel Z275 with Aluminum Oxide Coating**
3. **Magnelis Galvanized Steel**
4. **Stainless Steel INOX441**
5. **Stainless Steel with PVC Coating**

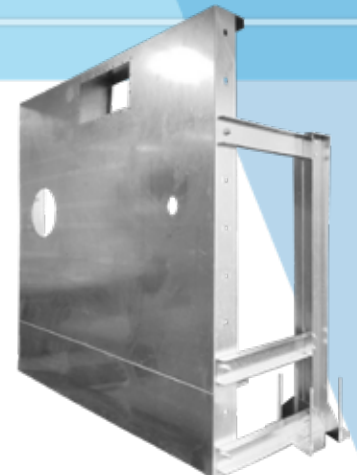

Oxygon Steel Panels

Precision, Strength & Innovation

The steel panels produced by Oxygon set the benchmark for manufacturing quality in Europe. Engineered and manufactured in Thessaloniki, Greece, they come with a static adequacy certification and are backed by a comprehensive static study, ensuring superior structural integrity and long-term performance.

Each panel features a 12 cm thickness, with a 2 mm thick steel sheet, providing exceptional strength and durability. Oxygon's panels are the only ones in Europe capable of independently supporting pool depths ranging from 0.60 meters to 2.5 meters, without requiring any modifications to the pool bottom. Additionally, they are the only panels in Europe designed to seamlessly adapt to sloping pool configurations, accommodating depth gradients with unmatched precision and stability.

With cutting-edge engineering and unparalleled flexibility, Oxygon's steel panels redefine the standards for custom pool constructi



At Oxygon, we specialize in manufacturing high-quality steel panels that can be custom-made in any shape, dimension, or depth to meet the most demanding architectural and structural requirements. With over 25 years of expertise, our advanced technical know-how guarantees precision, durability, and flawless execution.



Oxygon is the only company worldwide capable of producing self-supported steel panel swimming pools designed for major athletic competitions. Our innovative engineering ensures superior structural integrity, easy installation, and long-lasting performance, making our pools the top choice for professional sports facilities and international events.

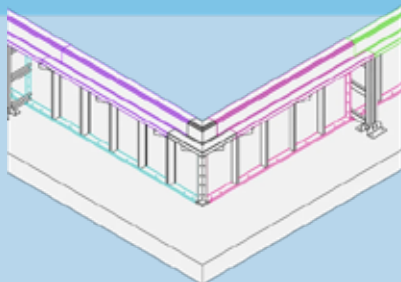

With uncompromising quality and cutting-edge technology, Oxygon sets the industry standard, delivering excellence in every project. When precision meets innovation, the result is simply perfection.

Steel Panel Complete swimming pool Kit 3m (W) X 4,5m (L)

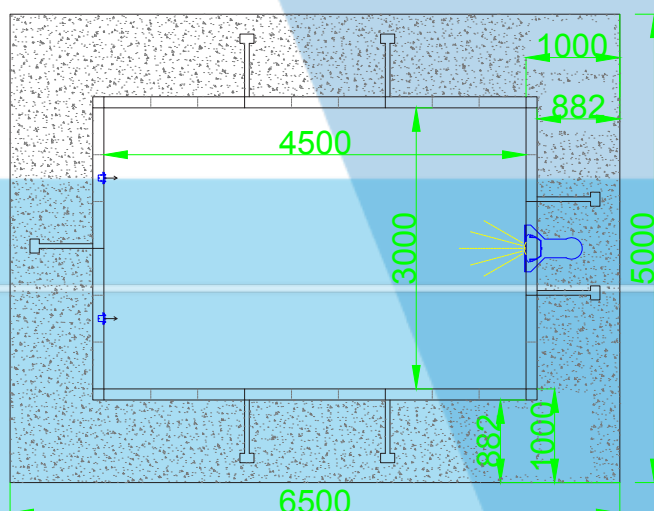

| | | |
|----------------------------|---|---|
| CODE | 104.31.36 | 104.31.38 |
| DEPTH | 1,20 m | 1,50 m |
| WATER VOLUME | 14,85 m ³ | 18,90 m ³ |
| RECIRCULATION RATE | 4 hours - 3,71 m ³ /h | 4 hours - 4,72 m ³ /h |
| RECOMMENDED RATE | 8,00 m ³ /h | 8,00 m ³ /h |
| PUMP | 0,5hp | 0,5hp |
| PUMP BASE | 1 Plastic | 1 Plastic |
| SAND FILTER | Ø450 | Ø450 |
| SAND | 75 kg | 75 kg |
| SKIMMERS | 1 Standard Liner | 1 Standard Liner |
| INLETS | 3 Wall Inlets Liner (1 is for the Water Regulator) | 3 Wall Inlets Liner (1 is for the Water Regulator) |
| MAIN DRAIN | 1 Compact Liner | 1 Compact Liner |
| LIGHTS | 1 Niche 18W/12V Cool White Liner | 1 Niche 18W/12V Cool White Liner |
| LIGHTING CABLE | 20 meters of H07RN-F | 20 meters of H07RN-F |
| ELECTRICAL PANEL | 1 Single phase for Pump and Lighting | 1 Single phase for Pump and Lighting |
| TRANSFORMER | 1 of 100W IP68 Closed type 220V/12V AC | 1 of 100W IP68 Closed type 220V/12V AC |
| WATER LEVEL REGULATOR | 1 item | 1 item |
| PVC MEMBRANE (LINER) | 1 Roll Premium Azzure Blue | 1 Roll Premium Azzure Blue |
| LIQUID PVC | 1 Azzure Blue | 1 Azzure Blue |
| STEEL PANELS | 1,2 m Height | 1,5 m Height |
| STAIR | INOX304, Standard 2 levels | INOX304, Standard 3 levels |
| PREFABRICATED PUMP ROOM | 1 Type Forest | 1 Type Forest |
| PVC ACCESSORIES | All Included | All Included |
| PIPING | All Included | All Included |
| ADHESIVE | 2 PVC Cement | 2 PVC Cement |
| COST OF MATERIALS* | 13,500.00€ * | 15,000.00€ * |
| *Conditions | *Prices do not include transportation and installation costs as well as VAT | |

Steel Panel Complete swimming pool Kit 3m (W) X 6,0m (L)

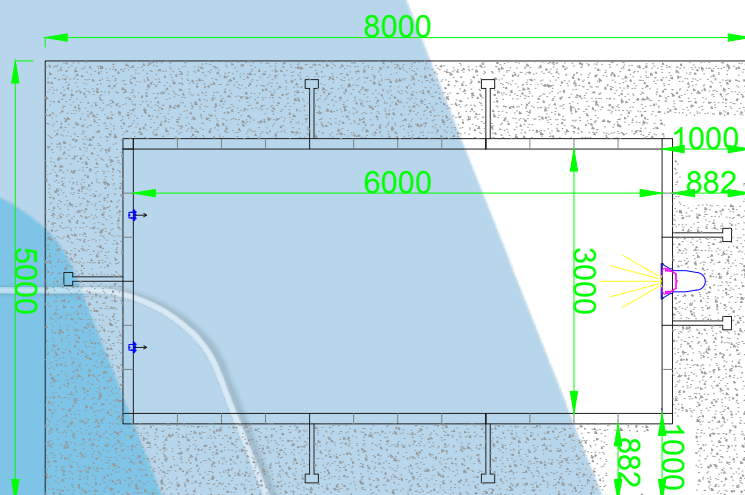

| | | |
|----------------------------|---|---|
| CODE | 104.31.40 | 104.31.42 |
| DEPTH | 1,20 m | 1,50 m |
| WATER VOLUME | 19,80 m ³ | 25,20 m ³ |
| RECIRCULATION RATE | 4 hours - 4,95 m ³ /h | 4 hours - 6,30 m ³ /h |
| RECOMMENDED RATE | 8,00 m ³ /h | 8,00 m ³ /h |
| PUMP | 0,5hp | 0,5hp |
| PUMP BASE | 1 Plastic | 1 Plastic |
| SAND FILTER | Ø450 | Ø450 |
| SAND | 75 kg | 75 kg |
| SKIMMERS | 1 Standard Liner | 1 Standard Liner |
| INLETS | 3 Wall Inlets Liner (1 is for the Water Regulator) | 3 Wall Inlets Liner (1 is for the Water Regulator) |
| MAIN DRAIN | 1 Compact Liner | 1 Compact Liner |
| LIGHTS | 1 Niche 18W/12V Cool White Liner | 1 Niche 18W/12V Cool White Liner |
| LIGHTING CABLE | 20 meters of H07RN-F | 20 meters of H07RN-F |
| ELECTRICAL PANEL | 1 Single phase for Pump and Lighting | 1 Single phase for Pump and Lighting |
| TRANSFORMER | 1 of 100W IP68 Closed type 220V/12V AC | 1 of 100W IP68 Closed type 220V/12V AC |
| WATER LEVEL REGULATOR | 1 item | 1 item |
| PVC MEMBRANE (LINER) | 2 Rolls Premium Azzure Blue | 2 Rolls Premium Azzure Blue |
| LIQUID PVC | 1 Azzure Blue | 1 Azzure Blue |
| STEEL PANELS | 1,2 m Height | 1,5 m Height |
| STAIR | INOX304, Standard 2 levels | INOX304, Standard 3 levels |
| PREFABRICATED PUMP ROOM | 1 Type Forest | 1 Type Forest |
| PVC ACCESSORIES | All Included | All Included |
| PIPING | All Included | All Included |
| ADHESIVE | 2 PVC Cement | 2 PVC Cement |
| COST OF MATERIALS* | 16,900.00€ * | 18,900.00€ * |
| *Conditions | *Prices do not include transportation and installation costs as well as VAT | |

Steel Panel Complete swimming pool Kit 3,5m (W) X 6,5m (L)

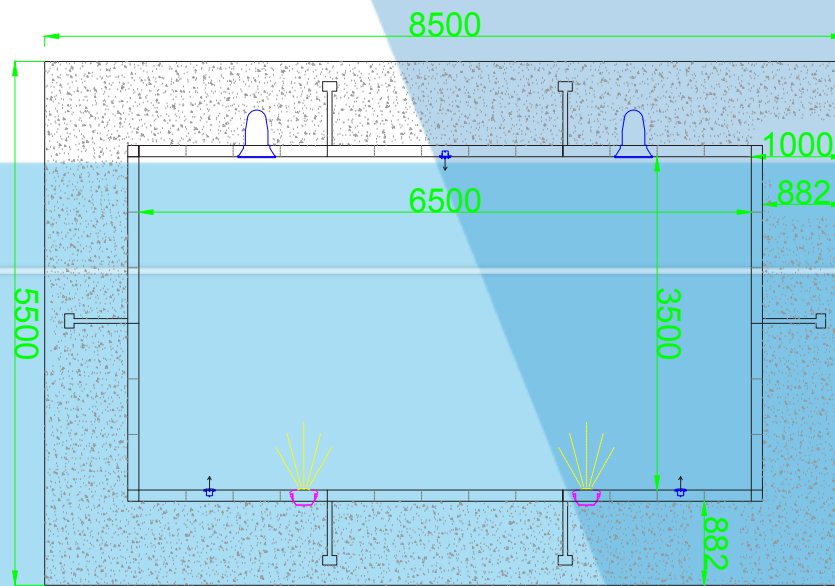

| | | |
|----------------------------|---|---|
| CODE | 104.31.44 | 104.31.46 |
| DEPTH | 1,20 m | 1,50 m |
| WATER VOLUME | 25,02 m ³ | 31,85 m ³ |
| RECIRCULATION RATE | 4 hours - 6,25 m ³ /h | 4 hours - 7,96 m ³ /h |
| RECOMMENDED RATE | 8,00 m ³ /h | 12,00 m ³ /h |
| PUMP | 0,5hp | 0,75hp |
| PUMP BASE | 1 Plastic | 1 Plastic |
| SAND FILTER | Ø450 | Ø535 |
| SAND | 75 kg | 100 kg |
| SKIMMERS | 2 Standard Liner | 2 Standard Liner |
| INLETS | 3 Wall Inlets Liner (1 is for the Water Regulator) | 3 Wall Inlets Liner (1 is for the Water Regulator) |
| MAIN DRAIN | 1 Compact Liner | 1 Compact Liner |
| LIGHTS | 2 Niche 18W/12V Cool White Liner | 2 Niche 18W/12V Cool White Liner |
| LIGHTING CABLE | 30 meters of H07RN-F | 30 meters of H07RN-F |
| ELECTRICAL PANEL | 1 Single phase for Pump and Lighting | 1 Single phase for Pump and Lighting |
| TRANSFORMER | 1 of 100W IP68 Closed type 220V/12V AC | 1 of 100W IP68 Closed type 220V/12V AC |
| WATER LEVEL REGULATOR | 1 item | 1 item |
| PVC MEMBRANE (LINER) | 2 Rolls Premium Azzure Blue | 2 Rolls Premium Azzure Blue |
| LIQUID PVC | 1 Azzure Blue | 1 Azzure Blue |
| STEEL PANELS | 1,2 m Height | 1,5 m Height |
| STAIR | INOX304, Standard 2 levels | INOX304, Standard 3 levels |
| PREFABRICATED PUMP ROOM | 1 Type Forest | 1 Type Forest |
| PVC ACCESSORIES | All Included | All Included |
| PIPING | All Included | All Included |
| ADHESIVE | 2 PVC Cement | 2 PVC Cement |
| COST OF MATERIALS* | 17,500.00€ * | 19,500.00€ * |
| *Conditions | *Prices do not include transportation and installation costs as well as VAT | |

Steel Panel Complete swimming pool Kit 4m (W) X 6m (L)

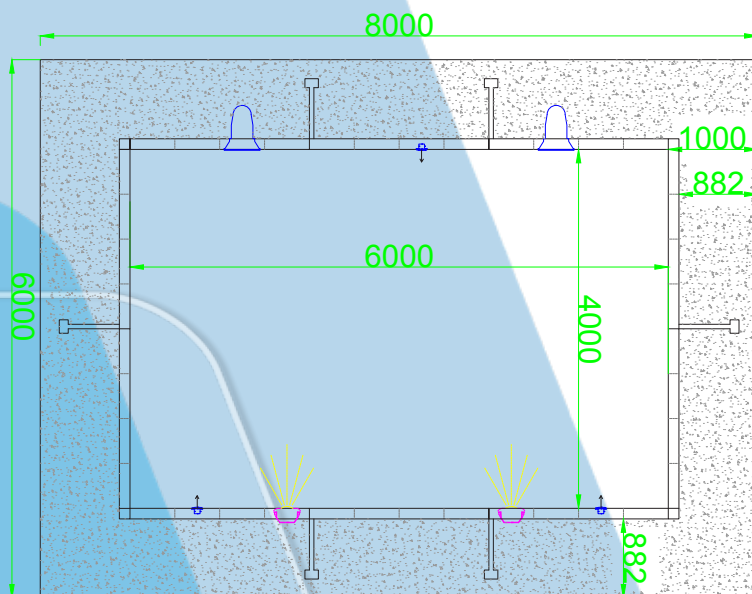

| | | |
|----------------------------|---|---|
| CODE | 104.31.48 | 104.31.50 |
| DEPTH | 1,20 m | 1,50 m |
| WATER VOLUME | 26,40 m ³ | 33,60 m ³ |
| RECIRCULATION RATE | 4 hours - 6,60 m ³ /h | 4 hours - 8,40 m ³ /h |
| RECOMMENDED RATE | 8,00 m ³ /h | 12,00 m ³ /h |
| PUMP | 0,5hp | 0,75hp |
| PUMP BASE | 1 Plastic | 1 Plastic |
| SAND FILTER | Ø450 | Ø535 |
| SAND | 75 kg | 100 kg |
| SKIMMERS | 2 Standard Liner | 2 Standard Liner |
| INLETS | 4 Wall Inlets Liner (1 is for the Water Regulator) | 4 Wall Inlets Liner (1 is for the Water Regulator) |
| MAIN DRAIN | 1 Compact Liner | 1 Compact Liner |
| LIGHTS | 2 Niche 18W/12V Cool White Liner | 2 Niche 18W/12V Cool White Liner |
| LIGHTING CABLE | 30 meters of H07RN-F | 30 meters of H07RN-F |
| ELECTRICAL PANEL | 1 Single phase for Pump and Lighting | 1 Single phase for Pump and Lighting |
| TRANSFORMER | 1 of 100W IP68 Closed type 220V/12V AC | 1 of 100W IP68 Closed type 220V/12V AC |
| WATER LEVEL REGULATOR | 1 item | 1 item |
| PVC MEMBRANE (LINER) | 2 Rolls Premium Azzure Blue | 2 Rolls Premium Azzure Blue |
| LIQUID PVC | 1 Azzure Blue | 1 Azzure Blue |
| STEEL PANELS | 1,2 m Height | 1,5 m Height |
| STAIR | INOX304, Standard 2 levels | INOX304, Standard 3 levels |
| PREFABRICATED PUMP ROOM | 1 Type Forest | 1 Type Forest |
| PVC ACCESSORIES | All Included | All Included |
| PIPING | All Included | All Included |
| ADHESIVE | 2 PVC Cement | 2 PVC Cement |
| COST OF MATERIALS* | 18,200.00€ * | 20,250.00€ * |
| *Conditions | *Prices do not include transportation and installation costs as well as VAT | |

Steel Panel Complete swimming pool Kit 4m (W) X 8m (L)

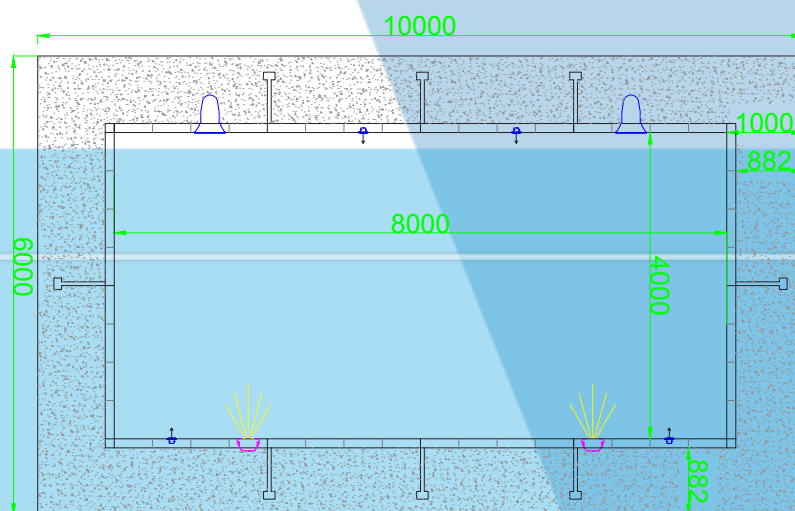

| | | |
|----------------------------|---|---|
| CODE | 104.31.52 | 104.31.54 |
| DEPTH | 1,20 m | 1,50 m |
| WATER VOLUME | 35,20 m ³ | 44,80 m ³ |
| RECIRCULATION RATE | 4 hours - 8,80 m ³ /h | 4 hours - 11,20 m ³ /h |
| RECOMMENDED RATE | 12,00 m ³ /h | 15,00 m ³ /h |
| PUMP | 0,75hp | 1,00hp |
| PUMP BASE | 1 Plastic | 1 Plastic |
| SAND FILTER | Ø535 | Ø635 |
| SAND | 100 kg | 175 kg |
| SKIMMERS | 2 Extended Liner | 2 Extended Liner |
| INLETS | 5 Wall Inlets Liner (1 is for the Water Regulator) | 5 Wall Inlets Liner (1 is for the Water Regulator) |
| MAIN DRAIN | 1 Compact Liner | 1 Compact Liner |
| LIGHTS | 2 Niche 18W/12V Cool White Liner | 2 Niche 18W/12V Cool White Liner |
| LIGHTING CABLE | 40 meters of H07RN-F | 40 meters of H07RN-F |
| ELECTRICAL PANEL | 1 Single phase for Pump and Lighting | 1 Single phase for Pump and Lighting |
| TRANSFORMER | 1 of 100W IP68 Closed type 220V/12V AC | 1 of 100W IP68 Closed type 220V/12V AC |
| WATER LEVEL REGULATOR | 1 item | 1 item |
| PVC MEMBRANE (LINER) | 2 Rolls Premium Azzure Blue | 2 Rolls Premium Azzure Blue |
| LIQUID PVC | 1 Azzure Blue | 1 Azzure Blue |
| STEEL PANELS | 1,2 m Height | 1,5 m Height |
| STAIR | INOX304, Standard 2 levels | INOX304, Standard 3 levels |
| PREFABRICATED PUMP ROOM | 1 Type Forest | 1 Type Forest |
| PVC ACCESSORIES | All Included | All Included |
| PIPING | All Included | All Included |
| ADHESIVE | 3 PVC Cement | 3 PVC Cement |
| COST OF MATERIALS* | 19,900.00€ * | 21,900.00€ * |
| *Conditions | *Prices do not include transportation and installation costs as well as VAT | |

Steel Panel Complete swimming pool Kit 4m (W) X 10m (L)

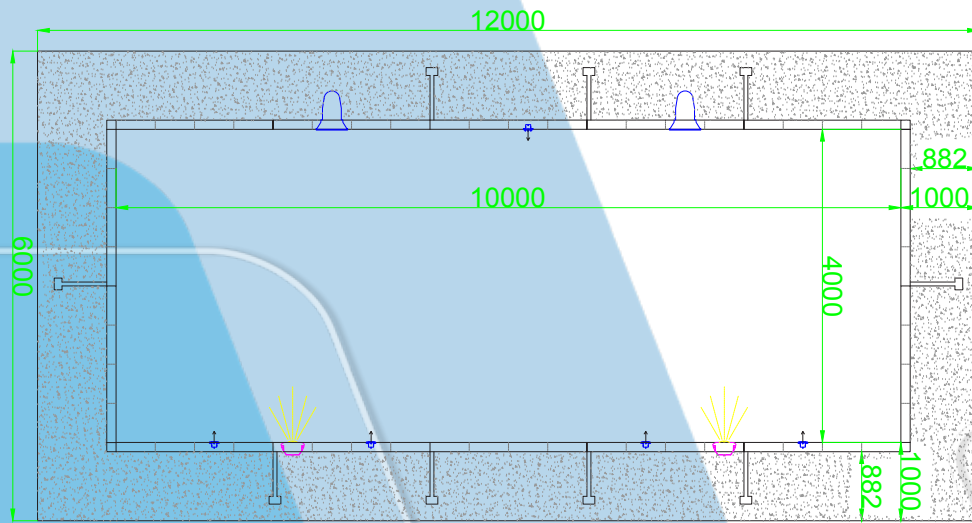

| | | |
|----------------------------|---|---|
| CODE | 104.31.56 | 104.31.58 |
| DEPTH | 1,20 m | 1,50 m |
| WATER VOLUME | 44,00 m ³ | 56,00 m ³ |
| RECIRCULATION RATE | 4 hours - 8,80 m ³ /h | 4 hours - 11,20 m ³ /h |
| RECOMMENDED RATE | 12,00 m ³ /h | 18,00 m ³ /h |
| PUMP | 0,75hp | 1,20hp |
| PUMP BASE | 1 Plastic | 1 Plastic |
| SAND FILTER | Ø535 | Ø635 |
| SAND | 100 kg | 175 kg |
| SKIMMERS | 2 Extended Liner | 2 Extended Liner |
| INLETS | 5 Wall Inlets Liner (1 is for the Water Regulator) | 5 Wall Inlets Liner (1 is for the Water Regulator) |
| MAIN DRAIN | 1 Compact Liner | 1 Compact Liner |
| LIGHTS | 2 Niche 18W/12V Cool White Liner | 2 Niche 18W/12V Cool White Liner |
| LIGHTING CABLE | 40 meters of H07RN-F | 40 meters of H07RN-F |
| ELECTRICAL PANEL | 1 Single phase for Pump and Lighting | 1 Single phase for Pump and Lighting |
| TRANSFORMER | 1 of 100W IP68 Closed type 220V/12V AC | 1 of 100W IP68 Closed type 220V/12V AC |
| WATER LEVEL REGULATOR | 1 item | 1 item |
| PVC MEMBRANE (LINER) | 3 Rolls Premium Azzure Blue | 3 Rolls Premium Azzure Blue |
| LIQUID PVC | 1 Azzure Blue | 1 Azzure Blue |
| STEEL PANELS | 1,2 m Height | 1,5 m Height |
| STAIR | INOX304, Standard 2 levels | INOX304, Standard 3 levels |
| PREFABRICATED PUMP ROOM | 1 Type Forest | 1 Type Forest |
| PVC ACCESSORIES | All Included | All Included |
| PIPING | All Included | All Included |
| ADHESIVE | 3 PVC Cement | 3 PVC Cement |
| COST OF MATERIALS* | 22,500.00 € * | 25,900.00 € * |
| *Conditions | *Prices do not include transportation and installation costs as well as VAT | |

Steel Panel Complete swimming pool Kit 4,8m (W) X 10,0m (L)

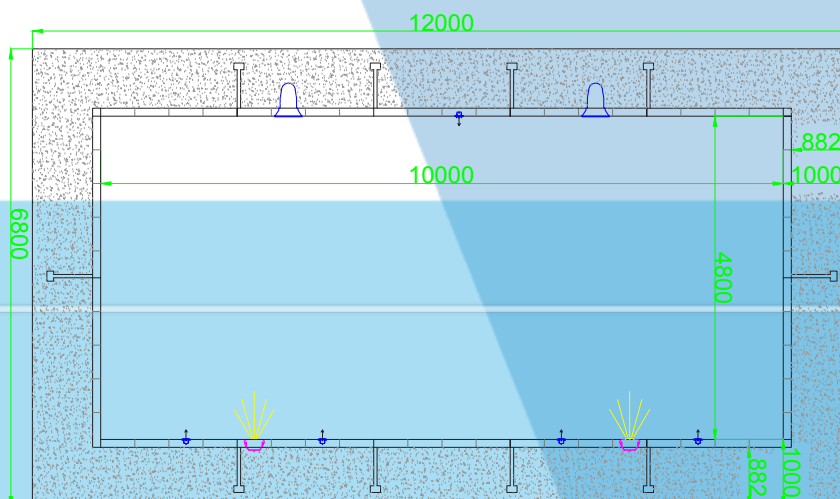

| | | |
|----------------------------|---|---|
| CODE | 104.31.60 | 104.31.62 |
| DEPTH | 1,20 m | 1,50 m |
| WATER VOLUME | 52,80 m ³ | 67,20 m ³ |
| RECIRCULATION RATE | 4 hours - 13,20 m ³ /h | 4 hours - 16,80 m ³ /h |
| RECOMMENDED RATE | 15,00 m ³ /h | 18,00 m ³ /h |
| PUMP | 1,00hp | 1,50hp |
| PUMP BASE | 1 Plastic | 1 Plastic |
| SAND FILTER | Ø635 | Ø635 |
| SAND | 175 kg | 175 kg |
| SKIMMERS | 2 Extended Liner | 2 Extended Liner |
| INLETS | 5 Wall Inlets Liner (1 is for the Water Regulator) | 5 Wall Inlets Liner (1 is for the Water Regulator) |
| MAIN DRAIN | 1 Compact Liner | 1 Compact Liner |
| LIGHTS | 2 Niche 18W/12V Cool White Liner | 2 Niche 18W/12V Cool White Liner |
| LIGHTING CABLE | 40 meters of H07RN-F | 40 meters of H07RN-F |
| ELECTRICAL PANEL | 1 Single phase for Pump and Lighting | 1 Single phase for Pump and Lighting |
| TRANSFORMER | 1 of 100W IP68 Closed type 220V/12V AC | 1 of 100W IP68 Closed type 220V/12V AC |
| WATER LEVEL REGULATOR | 1 item | 1 item |
| PVC MEMBRANE (LINER) | 3 Rolls Premium Azzure Blue | 3 Rolls Premium Azzure Blue |
| LIQUID PVC | 1 Azzure Blue | 1 Azzure Blue |
| STEEL PANELS | 1,2 m Height | 1,5 m Height |
| STAIR | INOX304, Standard 2 levels | INOX304, Standard 3 levels |
| PREFABRICATED PUMP ROOM | 1 Type Forest | 1 Type Forest |
| PVC ACCESSORIES | All Included | All Included |
| PIPING | All Included | All Included |
| ADHESIVE | 3 PVC Cement | 3 PVC Cement |
| COST OF MATERIALS* | 25,900.00€ * | 30,500.00€ * |
| *Conditions | *Prices do not include transportation and installation costs as well as VAT | |

Steel Panel Complete swimming pool Kit 4,8m (W) X 12m (L)

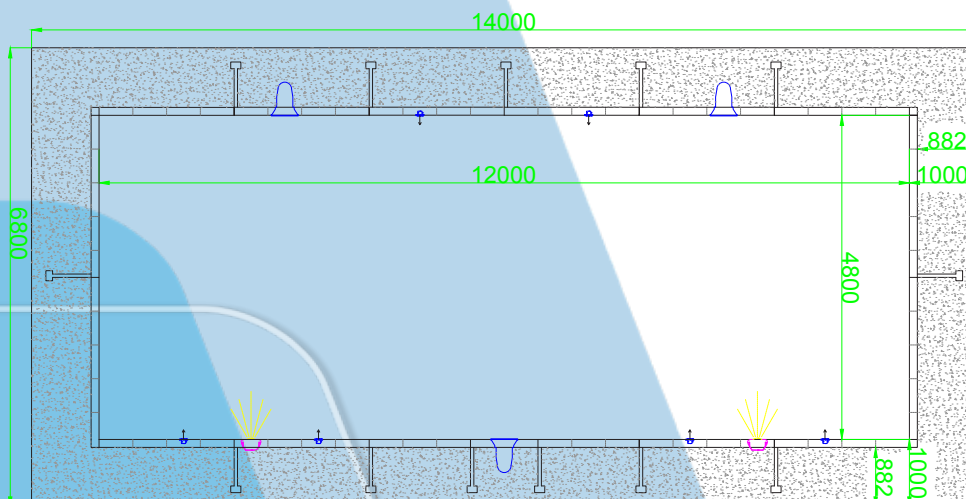

| | | |
|----------------------------|---|---|
| CODE | 104.31.64 | 104.31.66 |
| DEPTH | 1,20 m | 1,50 m |
| WATER VOLUME | 63,40 m ³ | 80,60 m ³ |
| RECIRCULATION RATE | 4 hours - 15,85 m ³ /h | 4 hours - 20,15 m ³ /h |
| RECOMMENDED RATE | 18,00 m ³ /h | 22,00 m ³ /h |
| PUMP | 1,50hp | 2,00hp |
| PUMP BASE | 1 Plastic | 1 Plastic |
| SAND FILTER | Ø635 | Ø710 |
| SAND | 175 kg | 250 kg |
| SKIMMERS | 3 Extended Liner | 3 Extended Liner |
| INLETS | 7 Wall Inlets Liner (1 is for the Water Regulator) | 7 Wall Inlets Liner (1 is for the Water Regulator) |
| MAIN DRAIN | 1 Compact Liner | 1 Compact Liner |
| LIGHTS | 3 Niche 18W/12V Cool White Liner | 3 Niche 18W/12V Cool White Liner |
| LIGHTING CABLE | 60 meters of H07RN-F | 60 meters of H07RN-F |
| ELECTRICAL PANEL | 1 Single phase for Pump and Lighting | 1 Single phase for Pump and Lighting |
| TRANSFORMER | 1 of 100W IP68 Closed type 220V/12V AC | 1 of 100W IP68 Closed type 220V/12V AC |
| WATER LEVEL REGULATOR | 1 item | 1 item |
| PVC MEMBRANE (LINER) | 3 Rolls Premium Azzure Blue | 3 Rolls Premium Azzure Blue |
| LIQUID PVC | 1 Azzure Blue | 1 Azzure Blue |
| STEEL PANELS | 1,2 m Height | 1,5 m Height |
| STAIR | INOX304, Standard 2 levels | INOX304, Standard 3 levels |
| PREFABRICATED PUMP ROOM | 1 Type Forest | 1 Type Forest |
| PVC ACCESSORIES | All Included | All Included |
| PIPING | All Included | All Included |
| ADHESIVE | 3 PVC Cement | 3 PVC Cement |
| COST OF MATERIALS* | 27,900.00€ * | 32,900.00€ * |
| *Conditions | *Prices do not include transportation and installation costs as well as VAT | |

Steel Panel Complete swimming pool Kit 6m (W) X 12m (L)

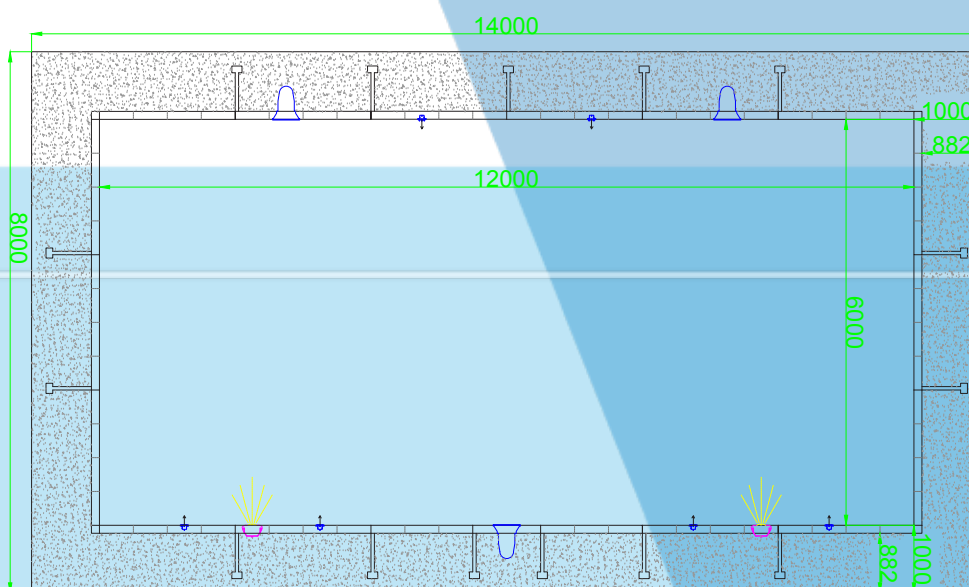

| | | |
|----------------------------|---|---|
| CODE | 104.31.68 | 104.31.70 |
| DEPTH | 1,20 m | 1,50 m |
| WATER VOLUME | 79,20 m ³ | 100,80 m ³ |
| RECIRCULATION RATE | 4 hours - 19,80 m ³ /h | 4 hours - 25,20 m ³ /h |
| RECOMMENDED RATE | 22,00 m ³ /h | 28,00 m ³ /h |
| PUMP | 2,00hp | 2,50hp |
| PUMP BASE | 1 Plastic | 1 Plastic |
| SAND FILTER | Ø710 | Ø710 |
| SAND | 250 kg | 250 kg |
| SKIMMERS | 3 Extended Liner | 3 Extended Liner |
| INLETS | 7 Wall Inlets Liner (1 is for the Water Regulator) | 7 Wall Inlets Liner (1 is for the Water Regulator) |
| MAIN DRAIN | 1 Compact Liner | 1 Compact Liner |
| LIGHTS | 3 Niche 18W/12V Cool White Liner | 3 Niche 18W/12V Cool White Liner |
| LIGHTING CABLE | 60 meters of H07RN-F | 60 meters of H07RN-F |
| ELECTRICAL PANEL | 1 Single phase for Pump and Lighting | 1 Single phase for Pump and Lighting |
| TRANSFORMER | 1 of 100W IP68 Closed type 220V/12V AC | 1 of 100W IP68 Closed type 220V/12V AC |
| WATER LEVEL REGULATOR | 1 item | 1 item |
| PVC MEMBRANE (LINER) | 4 Rolls Premium Azure Blue | 4 Rolls Premium Azure Blue |
| LIQUID PVC | 1 Azure Blue | 1 Azure Blue |
| STEEL PANELS | 1,2 m Height | 1,5 m Height |
| STAIR | INOX304, Standard 2 levels | INOX304, Standard 3 levels |
| PREFABRICATED PUMP ROOM | 1 Type Forest | 1 Type Forest |
| PVC ACCESSORIES | All Included | All Included |
| PIPING | All Included | All Included |
| ADHESIVE | 3 PVC Cement | 3 PVC Cement |
| COST OF MATERIALS* | 32,900.00€ * | 39,900.00€ * |
| *Conditions | *Prices do not include transportation and installation costs as well as VAT | |

Steel Panel Complete swimming pool Kit Roman End R1,5m / 4,8m (W) X 10m (L)

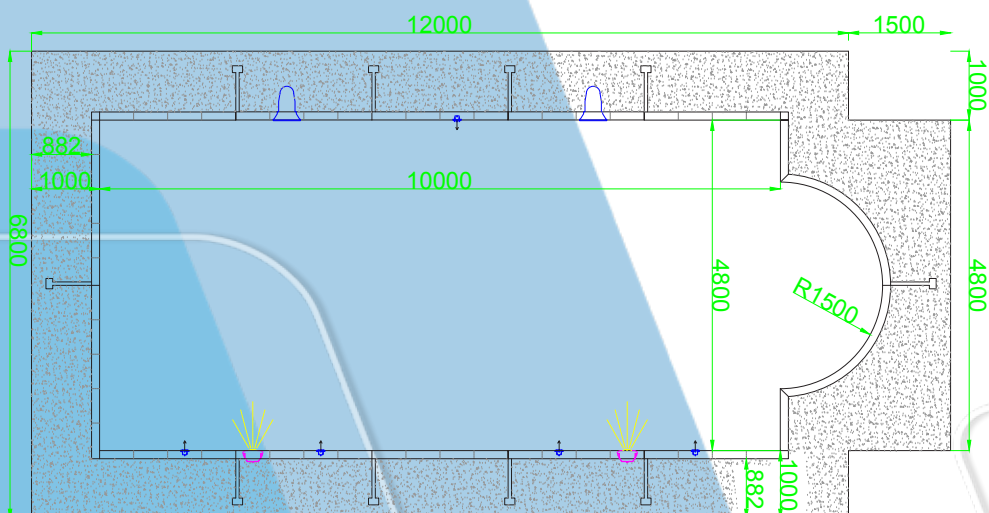

| | | |
|----------------------------|---|---|
| CODE | 104.31.72 | 104.31.74 |
| DEPTH | 1,20 m | 1,50 m |
| WATER VOLUME | 54,80 m ³ | 70,00 m ³ |
| RECIRCULATION RATE | 4 hours - 13,70 m ³ /h | 4 hours - 17,50 m ³ /h |
| RECOMMENDED RATE | 15,00 m ³ /h | 18,00 m ³ /h |
| PUMP | 1,00hp | 1,50hp |
| PUMP BASE | 1 Plastic | 1 Plastic |
| SAND FILTER | Ø635 | Ø635 |
| SAND | 175 kg | 175 kg |
| SKIMMERS | 2 Extended Liner | 2 Extended Liner |
| INLETS | 5 Wall Inlets Liner (1 is for the Water Regulator) | 5 Wall Inlets Liner (1 is for the Water Regulator) |
| MAIN DRAIN | 1 Compact Liner | 1 Compact Liner |
| LIGHTS | 2 Niche 18W/12V Cool White Liner | 2 Niche 18W/12V Cool White Liner |
| LIGHTING CABLE | 50 meters of H07RN-F | 50 meters of H07RN-F |
| ELECTRICAL PANEL | 1 Single phase for Pump and Lighting | 1 Single phase for Pump and Lighting |
| TRANSFORMER | 1 of 100W IP68 Closed type 220V/12V AC | 1 of 100W IP68 Closed type 220V/12V AC |
| WATER LEVEL REGULATOR | 1 item | 1 item |
| PVC MEMBRANE (LINER) | 4 Rolls Premium Azzure Blue | 4 Rolls Premium Azzure Blue |
| LIQUID PVC | 1 Azzure Blue | 1 Azzure Blue |
| STEEL PANELS | 1,2 m Height | 1,5 m Height |
| STAIR | INOX304, Standard 2 levels | INOX304, Standard 3 levels |
| PREFABRICATED PUMP ROOM | 1 Type Forest | 1 Type Forest |
| PVC ACCESSORIES | All Included | All Included |
| PIPING | All Included | All Included |
| ADHESIVE | 3 PVC Cement | 3 PVC Cement |
| COST OF MATERIALS* | 28,900.00€ * | 36,300.00€ * |
| *Conditions | *Prices do not include transportation and installation costs as well as VAT | |

Steel Panel Complete swimming pool Kit Roman R 1,5 / 4,8m (W) X 12m (L)

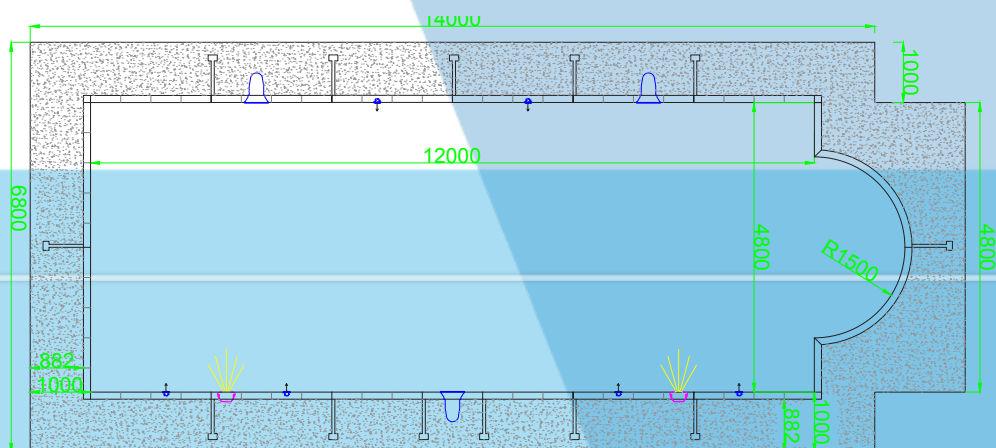

| | | |
|----------------------------|---|---|
| CODE | 104.31.76 | 104.31.78 |
| DEPTH | 1,20 m | 1,50 m |
| WATER VOLUME | 65,83 m ³ | 83,79 m ³ |
| RECIRCULATION RATE | 4 hours - 16,46 m ³ /h | 4 hours - 20,94 m ³ /h |
| RECOMMENDED RATE | 18,00 m ³ /h | 22,00 m ³ /h |
| PUMP | 1,50hp | 2,00hp |
| PUMP BASE | 1 Plastic | 1 Plastic |
| SAND FILTER | Ø635 | Ø710 |
| SAND | 175 kg | 250 kg |
| SKIMMERS | 3 Extended Liner | 3 Extended Liner |
| INLETS | 7 Wall Inlets Liner (1 is for the Water Regulator) | 7 Wall Inlets Liner (1 is for the Water Regulator) |
| MAIN DRAIN | 1 Compact Liner | 1 Compact Liner |
| LIGHTS | 3 Niche 18W/12V Cool White Liner | 3 Niche 18W/12V Cool White Liner |
| LIGHTING CABLE | 60 meters of H07RN-F | 60 meters of H07RN-F |
| ELECTRICAL PANEL | 1 Single phase for Pump and Lighting | 1 Single phase for Pump and Lighting |
| TRANSFORMER | 1 of 100W IP68 Closed type 220V/12V AC | 1 of 100W IP68 Closed type 220V/12V AC |
| WATER LEVEL REGULATOR | 1 item | 1 item |
| PVC MEMBRANE (LINER) | 4 Rolls Premium Azzure Blue | 4 Rolls Premium Azzure Blue |
| LIQUID PVC | 1 Azzure Blue | 1 Azzure Blue |
| STEEL PANELS | 1,2 m Height | 1,5 m Height |
| STAIR | INOX304, Standard 2 levels | INOX304, Standard 3 levels |
| PREFABRICATED PUMP ROOM | 1 Type Forest | 1 Type Forest |
| PVC ACCESSORIES | All Included | All Included |
| PIPING | All Included | All Included |
| ADHESIVE | 3 PVC Cement | 3 PVC Cement |
| COST OF MATERIALS* | 31,600.00€ * | 40,500.00€ * |
| *Conditions | *Prices do not include transportation and installation costs as well as VAT | |

Steel Panel Complete swimming pool Kit Roman R 2,0 / 6m (W) X 12m (L)

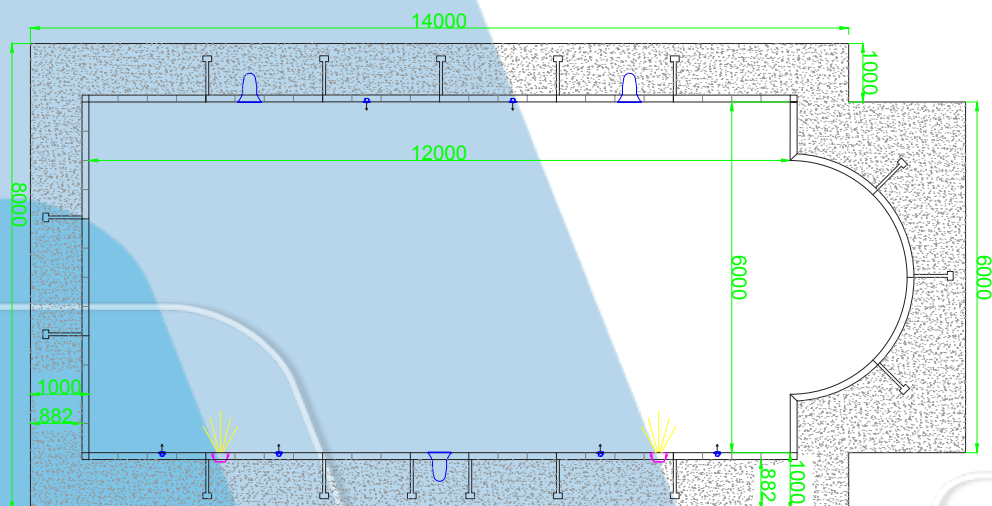

| | | |
|----------------------------|---|---|
| CODE | 104.31.80 | 104.31.82 |
| DEPTH | 1,20 m | 1,50 m |
| WATER VOLUME | 83,26 m ³ | 105,90 m ³ |
| RECIRCULATION RATE | 4 hours - 20,81 m ³ /h | 4 hours - 26,45 m ³ /h |
| RECOMMENDED RATE | 22,00 m ³ /h | 28,00 m ³ /h |
| PUMP | 2,00hp | 2,50hp |
| PUMP BASE | 1 Plastic | 1 Plastic |
| SAND FILTER | Ø710 | Ø710 |
| SAND | 250 kg | 250 kg |
| SKIMMERS | 3 Extended Liner | 3 Extended Liner |
| INLETS | 7 Wall Inlets Liner (1 is for the Water Regulator) | 7 Wall Inlets Liner (1 is for the Water Regulator) |
| MAIN DRAIN | 1 Compact Liner | 1 Compact Liner |
| LIGHTS | 3 Niche 18W/12V Cool White Liner | 3 Niche 18W/12V Cool White Liner |
| LIGHTING CABLE | 60 meters of H07RN-F | 60 meters of H07RN-F |
| ELECTRICAL PANEL | 1 Single phase for Pump and Lighting | 1 Single phase for Pump and Lighting |
| TRANSFORMER | 1 of 100W IP68 Closed type 220V/12V AC | 1 of 100W IP68 Closed type 220V/12V AC |
| WATER LEVEL REGULATOR | 1 item | 1 item |
| PVC MEMBRANE (LINER) | 4 Rolls Premium Azzure Blue | 4 Rolls Premium Azzure Blue |
| LIQUID PVC | 1 Azzure Blue | 1 Azzure Blue |
| STEEL PANELS | 1,2 m Height | 1,5 m Height |
| STAIR | INOX304, Standard 2 levels | INOX304, Standard 3 levels |
| PREFABRICATED PUMP ROOM | 1 Type Forest | 1 Type Forest |
| PVC ACCESSORIES | All Included | All Included |
| PIPING | All Included | All Included |
| ADHESIVE | 3 PVC Cement | 3 PVC Cement |
| COST OF MATERIALS* | 34,900.00€ * | 41,900.00€ * |
| *Conditions | *Prices do not include transportation and installation costs as well as VAT | |

Steel Panels of 1,2m Height

| CODE | Height (mm) | Width (mm) | Wall Thick. (mm) | Steel Thick. (mm) | Z supports needed | PRICE |
|-----------|-------------|------------|------------------|-------------------|-------------------|----------|
| 104.31.00 | 1200 | 500 | 120 | 2 | - | 142,13 € |
| 104.31.01 | 1200 | 750 | 120 | 2 | 1 | 196,29 € |
| 104.31.02 | 1200 | 1000 | 120 | 2 | 1 | 250,45 € |
| 104.31.03 | 1200 | 1250 | 120 | 2 | 2 | 304,62 € |
| 104.31.04 | 1200 | 1500 | 120 | 2 | 2 | 358,78 € |
| 104.31.05 | 1200 | 1750 | 120 | 2 | 2 | 412,94 € |
| 104.31.06 | 1200 | 2000 | 120 | 2 | 3 | 467,11 € |
| 104.31.07 | 1200 | 2250 | 120 | 2 | 3 | 521,27 € |
| 104.31.08 | 1200 | 2500 | 120 | 2 | 3 | 575,44 € |
| 104.31.09 | 1200 | 2750 | 120 | 2 | 4 | 669,46 € |
| 104.31.10 | 1200 | 3000 | 120 | 2 | 4 | 683,76 € |

Steel Panels of 1,5m Height

| CODE | Height (mm) | Width (mm) | Wall Thick. (mm) | Steel Thick. (mm) | Z supports needed | PRICE |
|-----------|-------------|------------|------------------|-------------------|-------------------|----------|
| 104.31.14 | 1500 | 500 | 120 | 2 | - | 170,77 € |
| 104.31.15 | 1500 | 750 | 120 | 2 | 1 | 235,85 € |
| 104.31.16 | 1500 | 1000 | 120 | 2 | 1 | 300,93 € |
| 104.31.17 | 1500 | 1250 | 120 | 2 | 1 | 366,01 € |

For 1,2m height panel

| CODE | Description | Steel Thick. (mm) | Pcs | PRICE |
|-----------|---------------------------|-------------------|-----|--------|
| 104.31.11 | Z support | 2 | 1 | 27,65€ |
| 104.31.12 | Strut Support | 2 | 4 | 69,99€ |
| 104.31.13 | Corner | 2 | 1 | 49,03€ |
| 104.21.36 | Set Screw/Bolt/Washer M12 | | 1 | 1,32€ |

Supporting Parts

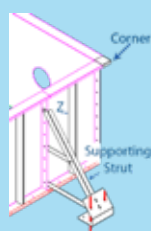

For 1,5m height panel

| CODE | Description | Steel Thick. (mm) | Pcs | PRICE |
|-----------|---------------------------|-------------------|-----|--------|
| 104.31.18 | Z support | 2 | 1 | 34,60€ |
| 104.31.19 | Strut Support | 2 | 4 | 74,34€ |
| 104.31.20 | Corner | 2 | 1 | 58,91€ |
| 104.21.36 | Set Screw/Bolt/Washer M12 | | 1 | 1,32€ |

Steel Overflow Channel

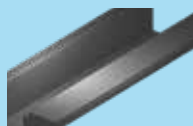

| CODE | Length (mm) | Steel Thick. (mm) | Grating width (mm) | PRICE |
|-----------|-------------|-------------------|--------------------|---------|
| 104.31.21 | 1000 | 2 | 150 | 240,45€ |
| 104.31.22 | 1000 | 2 | 200 | 266,53€ |
| 104.31.23 | 1000 | 2 | 250 | 297,61€ |
| 104.31.24 | 1000 | 2 | 300 | 329,78€ |

| CODE | Description | Steel Thick. | Pcs/ m | PRICE |
|-----------|-----------------|--------------|--------|--------|
| 104.31.25 | Channel Support | 2 | 2 | 29,90€ |

Aluminium Oxide Coating



| CODE | Panel Height (mm) | PRICE / lin.m |
|--------|-------------------|---------------|
| LLP001 | 1200 | 185,74€ |
| LLP003 | 1500 | 197,18€ |

Steel Panels of 1,2m & 1,5m Height with Radius for Roman End pools



| CODE | Height (mm) | Radius (mm) | Arc Length | Pcs Needed | Wall Thick. (mm) | Steel Thick. (mm) | Z supports TOTAL | PRICE TOTAL |
|-----------|-------------|-------------|------------|------------|------------------|-------------------|------------------|-------------|
| 104.31.27 | 1200 | 1000 | 1570 | 2 | 120 | 2 | 4 | 1.435,82 € |
| 104.31.28 | 1200 | 1500 | 2235 | 2 | 120 | 2 | 6 | 2.393,03 € |
| 104.31.29 | 1200 | 2000 | 2100 | 3 | 120 | 2 | 9 | 3.031,17 € |
| 104.31.30 | 1200 | 2500 | 2610 | 3 | 120 | 2 | 12 | 3.350,24 € |
| 104.31.32 | 1500 | 1000 | 1050 | 3 | 120 | 2 | 3 | 1.754,88 € |
| 104.31.33 | 1500 | 1500 | 1180 | 4 | 120 | 2 | 4 | 2.871,64 € |
| 104.31.34 | 1500 | 2000 | 1050 | 6 | 120 | 2 | 6 | 3.509,78 € |
| 104.31.35 | 1500 | 2500 | 1120 | 7 | 120 | 2 | 7 | 4.626,52 € |

Sherwood Plug & Swim Pools

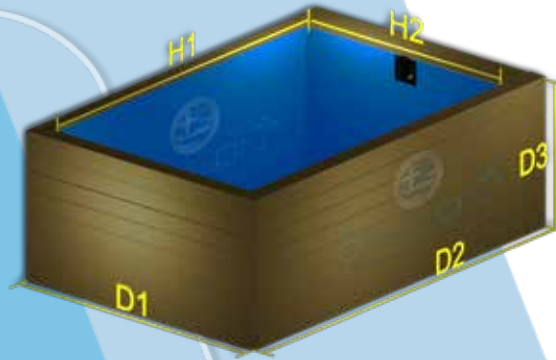

| CODE | D1 | D2 | D3 | H1 | H2 | PRICE |
|-----------|-------|-------|-------|-------|-------|------------|
| 104.31.90 | 2,10m | 2,45m | 1,00m | 2,00m | 1,80m | 13,900.00€ |
| 104.31.91 | 2,10m | 2,95m | 1,00m | 2,50m | 1,80m | 15,500.00€ |
| 104.31.92 | 2,10m | 3,45m | 1,00m | 3,00m | 1,80m | 17,900.00€ |

Sherwood Prefabricated Swimming Pool Features:

- Complete E / M equipment with pump, sand filter, electric panel, skimmer, LED lights, inlet, piping network.
- Steel pool panels
- Pool lining with liner
- Metal perimeter frame
- Perimeter lining with Deck WPC
- 100% Greek product

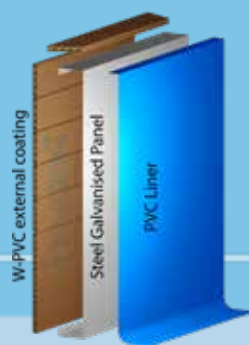

Side step for access and pump room

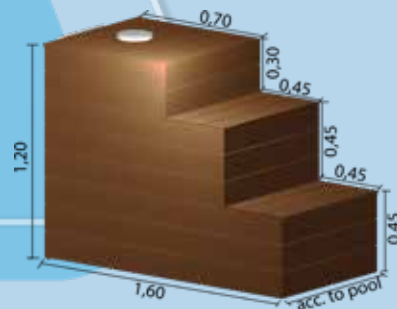

Available Extras

| CODE | Description | Pcs | PRICE |
|-----------|---|-----|-----------|
| 105.01.46 | 12V / 18W Underwater light cool White | 1 | 245.00€ |
| 105.21.11 | Electric Pool Board control IP65 CE | 1 | 690.14€ |
| 105.05.18 | Lights transformer 100W IP68 CE | 1 | 141.48€ |
| 104.31.87 | Side step for access and pump room for D2 2,45m | 1 | 1,900.00€ |
| 104.31.88 | Side step for access and pump room for D2 2,95m | 1 | 2,900.00€ |
| 104.31.89 | Side step for access and pump room for D2 3,45m | 1 | 3,900.00€ |

Octagon Plug & Swim Pools

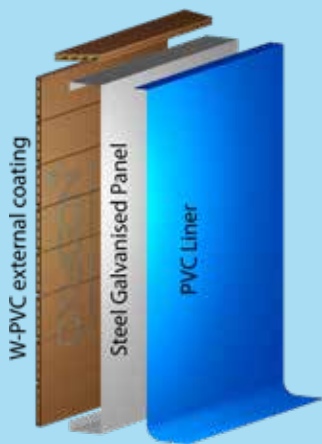

Octagon Complete Swimming Pool

Features:

- The best Plug & Swim pool in the world
- Arrives in parts to be assembled on site
- Can add water features such as waterfall or spa area
- Selection of colours for the liner of the pool and the surrounding W-PVC decking
- 100% made in Greece

INCLUDING:

- Steel Panels
 - Decking W-PVC coating in several colours
 - Liner in several colours
 - Mini pump 0,50hp, cartridge filter 5,5m³/h, skimmer and inlet
- NEEDS ASSEMBLY depending the model**

Side step for access and pump room

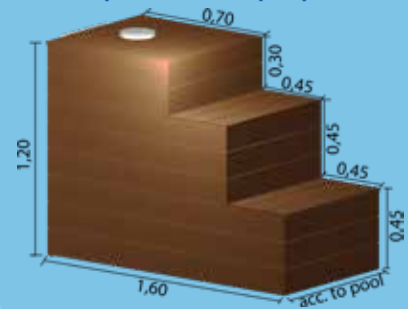

| CODE | H (height) | D (Diagonal) | W1 | W2 | Area total (m ²) | Needs Assembly | PRICE |
|-----------|------------|--------------|-------|-------|------------------------------|----------------|------------|
| 104.32.83 | 1,0m | 1,87m | 1,73m | 2,03m | 3,42 m ² | NO | 7,887.42€ |
| 104.31.84 | 1,0m | 2,20m | 2,05m | 2,35m | 4,50 m ² | YES | 8,216.06€ |
| 104.31.85 | 1,0m | 3,45m | 3,20m | 3,50m | 10,00 m ² | YES | 11,831.14€ |
| 104.31.86 | 1,0m | 4,70m | 4,40m | 4,70m | 19,00 m ² | YES | 16,103.48€ |

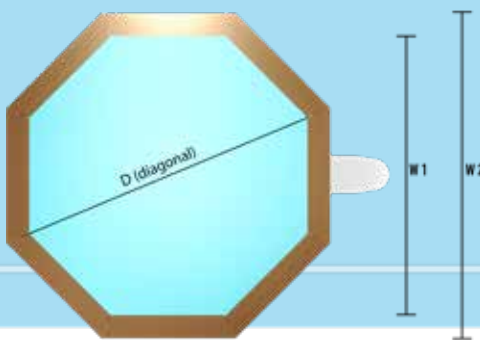

Available Extras

| CODE | Description | Pcs | PRICE |
|-----------|---|-----|-----------|
| 105.01.46 | 12V / 18W Underwater light cool White | 1 | 245.00€ |
| 105.21.11 | Electric Pool Board control IP65 CE | 1 | 690.14€ |
| 105.05.18 | Lights transformer 100W IP68 CE | 1 | 141.48€ |
| 104.31.87 | Side step for access and pump room for D2 2,45m | 1 | 1,610.34€ |
| 104.31.88 | Side step for access and pump room for D2 2,95m | 1 | 2,596.28€ |
| 104.31.89 | Side step for access and pump room for D2 3,45m | 1 | 3,253.55€ |



OXYGON⁺

Disinfection Systems

Mini Salt Chlorinator - SR Series

The SR series is the best disinfection choice especially designed for pools up to 45m³ and SPA. Chlorine disinfection was never more easy, just by adding salt to a swimming pool and produce active chlorine. Designed to co-operate with SPA ozone systems. The SR series salt chlorinator is easy to maintain by its titanium self cleaning cells function and easy to use control panel. With SR series salt chlorinator you will never have the problems of traditional chlorination.



Featured Highlights:

- The compact design of SR series salt chlorinator is ideally used for small pools no more than 45m³.
- It comes with support brackets, meeting all kind of installation types and easily installed at tight spaces.
- Can be directly connected with flexible hose in 32/38mm reducer fittings or PVC pipe Ø50.
- Integrates water flow switch, water temperature sensor and salinity monitor, to easily monitor the water quality.
- Preset multiple intelligent operation modes, one-button switching, simple operation, time and worry saving.
- It alerts about abnormalities with the built-in warning function.
- The square housing design saves storage and packaging space, which can reduce shipping and storage costs.
- The unique housing design with the transparent material offers easy observation of the operation.

| CODE | MODEL | CHLORINE g/h | POOL VOLUME at 25°C | SALT LEVEL | PRICE |
|-----------|-------|--------------|------------------------|-----------------|---------|
| 108.14.17 | SR050 | 5 | 11 - 22 m ³ | 2700 - 4500 ppm | 687.01€ |

Salt Chlorinator EC Series

The Oxygen EC salt chlorinator applied advanced micro-computer technology, to provide the most energy saving and environmental friendly method to sanitize small and medium pools. To achieve this simple, smart and safe chlorine production, all the chlorinator requires is salt.



Featured Highlights:

- Simple to use, simple to operate, install, and simple to operate, and simple to maintain.
- Chlorine output is adjustable from 20% to 100% by simply pressing two buttons, satisfying different needs for different pools.
- Self-cleaning function by reversing the polarity automatically, which prevents calcium from accumulating and therefore prolongs the cell's lifetime.
- Fault auto alarm with error code, which is easy to find corresponding solutions.
- When the water temperature is too high or too low, the chlorinator will automatically stop running, in order to protect the unit and prolong the cell. The integrated sensors in the cell also ensure that water flow is adequate for safe chlorine generation.
- Each time the chlorinator restarts, it can automatically initiate the last work status, with this smart memory function.
- Safe disinfection, safe water quality, and safe working voltage.

| CODE | MODEL | CHLORINE g/h | POOL VOLUME at 25°C | SALT LEVEL | PRICE |
|-----------|-------|--------------|---------------------|------------|-----------|
| 108.14.21 | EC08 | 08 | 40 m ³ | 3500 ppm | 955.86€ |
| 108.14.22 | EC12 | 12 | 60 m ³ | 3500 ppm | 1,097.34€ |
| 108.14.23 | EC16 | 16 | 80 m ³ | 3500 ppm | 1,204.31€ |
| 108.14.24 | EC20 | 20 | 100 m ³ | 3500 ppm | 1,311.28€ |

Salt Chlorinator EC PRO Series

The EC Pro series salt chlorinator has an intelligent self-adjustment function for optimal performance. Easily manage your pool disinfection via an app on your smartphone or tablet, ensuring crystal clear, disinfected water anytime, anywhere. Adjust your pool size and get smart reminders to maintain the ideal salt level (3500 ppm) during low salt conditions. The Smart Life app allows remote control and network management of the chlorinator.



Featured Highlights:

- **Intelligent Control:** Manage the EC Pro salt chlorinator through the TUNA app.
- **Self-Adapting Operation:** The chlorinator adjusts to reduce chlorine production during low salt conditions in the pool.
- **Salt Shortage Reminder:** Receive notifications for the required amount of salt when levels are low.
- **Self-Cleaning Function:** Prevents calcium buildup on titanium plates with automatic polarity reversal. The reversal intervals can be set to 2, 4, 6, or 8 hours.
- **Chlorine Production Adjustment:** Easily adjust chlorine production with the press of a button or through the app.
- **One-Click Boost:** Quickly increase chlorine production to eliminate microorganisms and break down ammonia, suitable for various situations.
- **Power Outage Memory:** Automatically restores the previous operating state after a power outage.
- **Safety Mode:** Automatically shuts off when low water levels are detected to prevent damage to the equipment.

| CODE | MODEL | CHLORINE g/h | POOL VOLUME at 25°C | SALT LEVEL | PRICE |
|-----------|-----------|--------------|---------------------|------------|-----------|
| 108.14.40 | EC-PRO 08 | 08 | 40 m ³ | 3500 ppm | 1,197.50€ |
| 108.14.41 | EC-PRO 12 | 12 | 60 m ³ | 3500 ppm | 1,347.50€ |
| 108.14.42 | EC-PRO 16 | 16 | 80 m ³ | 3500 ppm | 1,447.50€ |
| 108.14.43 | EC-PRO 20 | 20 | 100 m ³ | 3500 ppm | 1,572.50€ |

Oxygon OXY-Pool Pool Water Treatment System

INCLUDES

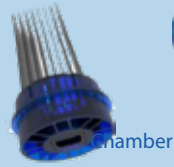

Titanium Electrode



KIT pH











(MP2-B pump, pH probe, buffer solution, temperature probe, pipes, bottom filter, injection valve)



NO CHEMICALS
CHLORINE
SALT

3 TIMES MORE
EFFECTIVE THAN
CHLORINE

ABOT®
TECHNOLOGY
ADVANCED BI-POLAR
OXIDATION TECHNOLOGY

| FEATURES | DETAILS |
|--|--|
|  HYDROLYSIS | Disinfection of water and oxidation of organic elements through hydroxyls ions |
|  IONIZATION | Residual copper ionization to optimize the disinfection process |
|  PH CONTROL | Automatic pH control and setting |
|  ORP CONTROL | Automatic ORP control and setting |
|  CHLORINE CONTROL | Automatic CHLORINE control and setting |
|  TEMPERATURE | Detection of the pool water temperature by a specific probe |
|  LEVEL PROBE | Automatic alarm in case of exhaustion of the chemical product in the tank |
|  FLOW SENSOR | Automatic alarm that alerts and disables all outputs in case of no water flow |
|  ANTISCALE SYSTEM | Ecological anti-scale system using magnetic fields |
|  OUTPUTS | N° 2 outputs mA range 0/4÷20 mA - N° 5 programmable outputs - N° 5 outputs dry relay |
|  CIRCULATION PUMP | Automatic adjustment of the filtration pump. Operation status check |
|  HEAT PUMP | Automatic control of the heat pump. Control of operating status |
|  POOL COVER | Automatic reduction of Oxy / Ion operation with covered pool |
|  LIGHTING | Programmable switching on / off of the pool lighting |
|  WINTER FUNCTION | Automatic operation of the recirculation pump to prevent ice formation |
|  PASSWORD | N.2 programming levels: EXPERT / INSTALLER |

| CODE | MODEL | POOL VOLUME | CELL PLATES | pH PUMP MP2-B | cL PUMP MP2-B* | PRICE |
|-----------|------------------------|--------------------|-------------|---------------|----------------|------------|
| 250.01.05 | SPA20 + pH | 20 m ³ | 4 | 0,1 l/h | 0,1 l/h | 8,644.56€ |
| 250.01.06 | HOME50 + pH | 50 m ³ | 5 | 1,5 l/h | 3,0 l/h | 8,823.42€ |
| 250.01.07 | HOME50 + pH + RX | 50 m ³ | 5 | 1,5 l/h | 3,0 l/h | 9,161.25€ |
| 250.01.08 | HOME80 + pH | 80 m ³ | 6 | 1,5 l/h | 3,0 l/h | 9,141.38€ |
| 250.01.09 | HOME80 + pH + RX | 80 m ³ | 6 | 1,5 l/h | 3,0 l/h | 9,359.98€ |
| 250.01.10 | HOME125 + pH | 125 m ³ | 7 | 1,5 l/h | 3,0 l/h | 9,320.23€ |
| 250.01.11 | HOME125 + pH + RX | 125 m ³ | 7 | 1,5 l/h | 3,0 l/h | 9,658.06€ |
| 250.01.12 | HOME175 + pH | 175 m ³ | 8 | 1,5 l/h | 3,0 l/h | 9,509.02€ |
| 250.01.13 | HOME175 + pH + RX | 175 m ³ | 8 | 1,5 l/h | 3,0 l/h | 9,846.85€ |
| 250.01.14 | PUBLIC400/2 4TI + pH | 400 m ³ | 12-16 | 1,5 l/h | 3,0 l/h | 14,715.63€ |
| 250.01.15 | Ecological Antiscaling | | - | | | 434.02€ |
| 250.01.16 | Sensor level CL/pH/flo | | - | | | 187.80€ |

- Complete water treatment system through hydrolysis and ionization.
- Disinfection of water and oxidation of organic elements through hydroxide ions.
- Residualization of copper for the optimization of the disinfection process (algacide effect and water clarification).
- Automatic operating: automatic adjustment of pH, redox, chlorine, water temperature, recirculation pump and all programmed outputs.
- Manual operating: manual adjustment of all functions.
- Winter function (NOFROST): automatic activation of the recirculation pump to prevent the formation of ice.
- Instant display of the pH value (0 ÷ 14 pH), Redox (0 ÷ 1000 mV), chlorine (0 ÷ 20 ppm), temperature (° C / ° F), detected through the various configurable probes.
- mA outputs: up to 2 mA outputs fully programmable on the 0/4 ÷ 20 mA range useful for managing mA pumps.
- Programmable powered outputs: a total of 5 programmable powered outputs.
- Programmable dry relay outputs: 5 programmable relay outputs (voltage free contact).
- Alarms: greater safety thanks to numerous automatic alarms on all controlled parameters.
- Alarm email: automatic sending of emails to the desired addresses in case of an alarm.
- 3 protected programming levels (password): user (free) for basic settings, expert (password) to access more complex settings and installer (changeable password) to access device configurations.
- Recirculation pump management / control: automatic adjustment of the filtration pump (management of filtering hours based on the water temperature or based on pre-set programs).
- Operating status check.
- Pool cover detection function.
- Lighting management: programmable switching ON/ OFF for pool lighting.
- History of the measurements of the previous months
- Geolocalization: useful function for the installer to locate the customer more quickly.
- Multi-language menu: operating system available in various languages (Italian, English, Spanish, French, German, Dutch, Russian).
- Quick installation user manual: quick installation guide.
- Complete user manual available online.
- Help on device: quick explanation of each function within the menu.
- Flow sensor: automatic alarm that alerts and disables all outlets in case of no water flow in the pipes.
- Level probe predisposition: automatic alarm that warns in case of exhaustion of the chemical product in the tank.
- Predisposition for anti-limescale system: ecological anti-limescale system using magnetic fields.
- Wifi / ethernet connection: communication with the server to manage information on the pooltec-pro platform.
- Web control: server for managing records, communications, and updates.
- Android / iOS app: via the Android / iOS app it is possible to remotely control all the parameters and alarms of the pool.
- Display touch screen 10".
- Easy access to the connection compartment: easy opening with practical locking system.
- Power Supply 100÷240Vac 50Hz.
- Power cable with Schuko plug.
- Case in ABS: maximum compatibility with common chemicals.
- Protection IP65
- 100 % Made in Italy In compliance with CE regulations

Oxygon OXY-Pool Parts

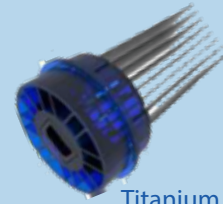

Titanium Electrode

| CODE | Description | PRICE |
|-----------|----------------------------|-----------|
| 250.01.23 | Titanium Electrode 4 Cells | 983.69€ |
| 250.01.24 | Titanium Electrode 5 Cells | 1,232.10€ |
| 250.01.25 | Titanium Electrode 6 Cells | 1,460.63€ |
| 250.01.26 | Titanium Electrode 7 Cells | 1,619.61€ |
| 250.01.27 | Titanium Electrode 8 Cells | 1,927.63€ |

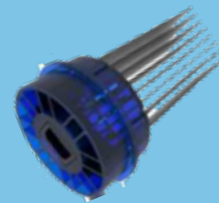

Low Conductivity Titanium Electrode

| CODE | Description | PRICE |
|-----------|---|-----------|
| 250.01.28 | Low Conductivity Titanium Electrode 4 Cells | 1,043.31€ |
| 250.01.29 | Low Conductivity Titanium Electrode 5 Cells | 1,301.65€ |
| 250.01.30 | Low Conductivity Titanium Electrode 6 Cells | 1,550.06€ |
| 250.01.31 | Low Conductivity Titanium Electrode 7 Cells | 1,709.04€ |
| 250.01.32 | Low Conductivity Titanium Electrode 8 Cells | 2,036.94€ |

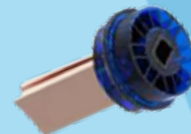

Copper Electrode

| CODE | Description | PRICE |
|-----------|------------------|-----------|
| 250.01.33 | Copper Electrode | 2,036.94€ |



Chamber

| CODE | Description | PRICE |
|-----------|---------------|---------|
| 250.01.34 | Empty Chamber | 298.09€ |

MP2-R



Description

- Peristaltic pump with adjustable flow rate by trimmer
- Reinforced PP body
- Polycarbonate front panel
- Standard 230 Vac Power Supply
- 10-100% speed regulation
- CE approved

| CODE | DESCRIPTION | PRICE |
|-----------|---------------------|---------|
| 108.05.21 | MP2-R, 0,15-1,5 l/h | 368.64€ |

MP2 Summer pH



Description

Peristaltic pump with built in PH controller. Easy Set Point programming between 7,2 and 7,4 PH interval. Semi automatic calibration with buffer 7,00 PH. Proportional dosing according to Set Point. ON / OFF function. The probe is included

| CODE | DESCRIPTION | PRICE |
|------------|------------------------------|---------|
| 108.05.203 | MP2-Summer-pH, 1,0 l/h, 1bar | 525.83€ |

MP2 SP pH / Rx



Description for pH

Digital proportional peristaltic pump for pH or Rx control. Semi automatic calibration with buffer pH 7.00 and 9.00 or 468mV for Rx. Alarm maximum dosage. Programming of set point between pH6.0 and 8,0. IP55. The probe is included

| CODE | DESCRIPTION | PRICE |
|------------|------------------------|---------|
| 108.05.200 | MP2-SP-pH, 3 l/h, 1bar | 690.14€ |
| 108.05.201 | MP2-SP-Rx, 3 l/h, 1bar | 690.14€ |

MP2 WiFi-Clever Ph/Rx



Specifications:

- 6lit/h at 1bar
- Installation KIT
- Wi-Fi connection and free smartphone app to view the pH / REDOX value in real time alarms with warnings and indications, set point, last calibration date and graph with historical measurements.
- Facilitated programming of the set point on a range between 6.0 and 8.0 pH / 300 and 800 mV.
- Calibration on a single value of 7.0 pH / 468 mV.
- Instant visualization of the pH / REDOX value on the display.
- Proportional operation with ON / OFF times of 150 seconds until the set point is reached.
- Time alarm for overdosing or end of product.
- Probe health status detection.

| CODE | DESCRIPTION | PRICE |
|-----------|------------------------------|---------|
| 750.09.35 | MP2WF-Clever Ph, 6 l/h, 1bar | 850.00€ |
| 750.09.40 | MP2WF-Clever Rx, 6 l/h, 1bar | 850.00€ |

MP2 HT All Functions



Specifications:

- Digital peristaltic pump for:
- PH or REDOX control setting by software or Chlorine Control, Manual, Pulses, ppm, mA, Quantity, Timer dos, Timer, instruments onboard
 - Suitable for dosing acidic or basic/oxidizing or reducing products
 - 3 different operating mode: Manual, ON/OFF, Proportional
 - 4 languages menu: Italian, English, French, Spanish
 - Backlit LCD Display 16 x 2
 - Power supply 90 ÷ 250 Vac 50-60 Hz
 - IP55 protection degree
 - Easy programming and minimum maintenance
 - CE approved

| CODE | DESCRIPTION | PRICE |
|-----------|---------------------------------------|---------|
| 108.05.40 | MP2 HT Ph/Redox 6 l/h incl. probe | 997.27€ |
| 108.05.41 | MP2 HT Chlorine 6 l/h probe NOT incl. | 997.27€ |
| 108.05.42 | MP2 HT Multifunction 6 l/h | 997.27€ |
| 108.05.43 | MP2 HT Pulses/PPM 6 l/h | 997.27€ |
| 108.05.44 | MP2 HT mA 6 l/h | 997.27€ |
| 108.05.45 | MP2 HT Timer 6 l/h | 997.27€ |



MP Pro pH / Rx / Cl₂

Peristaltic pump digital proportional control of pH/Redox definable choice. Backlit display. IP65. Flow sensor and alarm overdose. Display hundreds of reading. Multi language menu. The probe for pH or Rx is included. The Cl₂ probe cell is not included in the package

Specifications:

Digital dosing pump with integrated tool and 3 different types of function:

1. constant
2. ON/OFF,
3. proportional

Menu in 4 different languages, Italian, English, French, Spanish. Alarm time of overdose, delay starting programmable flow Control 8x2 backlit digital display LED status and programming case in arnite. Protection IP65 Over and Under range signal range of the measurement. Rate indication in % instant by instant Power cord 2.5 m Accessory Kit with injection lap valve.

| CODE | DESCRIPTION | PRICE |
|------------|---|-----------|
| 108.05.31 | MP-PRO pH/Rx, 6 l/h, 1bar | 980.01€ |
| 108.05.35 | MP-PRO Cl ₂ , 6 l/h, 1bar | 1,062.72€ |
| 108.05.32 | predisposition level probe | 34,51€ |
| 108.05.33 | flow alarm sensor | 65,57€ |
| 108.05.207 | Cl ₂ Probe for Inorganic Free Chlorine | 2,893.50€ |
| 108.05.208 | Cl ₂ Probe for Organic Free Chlorine | 2,893.50€ |



ME3 pH / Rx

Specifications:

Electromagnetic pump digital proportional control of pH/Redox definable choice Backlit display. IP65. Flow sensor and alarm overdose. Display hundreds of reading p.p.m. Multi language menu. For use with amperometric PRO-CG-CL3. The probe is included.

| CODE | DESCRIPTION | PRICE |
|-----------|----------------------------|-----------|
| 108.05.08 | ME3 pH/Rx, 10 l/h | 1,511.43€ |
| 108.05.09 | ME3 pH/Rx, 5 l/h | 1,511.43€ |
| 108.05.10 | ME3 pH/Rx, 24 l/h | 1,687.42€ |
| 108.05.11 | predisposition level probe | 34.51€ |
| 108.05.12 | flow alarm sensor | 65.57€ |



MP2 Pool for Antialgae and Flocculant

Specifications:

Digital timed peristaltic dosing pump ideal for dosing antialgae or flocculant

- Timed peristaltic pump
- Ideal for antialgae or flocculant
- Stand-By and Delay Start functions
- IP55

| CODE | DESCRIPTION | PRICE |
|-----------|-----------------------|---------|
| 108.05.39 | MP2 Pool, 6 l/h, 1bar | 410.64€ |



MP2 HP for Hydrogen Peroxide

Specifications:

Peristaltic dosing pump for use with Hydrogen Peroxide. Swimming pool volume (cubic meters) programmable by the user. Proportional dosing according to 2 parameters: duty time/swimming pool cubic meters. Residual dosing time showed in real time. Digital display with Stand-By button and 5 status led.

| CODE | DESCRIPTION | PRICE |
|-----------|--------------------------------|---------|
| 108.05.28 | MP2 Hydrogen Peroxide, 1,5 l/h | 914.44€ |



MMD-FER Membrane Version Motor Driven Metering Pump

- Mechanical membrane dosing pump
- Spring return mechanism
- Pump body made of painted aluminum std. RAL 7330
- Constant speed gearmotor
- High technology e high precision eccentric. Effective performance of 93%.
- Flow rate regulation done with linear Vernier from 0 to 100%
- Energy efficiency at high levels
- Electric motor c.v.e da 0,18kw gr. 63 B14 three- phase 230-400v. 4 poles 50 Hz IP 55
- Electric motor c.v.e da 0,37kw gr. 71 B14 three- phase 230-400v. 4 poles 50 Hz IP 55

| CODE | DESCRIPTION | FLOW RATE l/h | | BAR | FITTINGS | STROKE LENGTH DIAM. mm | VALVE mm | MOTOR kW | | PRICE |
|------------|---------------|---------------|-----|-----|----------|------------------------|----------|----------|------|-----------|
| | | MAX | MIN | | | | | 3PH | 1PH | |
| 108.05.213 | MMD-FER 50 B | 50 | 5 | 8 | 1/4" | 110 / 2 | 4 | 0,18 | 0,37 | 3,041.58€ |
| 108.05.214 | MMD-FER 115 B | 115 | 11 | 8 | 1/4" | 110 / 4 | 6 | 0,18 | 0,37 | 3,107.31€ |
| 108.05.215 | MMD-FER 250 B | 250 | 25 | 8 | 1/4" | 110 / 6 | 6 | 0,18 | 0,37 | 3,435.96€ |
| 108.05.216 | MMD-FER 480 B | 480 | 48 | 5 | 1/4" | 170 / 6 | 5 | 0,18 | 0,37 | 4,093.24€ |

Oxygon Pooltec

POOLTEC is the new and innovative fully digital multiparameter instrument for the control and regulation of pool water treatment.

- Control of pH / Redox / Chlorine / Temperature values.
- Automatic regulation of the recirculation pump.
 - Swimming pool lighting management
 - Other fully programmable outputs

The instrument integrates the most important and complete functions for a complete control of the pool

| FEATURES | DETAILS |
|------------------|---|
| PARAMETERS | Automatic reading and regulation of ph / redox / chlorine and temperature |
| WINTER FUNCTION | Automatic operation of the recirculation pump to prevent ice formation |
| OUTPUTS | N° 2 outputs mA range 0/4÷20 mA - N° 5 programmable outputs - N° 5 outputs dry relay |
| POOL COVER | Pool cover detection function |
| CIRCULATION PUMP | Automatic adjustment of the filtration pump. Operation status check |
| LEVEL PROBE | Level probe signal input |
| FLOW SENSOR | Automatic alarm that alerts and disables all outputs in case of no water flow |
| MENU | Operating system in various languages (Italian, English, French, Spanish, Russian, Dutch, German) |

- IoT multifunction instrument for the control of pH, redox, chlorine, temperature.
- Automatic operating: automatic adjustment of pH, redox, chlorine, water temperature, recirculation pump and all programmed outputs.
- Manual operating: manual adjustment of all functions.
- Winter function (NOFROST): automatic activation of the recirculation pump to prevent the formation of ice.
- Instant display of the pH value (0 ÷ 14 pH), Redox (0 ÷ 1000 mV), chlorine (0 ÷ 20 ppm), temperature (° C / ° F), detected through the various configurable probes.
- mA outputs: up to 2 mA outputs fully programmable on the 0/4 ÷ 20 mA range useful for managing mA pumps.
- Programmable powered outputs: a total of 5 programmable powered outputs.
- Programmable dry relay outputs: 5 programmable relay outputs (voltage free contact).
- Alarms: greater safety thanks to numerous automatic alarms on all controlled parameters.
- Alarm email: automatic sending of emails to the desired addresses in case of an alarm.
- 3 protected programming levels (password): user (free) for basic settings, expert (password) to access more complex settings and installer (changeable password) to access device configurations.
- Recirculation pump management / control: automatic adjustment of the filtration pump (management of filtering hours based on the water temperature or based on pre-set programs).
- Operating status check.
- Pool cover detection function.
- Lighting management: programmable switching ON/ OFF for pool lighting.
- History of the measurements of the previous months
- Geolocalization: useful function for the installer to locate the customer more quickly.
- Multi-language menu: operating system available in various languages (Italian, English, Spanish, French, German, Dutch, Russian).
- Quick installation user manual: quick installation guide.
- Complete user manual available online.
- Help on device: quick explanation of each function within the menu
- Flow sensor: automatic alarm that alerts and disables all outlets in case of no water flow in the pipes.
- Level probe predisposition: automatic alarm that warns in case of exhaustion of the chemical product in the tank.
- Predisposition for anti-limescale system: ecological anti-limescale system using magnetic fields.
- Wifi / ethernet connection: communication with the server to manage information on the pooltec-pro platform.
- Web control: server for managing records, communications, and updates.
- Android / iOS app: via the Android / iOS app it is possible to remotely control all the parameters and alarms of the pool.
- Display touch screen 10".
- Easy access to the connection compartment: easy opening with practical locking system.
- Power Supply 100÷240Vac 50Hz.
- Power cable with Schuko plug.
- Case in ABS: massima compatibilità con i comuni prodotti chimici.
- Protection IP65
- 100 % Made in Italy In compliance with CE regulations

| CODE | Description | PRICE |
|-----------|--------------------------------------|-----------|
| 250.01.01 | Oxygon Pooltec pH + T° | 4,153.36€ |
| 250.01.02 | Oxygon Pooltec pH + T° + Rx | 4,352.09€ |
| 250.01.03 | Oxygon Pooltec pH + T° + Rx + Cl amp | 4,550.82€ |
| 250.01.04 | Oxygon Pooltec pH + T° + Rx + Cl pot | 4,550.82€ |
| 250.01.04 | extra cost for mA exit | 168.72€ |

Oxygen PoolTec Panels Spa pH/Rx



Composition / Σύνθεση:

- Oxygen PoolTec Spa Manager
 - MP2-B pump, pH, 1,5l/h
 - MP2-B pump, Rx, 1,5l/h
 - Filter
 - Probes cas
 - Injection Valves

Specifications

POOLTEC SPA pH/REDOX panel series with pH and Redox pumps with on-board instruments. Proportional to the set point established. Possibility to dose acid and basic product (ph) and chlorine for redox.

| CODE | DESCRIPTION | PRICE |
|-----------|---|-----------|
| 250.01.35 | Panel PoolTec pH/Rx +2 Perstaltic pumps MP2-B | 7,004.09€ |

Oxygen PoolTec Panels Spa pH/Cl



Composition / Σύνθεση:

- Oxygen PoolTec Spa Manager
 - MP2-B pump, pH, 1,5l/h
 - MP2-B pump, Cl, 1,5l/h
 - Filter
 - Probes casing
 - Injection Valves

Specifications

POOLTEC SPA pH/Cl panel series with pH and Cl pumps with on-board instruments. Proportional to the set point established. Possibility to dose acid and basic product (ph) and chlorine

| CODE | DESCRIPTION | PRICE |
|-----------|---|-----------|
| 250.01.36 | Panel PoolTec pH/Cl amp +2 Perstaltic pumps MP2-B | 8,784.07€ |

Oxygen PoolTec Panels Home pH/Rx or pH/Cl



Composition / Σύνθεση:

- Oxygen Home PoolTec Manager
 - MP2-HT pump, pH, 6,0l/h
 - MP2-HT pump, Rx/Cl, 6,0l/h
 - Filter
 - Probes casing
 - Injection Valves

Specifications

POOLTEC HOME pH/Rx ή pH/Cl panel series with pH and Redox or Cl pumps with on-board instruments. Proportional to the set point established. Possibility to dose acid and basic product (ph) and chlorine for redox.

| CODE | DESCRIPTION | PRICE |
|-----------|---|-----------|
| 250.01.37 | Panel Home PoolTec pH/Rx +2 Perstaltic pumps MP2-HT | 9,755.00€ |
| 250.01.38 | Panel Home PoolTec pH/Cl amp +2 Perstaltic pumps MP2-HT | 9,755.00€ |

Oxygen PoolTec Panels Home pH/Rx or pH/Cl



Composition / Σύνθεση:

- Oxygen Home PoolTec Manager
 - ME3-C pump, pH, 10,0l/h
 - ME3-C pump, Rx/Cl,10,0l/h
 - Filter
 - Probes casing
 - Injection Valves

Specifications

POOLTEC HOME pH/REDOX or pH/Cl panel series with pH and Cl pumps with on-board instruments. Proportional to the set point established. Possibility to dose acid and basic product (ph) and chlorine

| CODE | DESCRIPTION | PRICE |
|-----------|--|-----------|
| 250.01.39 | Panel Home PoolTec pH/Rx +2 Perstaltic pumps ME3-C | 7,667.23€ |
| 250.01.40 | Panel Home PoolTec pH/Cl amp +2 Perstaltic pumps ME3-C | 9,520.95€ |

Oxygen PoolTec Panels Public pH/Rx



Composition / Σύνθεση:

- Oxygen Public PoolTec Manager
 - ME3-C pump, pH, 10l/h
 - ME3-C pump, Rx, 10l/h
 - Filter
 - Probes casing
 - Injection Valves

Specifications

POOLTEC PUBLIC pH/Rx panel series with pH and Redox solenoid pumps with on-board instruments. Proportional to the set point established. Possibility to dose acid and basic product (ph) and chlorine for redox.

| CODE | DESCRIPTION | PRICE |
|-----------|--|-----------|
| 250.01.41 | Panel Public PoolTec pH/Rx +2 Solenoid pumps ME3-C | 7,900.35€ |

Oxygen PoolTec Panels Public pH/Cl



Composition / Σύνθεση:

- Oxygen Public PoolTec Manager
 - ME3-C pump, pH, 10l/h
 - ME3-C pump, Cl,10l/h
 - Filter
 - Probes casing
 - Injection Valves

Specifications

POOLTEC PUBLIC pH/Cl panel series with pH and Cl solenoid pumps with on-board instruments. Proportional to the set point established. Possibility to dose acid and basic product (ph) and chlorine

| CODE | DESCRIPTION | PRICE |
|-----------|---|-----------|
| 250.01.42 | Panel Public PoolTec pH/ Cl amp +2 Perstaltic pumps ME3-C | 9,731.59€ |



HR UV-C

Advantages:

- Highest UV reflective index on the market equating to supreme efficiency
- E-PTFE reaction chamber is extremely repellent, maintaining UV reflectivity
 - Up to 95% reflection amplifying the exposure of microorganisms to UV
 - No harmful gases or by-products produced
- Neutralises bacteria, viruses, algae and fungi that traditional chemicals cannot
- Optional smart peristaltic dosing system for chlorine/hydrogen peroxide
 - Powerful sterilisation and eliminates the smell of chlorine
 - Average lamp life expectancy: 2 years
 - Equipped with intelligent lamp life indicator
 - 100% Salt and sea water safe

| CODE | 108.11.25 | 108.11.26 | 108.11.27 | 108.11.28 |
|-------------------|------------|------------|--|---|
| DESCRIPTION | 55WATT | 110WATT | 55WATT with lamp life indicator & reset switch | 110WATT with lamp life indicator & reset switch |
| MAX POOL VOLUME | 50 m3 | 100 m3 | 50 m3 | 100 m3 |
| MIN FLOW RATE | 4 m3/h | 4 m3/h | 4 m3/h | 4 m3/h |
| MAX FLOW RATE | 21 m3/h | 42 m3/h | 21 m3/h | 42 m3/h |
| POWER CONSUMPTION | 64W | 128W | 64W | 128W |
| WORKING PRESSURE | 3 bar | 3 bar | 3 bar | 3 bar |
| CONNECTIONS | 2" / Ø63 | 2" / Ø63 | 2" / Ø63 | 2" / Ø63 |
| LAMP | 55W | 110W | 55W | 110W |
| LAMP LIFE | 9000 hours | 9000 hours | 9000 hours | 9000 hours |
| DOSING RATE | 30mj/cm2 | 30mj/cm2 | 30mj/cm2 | 30mj/cm2 |
| PRICE | 1,367.35€ | 2,156.70€ | 1,824.66€ | 2556,34€ |



E-HR UV-C

Advantages:

- Highest UV reflective index on the market equating to supreme efficiency
- E-PTFE reaction chamber is extremely repellent, maintaining UV reflectivity
 - Up to 95% reflection amplifying the exposure of microorganisms to UV
 - No harmful gases or by-products produced
- Neutralises bacteria, viruses, algae and fungi that traditional chemicals cannot
- Optional smart peristaltic dosing system for chlorine/hydrogen peroxide
 - Powerful sterilisation and eliminates the smell of chlorine
 - Average lamp life expectancy: 2 years
 - Equipped with intelligent lamp life indicator
 - 100% Salt and sea water safe

| CODE | 108.11.17 | 108.11.18 | 108.11.19 | 108.11.20 |
|-------------------|--|---|--|---|
| DESCRIPTION | 55WATT with lamp life indicator & reset switch | 110WATT with lamp life indicator & reset switch | 55WATT with lamp life indicator & reset switch | 110WATT with lamp life indicator & reset switch |
| FEATURES | Analogue Lamp Life Indicator | Analogue Lamp Life Indicator | Digital Lamp Life Indicator | Digital Lamp Life Indicator |
| MAX POOL VOLUME | 50 m3 | 100 m3 | 50 m3 | 100 m3 |
| MIN FLOW RATE | 4 m3/h | 4 m3/h | 4 m3/h | 4 m3/h |
| MAX FLOW RATE | 21 m3/h | 42 m3/h | 21 m3/h | 42 m3/h |
| POWER CONSUMPTION | 64W | 128W | 64W | 128W |
| WORKING PRESSURE | 3 bar | 3 bar | 3 bar | 3 bar |
| CONNECTIONS | 2" / Ø63 | 2" / Ø63 | 2" / Ø63 | 2" / Ø63 |
| LAMP | 55W | 110W | 55W | 110W |
| LAMP LIFE | 9000 hours | 9000 hours | 9000 hours | 9000 hours |
| DOSING RATE | 30mj/cm2 | 30mj/cm2 | 30mj/cm2 | 30mj/cm2 |
| PRICE | 2,373.42€ | 3,379.50€ | 3,333.77€ | 4,385.57€ |

E-Quantum Photocatalytic Oxydiser



The photocatalytic oxydiser is the cutting edge technology in water sterilization. The chamber is dipped in to a special liquid wich creates nanocrystals. When UV light strikes the crystals the photocatalytic reaction is generated to destroy all pathogenic micro-organisms



Advantages:

- Photocatalytic TiO₂/Mo oxidiser and clarifier
- Combined photocatalytic, hydroxyl radical and UV technology
- Reduces the need for chemicals in the pool
- Keeps your family safe from dangerous micro-organisms such as cryptosporidium, adenoviruses and naegleria fowleri
- Optional smart peristaltic dosing system for chlorine/hydrogen peroxide
- Powerful sterilisation and eliminates the smell of chlorine
- 100% Salt and sea water safe

| CODE | 108.11.21 | 108.11.22 | 108.11.23 | 108.11.24 |
|-------------------|--|--|---|---|
| FEATURES | 55WATT with Analogue Lamp indicator, Reset Switch, Flow Switch | 55WATT with Lamp Life Countdown, Intelligent Dosing, Reset Switch, Flow Switch | 110WATT with Analogue Lamp indicator, Reset Switch, Flow Switch | 110WATT with Lamp Life Countdown, Intelligent Dosing, Reset Switch, Flow Switch |
| MAX POOL VOLUME | 65 m ³ | 65 m ³ | 130 m ³ | 130 m ³ |
| MIN FLOW RATE | 4 m ³ /h | 4 m ³ /h | 4 m ³ /h | 4 m ³ /h |
| MAX FLOW RATE | 14 m ³ /h | 14 m ³ /h | 28 m ³ /h | 28 m ³ /h |
| POWER CONSUMPTION | 64W | 64W | 128W | 128W |
| WORKING PRESSURE | 3 bar | 3 bar | 3 bar | 3 bar |
| CONNECTIONS | 2" / Ø63 | 2" / Ø63 | 2" / Ø63 | 2" / Ø63 |
| LAMP | 55W | 55W | 110W | 110W |
| LAMP LIFE | 14000 hours | 14000 hours | 14000 hours | 14000 hours |
| DOSING RATE | 30mj/cm ² | 30mj/cm ² | 30mj/cm ² | 30mj/cm ² |
| PRICE | 3,516.69€ | 4,888.62€ | 4,659.95€ | 6,031.88€ |

Pro pH / Rx Probes



- LENGHT PROBE 125 mm
- Version: PRO-PH, PRO-REDOX
- Probe: combined
- Range: 0÷14 pH, ±2000mv
 - Offset ± 20 mV
- Pressure - T°: max 2 bar / 50 °C
 - Connection: BNC
 - Body: Epoxy Ø12
 - Cable: Coaxial

| CODE | DESCRIPTION | PRICE |
|------------|-------------------------|---------|
| 108.05.168 | Pro-pH Probe, 1m cable | 269.15€ |
| 108.05.169 | Pro-pH Probe, 5m cable | 293.32€ |
| 108.05.170 | Pro-pH Probe, 10m cable | 303.66€ |
| 108.05.171 | Pro-Rx Probe, 1m cable | 269.15€ |
| 108.05.172 | Pro-Rx Probe, 5m cable | 293.32€ |
| 108.05.173 | Pro-Rx Probe, 10m cable | 303.66€ |

Amperometric Cell

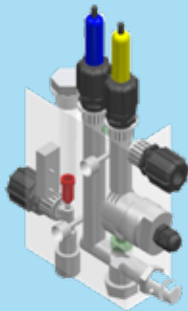

Amperometric cell with electrodes of platinum and copper, for the measurement of residual chlorine. Supplied already mounted on a probe holder complete with flow regulator and prepared for flow sensor housings electrode and temperature sensor. Measuring range from 0.05 to 5.00ppm. Self cleaning by means of glass spheres Copper and platinum electrode operating flow rate 40 l/h. Max pressure 3 bar 4x6 or 8x12 water connections. Dimensions 210x190x50 mm

| CODE | DESCRIPTION | PROBES | PRICE |
|------------|--------------------------|--------|-----------|
| 108.05.174 | PRO CG-CL3, fitting 4X6 | 0 | 2,726.08€ |
| 108.05.175 | PRO CG-CL3, fitting 4X6 | 1 | 2,726.08€ |
| 108.05.176 | PRO CG-CL3, fitting 4X6 | 2 | 2,805.46€ |
| 108.05.177 | PRO CG-CL3, fitting 8X12 | 0 | 2,757.15€ |
| 108.05.178 | PRO CG-CL3, fitting 8X12 | 1 | 2,757.15€ |
| 108.05.179 | PRO CG-CL3, fitting 8X12 | 2 | 2,829.62€ |

Buffer Solutions



**Διάλυμα ρύθμισης
σε συσκευασία 50ml**

**Buffer solution
in 50ml container**

| CODE | DESCRIPTION | PRICE |
|------------|-------------|--------|
| 108.05.180 | pH 4 | 23.13€ |
| 108.05.181 | pH 7 | 23.13€ |
| 108.05.182 | pH 9 | 23.13€ |
| 108.05.183 | Redox 468mv | 34.51€ |
| 108.05.184 | Redox 650mv | 34.51€ |
| 108.05.185 | 12880 µS/CM | 34.51€ |
| 108.05.186 | 1413 µS/CM | 34.51€ |

Chemical Tanks

Strong and durable dosing tank moulded in virgin MDPE ideal for chemical dosing systems. All of our liquid storage tanks are supplied complete with tight fitting screw cap. The heavy duty plastic storage tanks are suitable for containing a wide range of chemicals and liquids including a vast number of chlorides, fluorides, hydroxides, nitrates, sulphates, carbonates, chlorates as well common acids such as nitric acid, citric acid and hydrochloric acid.



| CODE | DESCRIPTION | PRICE |
|-----------|-----------------|-----------|
| 207.08.14 | 100 litres tank | 690.14€ |
| 207.08.15 | 150 litres tank | 870.91€ |
| 207.08.16 | 200 litres tank | 1,035.22€ |



Pool Finishing

OXYGON⁺

SOPREMAPOOL ONE OXYGON⁺



SOPREMAPOOL ONE
Light Blue 120.03.34
35,85€/m²



SOPREMAPOOL ONE
Azure Blue 120.03.35
35,85€/m²



SOPREMAPOOL ONE
Sapphire Blue 120.03.36
35,85€/m²

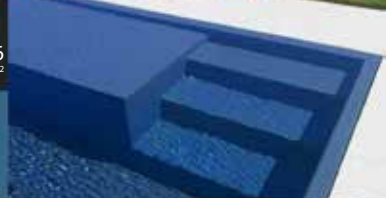

SOPREMAPOOL ONE
Caribbean Green 120.03.37
35,85€/m²



SOPREMAPOOL ONE
Natural Green 120.03.38
35,85€/m²



SOPREMAPOOL ONE
Sand 120.03.39
35,85€/m²



SOPREMAPOOL ONE
White 120.03.40
35,85€/m²



SOPREMAPOOL ONE
Light Grey 120.03.41
35,85€/m²



SOPREMAPOOL ONE
Medium Grey 120.03.42
35,85€/m²



SOPREMAPOOL ONE
Basalt Grey 120.03.43
35,85€/m²



150/100
REINFORCED MEMBRANE
1.5 mm reinforced PVC
membranes manufactured
by cast process.

SopremaPool One provides
high resistance to
weathering, UV rays,
and microorganisms.

DIMENSIONS
Roll of 1,65m x 25,00m
(41,25m²)

GRIP (non-slip version)
All colours are available in
the non-slip version.
Roll of 1,65m x 10,00m
(16,50m²)

- Flexible
- Smooth
- Exclusive varnish integrated in all four layers
- Intense and multiple colours

WARRANTY

10 years

Waterproofing

SOPREMAPOOL PREMIUM OXYGON⁺



150/100 REINFORCED MEMBRANE
1.5 mm reinforced PVC membranes manufactured by cast process. SopremaPool Premium features a varnished coating for enhanced durability and resistance to colour fading, chlorine, stains, microorganisms, and UV rays. SopremaPool One provides high resistance to weathering, UV rays, and microorganisms.

DIMENSIONS
Roll of 1,65m x 25,00m (41,25m²)

- GRIP (non-slip version)**
All colours are available in the non-slip version.
Roll of 1,65m x 10,00m (16,50m²)
- Flexible
 - Smooth
 - Exclusive varnish integrated in all four layers
 - Intense and multiple colours

SOPREMAPOOL PREMIUM
Light Blue 120.03.44
41,51€/m²

SOPREMAPOOL PREMIUM
Azure Blue 120.03.45
41,51€/m²

SOPREMAPOOL PREMIUM
Dark Blue 120.03.46
41,51€/m²

SOPREMAPOOL PREMIUM
Wild Musk 120.03.47
41,51€/m²

SOPREMAPOOL PREMIUM
Sand 120.03.48
41,51€/m²

SOPREMAPOOL PREMIUM
White 120.03.49
41,51€/m²

SOPREMAPOOL PREMIUM
Light Grey 120.03.50
41,51€/m²

SOPREMAPOOL PREMIUM
Medium Grey 120.03.51
41,51€/m²

SOPREMAPOOL PREMIUM
Basalt Grey 120.03.52
43,72€/m²

SOPREMAPOOL PREMIUM
Black 120.03.53
43,72€/m²



WARRANTY
12 years
Waterproofing

WARRANTY
3 years
Stains*

*Stains caused by bacteria

SOPREMAPOOL DESIGN OXYGON⁺



SOPREMAPOOL DESIGN
Mineral Amber 120.03.89
49,17€/m²

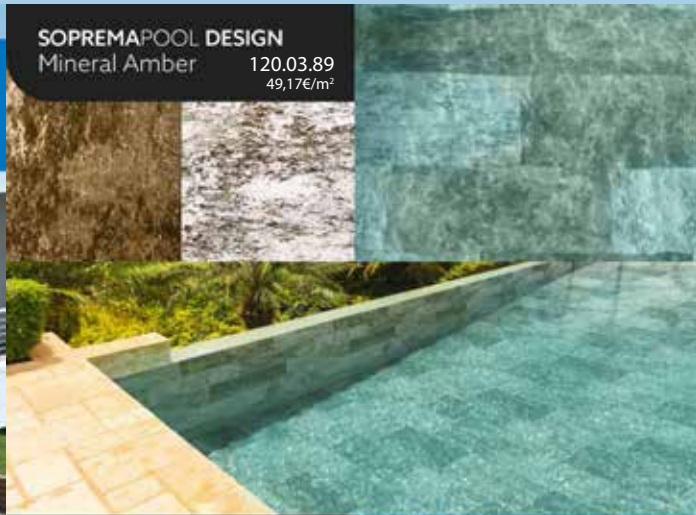

SOPREMAPOOL DESIGN
Mineral Sapphire 120.03.90
49,17€/m²

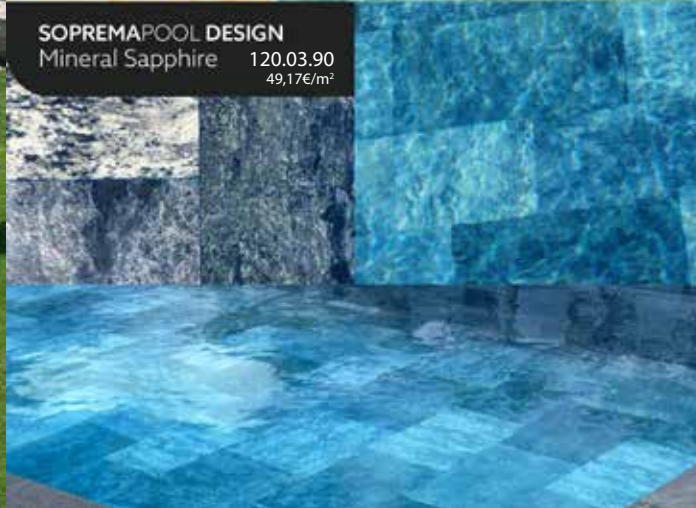

SOPREMAPOOL DESIGN
Mineral Jade 120.03.90
49,17€/m²



SOPREMAPOOL DESIGN
Marbella Blue 120.03.54
48,94€/m²



150/100
REINFORCED MEMBRANE
1.5 mm reinforced PVC
membranes manufactured
by cast process.

SopremaPool Design
features a varnished coating
for enhanced durability and
resistance to colour fading,
chlorine, stains, microorgan-
isms, and UV rays.

DIMENSIONS
Roll of 1,65m x 25,00m
(41,25m²)

GRIP (non-slip version)
All colours are available in
the non-slip version.
Roll of 1,65m x 10,00m
(16,50m²)

- Flexible
- Smooth
- Exclusive varnish integrated in all four layers
- Varnish coating
- Exclusive designs
- Multiple designs



WARRANTY
12 years
Waterproofing

WARRANTY
3 years
Stains*

* Stains caused by bacteria

SOPREMAPOOL DESIGN

Marbella Grey

120.03.55
48,94€/m²



SOPREMAPOOL DESIGN

Sky Blue

120.03.59
49,17€/m²

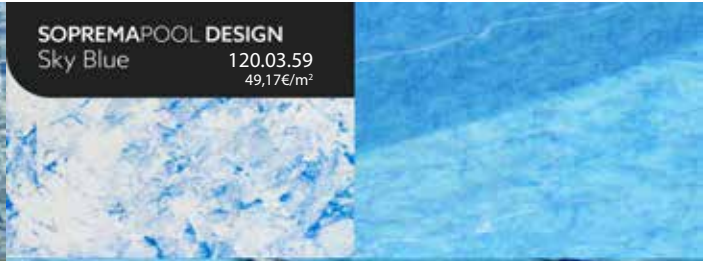

SOPREMAPOOL DESIGN

Marbella Black

120.03.56
48,94€/m²



SOPREMAPOOL DESIGN

Pearl Black

120.03.60
49,17€/m²



SOPREMAPOOL DESIGN

Mosaic Blue

120.03.57
48,94€/m²



SOPREMAPOOL DESIGN

Bali

120.03.58
49,17€/m²

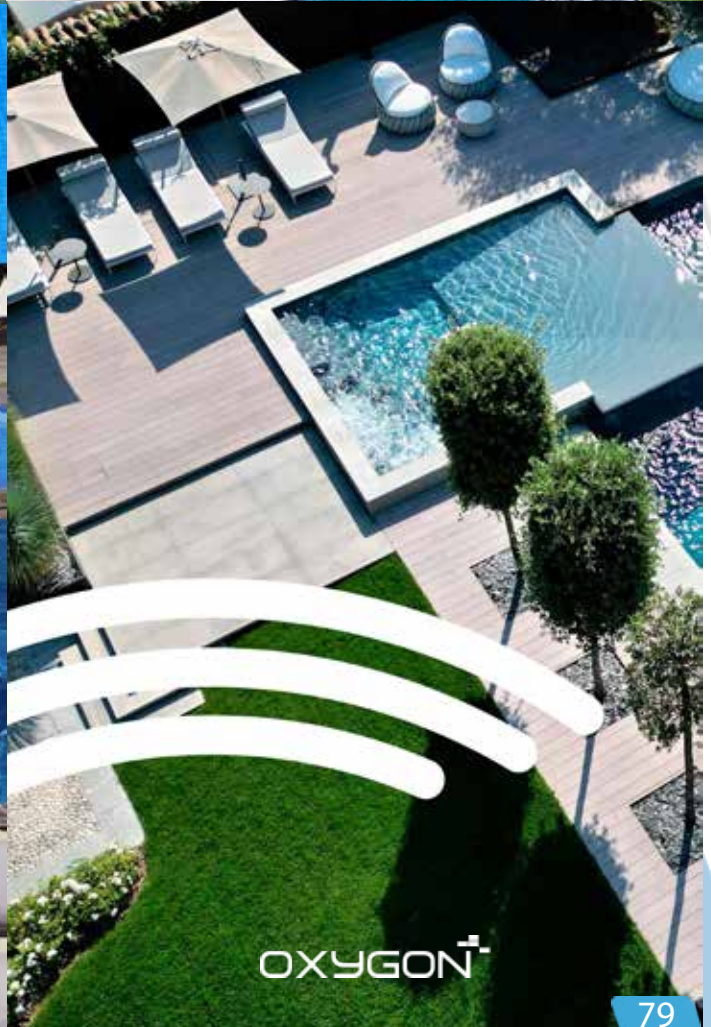
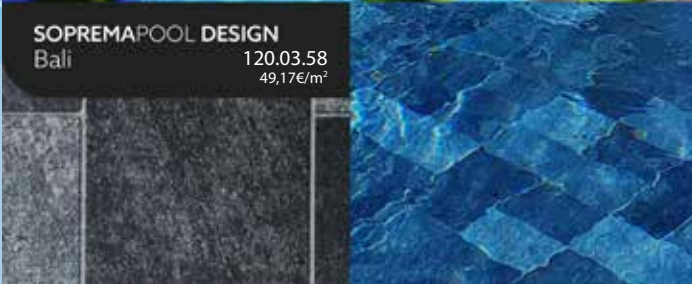

SOPREMAPOOL FEELING
OXYGON⁺

SOPREMAPOOL FEELING
Sand 120.03.61
47,92€/m²

SOPREMAPOOL FEELING
Azure blue 120.03.62
47,92€/m²

SOPREMAPOOL FEELING
White 120.03.63
47,92€/m²

SOPREMAPOOL FEELING
Medium Grey 120.03.64
47,92€/m²

SOPREMAPOOL FEELING
Basalt Grey 120.03.65
49,27€/m²



150/100
REINFORCED MEMBRANE
1.5 mm reinforced PVC
membranes manufactured
by cast process with an
embossed, non-slip finish.

SopremaPool Feeling
provides high resistance to
weathering, UV rays, and mi-
croorganisms while offering
a soft, comfortable touch.

DIMENSIONS
Roll of 1,65m x 25,00m
(41,25m²)



Non-slip
embossing

WARRANTY

10 years

Waterproofing

- Flexible
- Smooth
- Easy and quick installation.
- Sensory experience.
- Non-slip embossing



SOPREMAPOOL 3D OXYGON⁺

SOPREMAPOOL 3D Mineral Amber

120.03.86
74,51€/m²



SOPREMAPOOL 3D Mineral Sapphire

120.03.87
74,51€/m²



SOPREMAPOOL 3D Mineral Jade

120.03.88
74,51€/m²

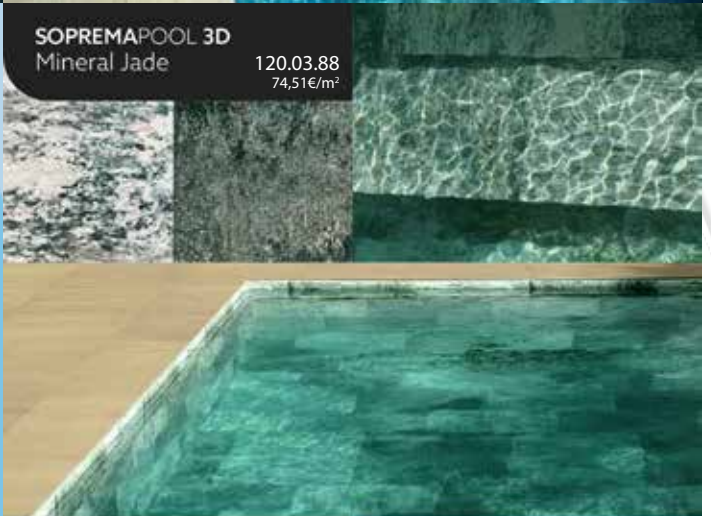

SOPREMAPOOL 3D Ocean

120.03.71
74,51€/m²



180/100
REINFORCED MEMBRANE
1.8 mm reinforced PVC membranes manufactured by a cast process, featuring an elegant embossed, non-slip finish for added style and safety. The varnished coating enhances durability and provides resistance to colour fading, chlorine, stains, micro-organisms, and UV rays. The embossed finish is not only aesthetically pleasing but also ensures a comfortable and non-slip surface. SopremaPool 3D membranes mimic the appearance and texture of natural materials, seamlessly combining beauty with functionality. Their unique embossed motifs bring an added layer of sophistication while maintaining all the core benefits of reinforced PVC membranes: easy and quick installation, as well as high protective and waterproofing performance.
DIMENSIONS Roll of 1,65m x 25,00m (41,25m²)



- Attractive and stylish
- Easy and quick installation
 - Sensory experience
 - Varnish coating
- Exclusive and multiple designs
 - Non-slip embossing

WARRANTY

12 years

Waterproofing

WARRANTY

3 years

Stains

*Stains caused by bacteria

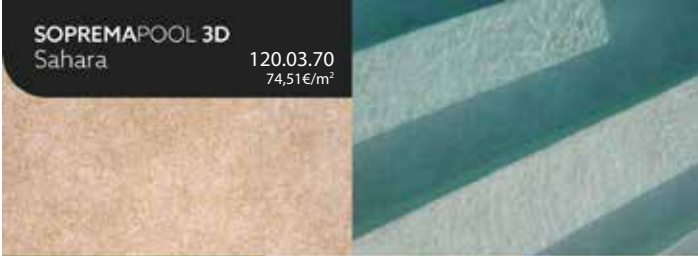

SOPREMAPOOL 3D
Sahara

120.03.70
74,51€/m²

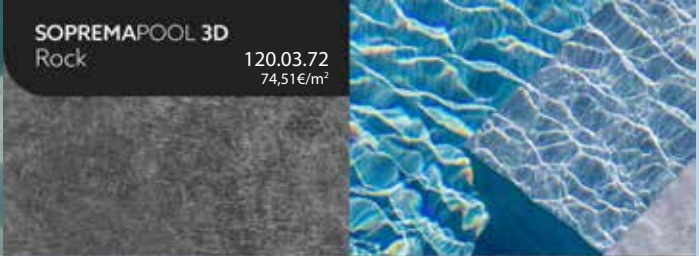

SOPREMAPOOL 3D
Rock

120.03.72
74,51€/m²



SOPREMAPOOL 3D
Sensitive white

120.03.67
74,51€/m²

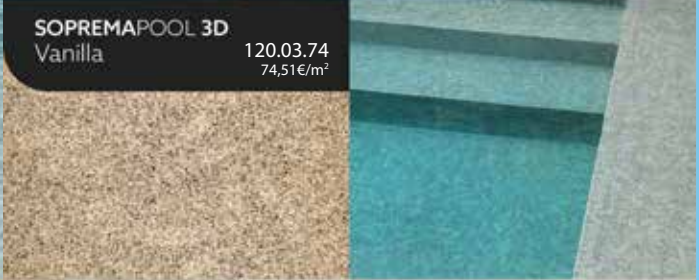

SOPREMAPOOL 3D
Vanilla

120.03.74
74,51€/m²

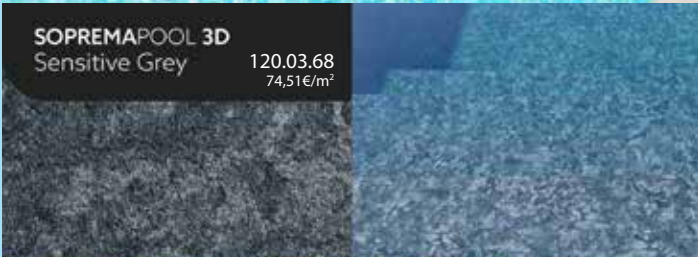

SOPREMAPOOL 3D
Sensitive Grey

120.03.68
74,51€/m²

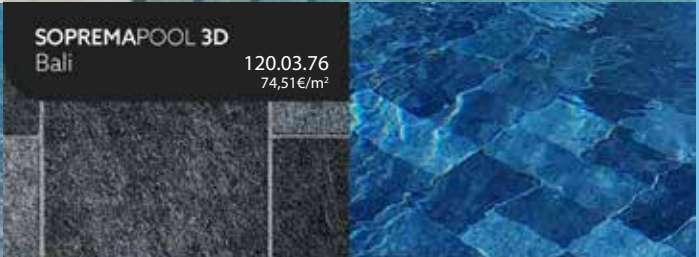

SOPREMAPOOL 3D
Bali

120.03.76
74,51€/m²

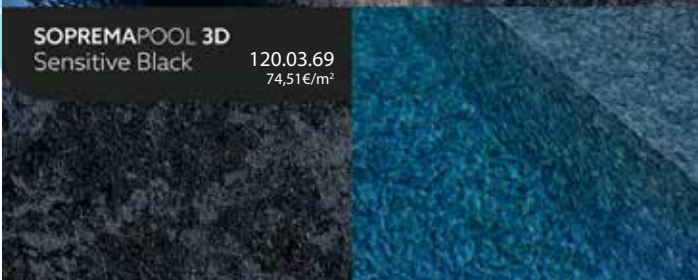

SOPREMAPOOL 3D
Sensitive Black

120.03.69
74,51€/m²

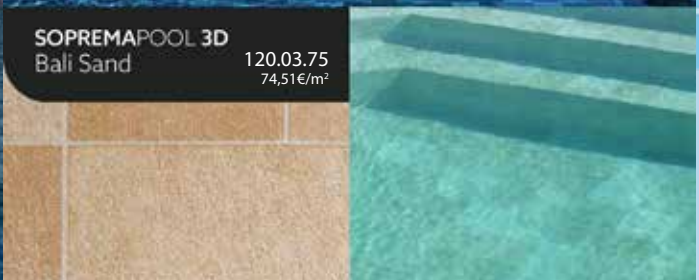

SOPREMAPOOL 3D
Bali Sand

120.03.75
74,51€/m²





SOPREMAPOOL 3D
Bali XL

120.03.77
74,51€/m²



SOPREMAPOOL 3D
White Wood

120.03.79
74,51€/m²



SOPREMAPOOL 3D
Wood

120.03.78
74,51€/m²



SOPREMAPOOL 3D
Infinite

120.03.73
74,51€/m²

OXYGON



Profile to anchor the reinforced membrane, especially suitable for new-build pools.

| CODE | DESCRIPTION | PRICE / pcs |
|-----------|---------------------------------------|-------------|
| 107.15.32 | aluminium profile For Liner 2mX-0,05m | 47.85€ |



Cord to weld the edge of the reinforced membrane to attach it to the profile. Dimensions: 25 m x 9 mm (every unit).

| CODE | DESCRIPTION | PRICE / pack |
|------------|------------------------------|--------------|
| 107.15.299 | Bandelettes 9mm-25m PVC Roll | 98.70€ |



The PVC border is used to block the anchorage of the reinforced membrane and maintain the tension. It also allows a better aesthetic finish.

| CODE | DESCRIPTION | PRICE / lin.m. |
|-----------|----------------------------------|----------------|
| 107.15.28 | Bordino PVC White 30m/Roll | 8.70€ |
| 107.15.27 | Bordino PVC Medium Grey 30m/Roll | 8.70€ |
| 107.15.39 | Bordino PVC Dark Grey 30m/Roll | 8.70€ |
| 107.15.38 | Bordino PVC Light Blue 30m/Roll | 8.70€ |
| 107.15.37 | Bordino PVC Sand 30m/Roll | 8.70€ |



Expansion nails for fixing the SOPREMAPOOL reinforced membrane to the support. Dimensions: 4.8ø x 25 mm

| CODE | DESCRIPTION | PRICE / pcs |
|-----------|---------------------------|-------------|
| 107.15.36 | Aluminium Expansion Nails | 2.97€ |



Cold contact glue for single and double gluing the reinforced membrane to the pool structure at specific points.

| CODE | DESCRIPTION | PRICE / cont. |
|-----------|-------------------------------------|---------------|
| 107.15.31 | Alsán Bond Pool 410, (5l container) | 353.43€ |



Profile to fix the reinforced membrane in new-build or refurbished pools where there is a raised coping. Dimensions: 2 m x 0.05 m x 0.05 m

| CODE | DESCRIPTION | PRICE / pcs |
|-----------|--|-------------|
| 107.15.90 | Angle PVC / Metal Strip, 2mX-0,05mX0,05m | 95.00€ |



Liquid PVC for optimum cold sealing of welds made on membranes reinforced with SOPREMAPOOL.

| CODE | DESCRIPTION | PRICE / pcs |
|------------------|------------------|-------------|
| depending colour | Liquid PVC, 1lit | 130.00€ |

Profile Type A

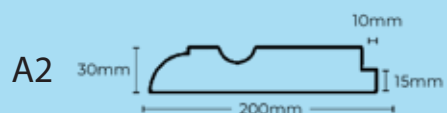
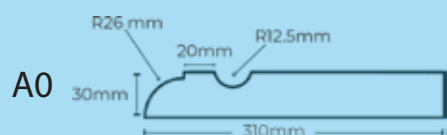
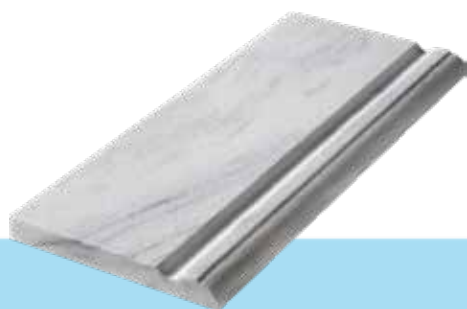

| CODE | MARBLE | LENGTH mm | WIDTH mm | THICKNESS mm | PRICE / lin. meter |
|-----------|-------------|--------------|-------------|-----------------|-----------------------|
| 430.40.01 | Kavala | 610 | 260-310 | 30 | 182,16 € |
| 430.40.02 | | 610 | 210-250 | 30 | 153,12 € |
| 430.40.03 | | 610 | 200 | 30 | 121,44 € |
| 430.40.04 | East Grey | 610 | 260-310 | 30 | 232,32 € |
| 430.40.05 | | 610 | 210-250 | 30 | 192,72 € |
| 430.40.06 | | 610 | 200 | 30 | 155,76 € |
| 430.40.07 | Sunny | 610 | 260-310 | 30 | 150,48 € |
| 430.40.08 | | 610 | 210-250 | 30 | 126,72 € |
| 430.40.09 | | 610 | 200 | 30 | 100,32 € |
| 430.40.10 | California | 610 | 260-310 | 30 | 250,80 € |
| 430.40.11 | | 610 | 210-250 | 30 | 208,56 € |
| 430.40.12 | | 610 | 200 | 30 | 168,96 € |
| 430.40.13 | Aliveri | 610 | 260-310 | 30 | 173,05 € |
| 430.40.14 | | 610 | 210-250 | 30 | 145,73 € |
| 430.40.15 | | 610 | 200 | 30 | 115,37 € |
| 430.40.16 | Vratsa | 610 | 260-310 | 30 | 250,80 € |
| 430.40.17 | | 610 | 210-250 | 30 | 208,56 € |
| 430.40.18 | | 610 | 200 | 30 | 168,96 € |
| 430.40.19 | Sinai Pearl | 610 | 260-310 | 30 | 184,80 € |
| 430.40.20 | | 610 | 210-250 | 30 | 153,12 € |
| 430.40.21 | | 610 | 200 | 30 | 124,08 € |

Profile Type B

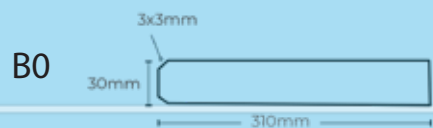
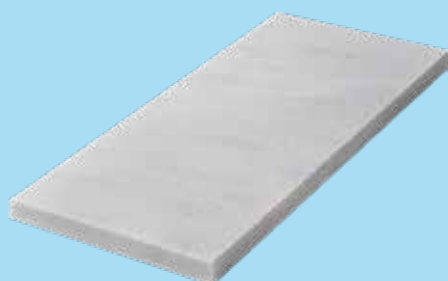

| CODE | MARBLE | LENGTH mm | WIDTH mm | THICKNESS mm | PRICE / lin. meter |
|-----------|-------------|--------------|-------------|-----------------|-----------------------|
| 430.40.22 | Kavala | 610 | 260-310 | 30 | 174,24 € |
| 430.40.23 | | 610 | 210-250 | 30 | 145,20 € |
| 430.40.24 | | 610 | 200 | 30 | 113,52 € |
| 430.40.25 | East Grey | 610 | 260-310 | 30 | 224,40 € |
| 430.40.26 | | 610 | 210-250 | 30 | 184,80 € |
| 430.40.27 | | 610 | 200 | 30 | 147,84 € |
| 430.40.28 | Sunny | 610 | 260-310 | 30 | 142,56 € |
| 430.40.29 | | 610 | 210-250 | 30 | 118,80 € |
| 430.40.30 | | 610 | 200 | 30 | 92,40 € |
| 430.40.31 | California | 610 | 260-310 | 30 | 242,88 € |
| 430.40.32 | | 610 | 210-250 | 30 | 200,64 € |
| 430.40.33 | | 610 | 200 | 30 | 161,04 € |
| 430.40.34 | Aliveri | 610 | 260-310 | 30 | 163,94 € |
| 430.40.35 | | 610 | 210-250 | 30 | 136,62 € |
| 430.40.36 | | 610 | 200 | 30 | 106,26 € |
| 430.40.37 | Vratsa | 610 | 260-310 | 30 | 242,88 € |
| 430.40.38 | | 610 | 210-250 | 30 | 200,64 € |
| 430.40.39 | | 610 | 200 | 30 | 161,04 € |
| 430.40.40 | Sinai Pearl | 610 | 260-310 | 30 | 176,88 € |
| 430.40.41 | | 610 | 210-250 | 30 | 145,20 € |
| 430.40.42 | | 610 | 200 | 30 | 116,16 € |

Profile Type C

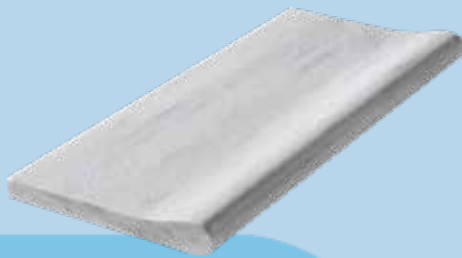

C0

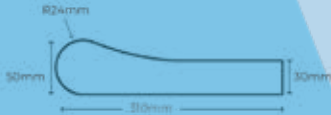

C1

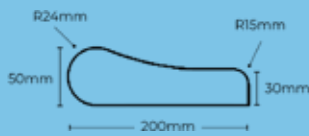

C2

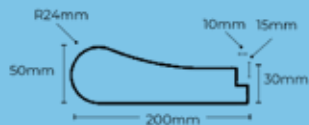

| CODE | MARBLE | LENGTH mm | WIDTH mm | THICKNESS mm | PRICE / lin. meter |
|------------|-------------|--------------|-------------|-----------------|-----------------------|
| 430.40.43 | Kavala | 610 | 260-310 | 30/50 | 377,52 € |
| 430.40.44 | | 610 | 210-250 | 30/50 | 314,16 € |
| | | | | | 0,00 € |
| 430.40.46 | East Grey | 610 | 260-310 | 30/50 | 475,20 € |
| 430.40.47 | | 610 | 210-250 | 30/50 | 396,00 € |
| | | | | | 0,00 € |
| 430.40.49 | Sunny | 610 | 260-310 | 30/50 | 316,80 € |
| 430.40.50 | | 610 | 210-250 | 30/50 | 264,00 € |
| | | | | | 0,00 € |
| 430.40.52 | California | 610 | 260-310 | 30/50 | 549,12 € |
| 430.40.53 | | 610 | 210-250 | 30/50 | 456,72 € |
| | | | | | 0,00 € |
| 430.40.55 | Aliveri | 610 | 260-310 | 30/50 | 364,32 € |
| 430.40.56 | | 610 | 210-250 | 30/50 | 303,60 € |
| | | | | | 0,00 € |
| 430.40.58 | Vratsa | 610 | 260-310 | 30/50 | 549,12 € |
| 430.40.59 | | 610 | 210-250 | 30/50 | 456,72 € |
| | | | | | 0,00 € |
| 430.40.243 | Sinai Pearl | 610 | 260-310 | 30/50 | 382,80 € |
| 430.40.244 | | 610 | 210-250 | 30/50 | 316,80 € |
| | | | | | 0,00 € |

Profile Type D



D0

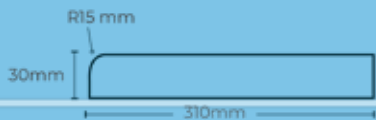

D1

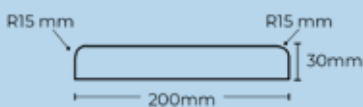

D2

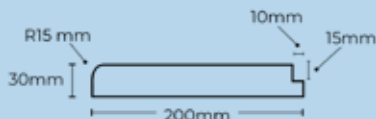

| CODE | MARBLE | LENGTH mm | WIDTH mm | THICKNESS mm | PRICE / lin. meter |
|-----------|-------------|--------------|-------------|-----------------|-----------------------|
| 430.40.61 | Kavala | 610 | 260-310 | 30 | 182,16 € |
| 430.40.62 | | 610 | 210-250 | 30 | 153,12 € |
| 430.40.63 | | 610 | 200 | 30 | 121,44 € |
| 430.40.64 | East Grey | 610 | 260-310 | 30 | 232,32 € |
| 430.40.65 | | 610 | 210-250 | 30 | 192,72 € |
| 430.40.66 | | 610 | 200 | 30 | 155,76 € |
| 430.40.67 | Sunny | 610 | 260-310 | 30 | 150,48 € |
| 430.40.68 | | 610 | 210-250 | 30 | 126,72 € |
| 430.40.69 | | 610 | 200 | 30 | 100,32 € |
| 430.40.70 | California | 610 | 260-310 | 30 | 250,80 € |
| 430.40.71 | | 610 | 210-250 | 30 | 208,56 € |
| 430.40.72 | | 610 | 200 | 30 | 168,96 € |
| 430.40.73 | Aliveri | 610 | 260-310 | 30 | 173,05 € |
| 430.40.74 | | 610 | 210-250 | 30 | 145,73 € |
| 430.40.75 | | 610 | 200 | 30 | 115,37 € |
| 430.40.76 | Vratsa | 610 | 260-310 | 30 | 250,80 € |
| 430.40.77 | | 610 | 210-250 | 30 | 208,56 € |
| 430.40.78 | | 610 | 200 | 30 | 168,96 € |
| 430.40.79 | Sinai Pearl | 610 | 260-310 | 30 | 184,80 € |
| 430.40.80 | | 610 | 210-250 | 30 | 153,12 € |
| 430.40.81 | | 610 | 200 | 30 | 124,08 € |

Profile Type E



E0

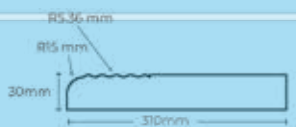

E1

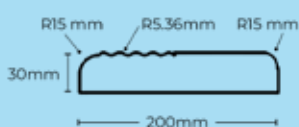

E2

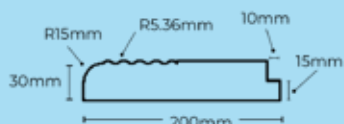

| CODE | MARBLE | LENGTH mm | WIDTH mm | THICKNESS mm | PRICE / lin. meter |
|------------|-------------|-----------|----------|--------------|--------------------|
| 430.40.82 | Kavala | 610 | 260-310 | 30 | 182,16 € |
| 430.40.83 | | 610 | 210-250 | 30 | 153,12 € |
| 430.40.84 | | 610 | 200 | 30 | 121,44 € |
| 430.40.85 | East Grey | 610 | 260-310 | 30 | 232,32 € |
| 430.40.86 | | 610 | 210-250 | 30 | 192,72 € |
| 430.40.87 | | 610 | 200 | 30 | 155,76 € |
| 430.40.88 | Sunny | 610 | 260-310 | 30 | 150,48 € |
| 430.40.89 | | 610 | 210-250 | 30 | 126,72 € |
| 430.40.90 | | 610 | 200 | 30 | 100,32 € |
| 430.40.91 | California | 610 | 260-310 | 30 | 250,80 € |
| 430.40.92 | | 610 | 210-250 | 30 | 208,56 € |
| 430.40.93 | | 610 | 200 | 30 | 168,96 € |
| 430.40.94 | Aliveri | 610 | 260-310 | 30 | 173,05 € |
| 430.40.95 | | 610 | 210-250 | 30 | 145,73 € |
| 430.40.96 | | 610 | 200 | 30 | 115,37 € |
| 430.40.97 | Vratsa | 610 | 260-310 | 30 | 250,80 € |
| 430.40.98 | | 610 | 210-250 | 30 | 208,56 € |
| 430.40.99 | | 610 | 200 | 30 | 168,96 € |
| 430.40.100 | Sinai Pearl | 610 | 260-310 | 30 | 184,80 € |
| 430.40.101 | | 610 | 210-250 | 30 | 153,12 € |
| 430.40.102 | | 610 | 200 | 30 | 124,08 € |

Profile Type F

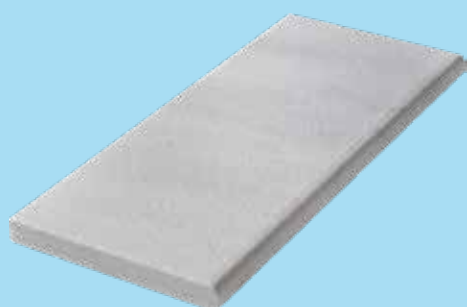

F0

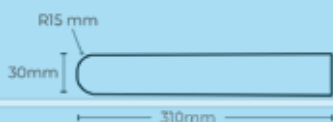

F1

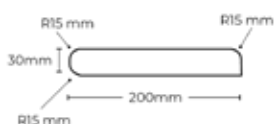

F2

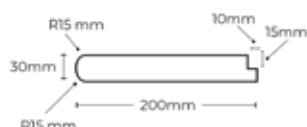

| CODE | MARBLE | LENGTH mm | WIDTH mm | THICKNESS mm | PRICE / lin. meter |
|------------|-------------|-----------|----------|--------------|--------------------|
| 430.40.103 | Kavala | 610 | 260-310 | 30 | 200,64 € |
| 430.40.104 | | 610 | 210-250 | 30 | 171,60 € |
| 430.40.105 | | 610 | 200 | 30 | 139,92 € |
| 430.40.106 | East Grey | 610 | 260-310 | 30 | 250,80 € |
| 430.40.107 | | 610 | 210-250 | 30 | 211,20 € |
| 430.40.108 | | 610 | 200 | 30 | 174,24 € |
| 430.40.109 | Sunny | 610 | 260-310 | 30 | 168,96 € |
| 430.40.110 | | 610 | 210-250 | 30 | 145,20 € |
| 430.40.111 | | 610 | 200 | 30 | 118,80 € |
| 430.40.112 | California | 610 | 260-310 | 30 | 269,28 € |
| 430.40.113 | | 610 | 210-250 | 30 | 227,04 € |
| 430.40.114 | | 610 | 200 | 30 | 187,44 € |
| 430.40.115 | Aliveri | 610 | 260-310 | 30 | 194,30 € |
| 430.40.116 | | 610 | 210-250 | 30 | 166,98 € |
| 430.40.117 | | 610 | 200 | 30 | 136,62 € |
| 430.40.118 | Vratsa | 610 | 260-310 | 30 | 269,28 € |
| 430.40.119 | | 610 | 210-250 | 30 | 227,04 € |
| 430.40.120 | | 610 | 200 | 30 | 187,44 € |
| 430.40.121 | Sinai Pearl | 610 | 260-310 | 30 | 203,28 € |
| 430.40.122 | | 610 | 210-250 | 30 | 171,60 € |
| 430.40.123 | | 610 | 200 | 30 | 142,56 € |

Profile Type G

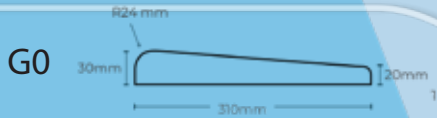
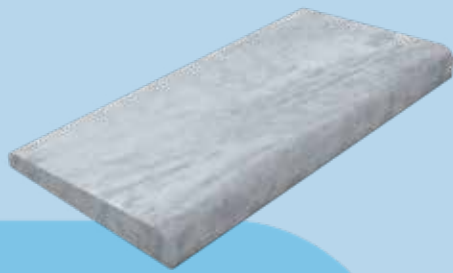

| CODE | MARBLE | LENGTH mm | WIDTH mm | THICKNESS mm | PRICE / lin. meter |
|------------|-------------|-----------|----------|--------------|--------------------|
| 430.40.243 | Kavala | 610 | 260-310 | 30 | 250,80 € |
| 430.40.244 | | 610 | 210-250 | 30 | 216,48 € |
| 430.40.245 | | 610 | 200 | 30 | 176,88 € |
| 430.40.246 | East Grey | 610 | 260-310 | 30 | 314,16 € |
| 430.40.247 | | 610 | 210-250 | 30 | 264,00 € |
| 430.40.248 | | 610 | 200 | 30 | 219,12 € |
| 430.40.249 | Sunny | 610 | 260-310 | 30 | 211,20 € |
| 430.40.250 | | 610 | 210-250 | 30 | 182,16 € |
| 430.40.251 | | 610 | 200 | 30 | 150,48 € |
| 430.40.252 | California | 610 | 260-310 | 30 | 337,92 € |
| 430.40.253 | | 610 | 210-250 | 30 | 285,12 € |
| 430.40.254 | | 610 | 200 | 30 | 234,96 € |
| 430.40.255 | Aliveri | 610 | 260-310 | 30 | 242,88 € |
| 430.40.256 | | 610 | 210-250 | 30 | 209,48 € |
| 430.40.257 | | 610 | 200 | 30 | 173,05 € |
| 430.40.258 | Vratsa | 610 | 260-310 | 30 | 337,92 € |
| 430.40.259 | | 610 | 210-250 | 30 | 285,12 € |
| 430.40.260 | | 610 | 200 | 30 | 234,96 € |
| 430.40.261 | Sinai Pearl | 610 | 260-310 | 30 | 256,08 € |
| 430.40.262 | | 610 | 210-250 | 30 | 216,48 € |
| 430.40.263 | | 610 | 200 | 30 | 179,52 € |

Infinity

New for 2026

Marble Coping Pieces for Waterfalls & Infinity Pools

For 2026, Oxygon proudly introduces a brand-new range of special marble coping pieces, designed specifically for waterfalls and infinity pool applications. These elements are created to deliver a seamless water flow, refined aesthetics, and long-term durability—transforming pools into true architectural statements.

Crafted from premium Greek marble, these coping pieces stand out through their exceptional natural beauty, strength, and resistance to time and water. Greek marble is internationally renowned for its purity, elegant veining, and superior performance in demanding outdoor environments, making it an ideal choice for luxury pool finishes.

Backed by Oxygon's 25 years of experience in the pool, spa, and water treatment industry, this new collection reflects our continuous commitment to innovation and high-quality design. Every piece has been carefully developed to meet the needs of modern pool projects, combining precise geometry with flawless water overflow effects for both private and commercial installations.

- Designed for waterfalls & infinity pools
- Made from high-quality Greek marble
- Elegant finish with optimal water flow performance
- Developed through Oxygon's in-house expertise and industry know-how

Pricing will be issued during 2026.

Until official pricing is released, if you have a request for any of the above items, we invite you to contact us directly. Our team will be happy to assist with technical details, availability, and project-specific solutions.

Oxygon continues to shape the future of pool design—where natural materials meet engineering excellence.



Profile Type HO

DIMENSIONS:
Length: 610mm
Width: 200/250/300mm
Thickness: 50mm

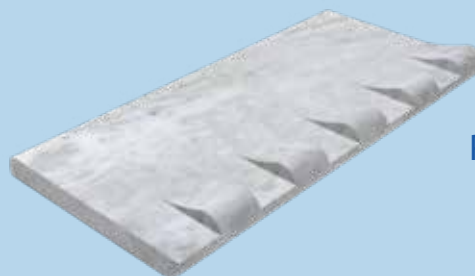

Profile Type C1H

DIMENSIONS:
Length: 610mm
Width: 200/250/300mm
Thickness: 50mm

Grating Type 0B3

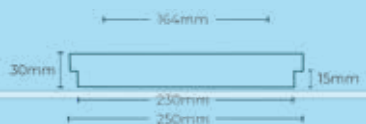

| CODE | MARBLE | LENGTH mm | WIDTH mm | THICKNESS mm | PRICE / lin. meter |
|------------|-------------|-----------|----------|--------------|--------------------|
| 430.40.152 | Kavala | 610 | 300 | 30 | 261,36 € |
| 430.40.153 | | 610 | 200-250 | 30 | 240,24 € |
| 430.40.154 | East Grey | 610 | 300 | 30 | 319,44 € |
| 430.40.155 | | 610 | 200-250 | 30 | 293,04 € |
| 430.40.156 | Sunny | 610 | 300 | 30 | 221,76 € |
| 430.40.157 | | 610 | 200-250 | 30 | 203,28 € |
| 430.40.158 | California | 610 | 300 | 30 | 348,48 € |
| 430.40.159 | | 610 | 200-250 | 30 | 319,44 € |
| 430.40.160 | Aliveri | 610 | 300 | 30 | 255,02 € |
| 430.40.161 | | 610 | 200-250 | 30 | 233,77 € |
| 430.40.162 | Vratsa | 610 | 300 | 30 | 348,48 € |
| 430.40.163 | | 610 | 200-250 | 30 | 319,44 € |
| 430.40.164 | Sinai Pearl | 610 | 300 | 30 | 261,36 € |
| 430.40.165 | | 610 | 200-250 | 30 | 240,24 € |

Grating Type 8EU



| CODE | MARBLE | LENGTH mm | WIDTH mm | THICKNESS mm | PRICE / lin. meter |
|------------|-------------|-----------|----------|--------------|--------------------|
| 430.40.180 | Kavala | 610 | 300 | 30 | 414,48 € |
| 430.40.181 | | 610 | 200-250 | 30 | 372,24 € |
| 430.40.182 | East Grey | 610 | 300 | 30 | 475,20 € |
| 430.40.183 | | 610 | 200-250 | 30 | 427,68 € |
| 430.40.184 | Sunny | 610 | 300 | 30 | 374,88 € |
| 430.40.185 | | 610 | 200-250 | 30 | 332,64 € |
| 430.40.186 | California | 610 | 300 | 30 | 504,24 € |
| 430.40.187 | | 610 | 200-250 | 30 | 454,08 € |
| 430.40.188 | Aliveri | 610 | 300 | 30 | 431,11 € |
| 430.40.189 | | 610 | 200-250 | 30 | 382,54 € |
| 430.40.190 | Vratsa | 610 | 300 | 30 | 504,24 € |
| 430.40.191 | | 610 | 200-250 | 30 | 454,08 € |
| 430.40.192 | Sinai Pearl | 610 | 300 | 30 | 414,48 € |
| 430.40.193 | | 610 | 200-250 | 30 | 372,24 € |

Grating Type 0C



| CODE | MARBLE | LENGTH mm | WIDTH mm | THICKNESS mm | PRICE / lin. meter |
|------------|-------------|-----------|----------|--------------|--------------------|
| 430.40.124 | Kavala | 610 | 300 | 30 | 256,08 € |
| 430.40.125 | | 610 | 200-250 | 30 | 232,32 € |
| 430.40.126 | East Grey | 610 | 300 | 30 | 319,44 € |
| 430.40.127 | | 610 | 200-250 | 30 | 290,40 € |
| 430.40.128 | Sunny | 610 | 300 | 30 | 211,20 € |
| 430.40.129 | | 610 | 200-250 | 30 | 192,72 € |
| 430.40.130 | California | 610 | 300 | 30 | 351,12 € |
| 430.40.131 | | 610 | 200-250 | 30 | 319,44 € |
| 430.40.132 | Aliveri | 610 | 300 | 30 | 242,88 € |
| 430.40.133 | | 610 | 200-250 | 30 | 221,63 € |
| 430.40.134 | Vratsa | 610 | 300 | 30 | 351,12 € |
| 430.40.135 | | 610 | 200-250 | 30 | 319,44 € |
| 430.40.136 | Sinai Pearl | 610 | 300 | 30 | 256,08 € |
| 430.40.137 | | 610 | 200-250 | 30 | 232,32 € |

Grating Type 9M

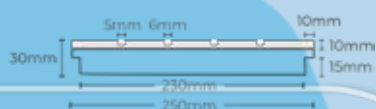

| CODE | MARBLE | LENGTH mm | WIDTH mm | THICKNESS mm | PRICE / lin. meter |
|------------|-------------|-----------|----------|--------------|--------------------|
| 430.40.194 | Kavala | 610 | 300 | 30 | 427,68 € |
| 430.40.195 | | 610 | 200-250 | 30 | 380,16 € |
| 430.40.196 | East Grey | 610 | 300 | 30 | 496,32 € |
| 430.40.197 | | 610 | 200-250 | 30 | 443,52 € |
| 430.40.198 | Sunny | 610 | 300 | 30 | 377,52 € |
| 430.40.199 | | 610 | 200-250 | 30 | 335,28 € |
| 430.40.200 | California | 610 | 300 | 30 | 530,64 € |
| 430.40.201 | | 610 | 200-250 | 30 | 475,20 € |
| 430.40.202 | Aliveri | 610 | 300 | 30 | 434,15 € |
| 430.40.203 | | 610 | 200-250 | 30 | 385,57 € |
| 430.40.204 | Vratsa | 610 | 300 | 30 | 530,64 € |
| 430.40.205 | | 610 | 200-250 | 30 | 475,20 € |
| 430.40.206 | Sinai Pearl | 610 | 300 | 30 | 427,68 € |
| 430.40.207 | | 610 | 200-250 | 30 | 380,16 € |

Grating Type 1D

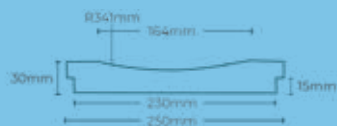
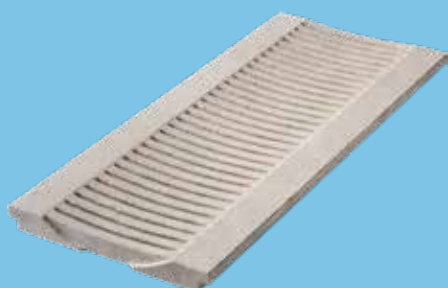

| CODE | MARBLE | LENGTH mm | WIDTH mm | THICKNESS mm | PRICE / lin. meter |
|------------|-------------|-----------|----------|--------------|--------------------|
| 430.40.138 | Kavala | 610 | 300 | 30 | 282,48 € |
| 430.40.139 | | 610 | 200-250 | 30 | 256,08 € |
| 430.40.140 | East Grey | 610 | 300 | 30 | 351,12 € |
| 430.40.141 | | 610 | 200-250 | 30 | 319,44 € |
| 430.40.142 | Sunny | 610 | 300 | 30 | 232,32 € |
| 430.40.143 | | 610 | 200-250 | 30 | 211,20 € |
| 430.40.144 | California | 610 | 300 | 30 | 385,44 € |
| 430.40.145 | | 610 | 200-250 | 30 | 351,12 € |
| 430.40.146 | Aliveri | 610 | 300 | 30 | 267,17 € |
| 430.40.147 | | 610 | 200-250 | 30 | 242,88 € |
| 430.40.148 | Vratsa | 610 | 300 | 30 | 385,44 € |
| 430.40.149 | | 610 | 200-250 | 30 | 351,12 € |
| 430.40.150 | Sinai Pearl | 610 | 300 | 30 | 282,48 € |
| 430.40.151 | | 610 | 200-250 | 30 | 256,08 € |

Grating Type 0U

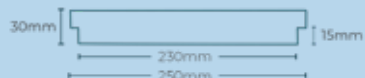

| CODE | MARBLE | LENGTH mm | WIDTH mm | THICKNESS mm | PRICE / lin. meter |
|------------|-------------|-----------|----------|--------------|--------------------|
| 430.40.208 | Kavala | 610 | 300 | 30 | 221,76 € |
| 430.40.209 | | 610 | 200-250 | 30 | 200,64 € |
| 430.40.210 | East Grey | 610 | 300 | 30 | 277,20 € |
| 430.40.211 | | 610 | 200-250 | 30 | 250,80 € |
| 430.40.212 | Sunny | 610 | 300 | 30 | 182,16 € |
| 430.40.213 | | 610 | 200-250 | 30 | 166,32 € |
| 430.40.214 | California | 610 | 300 | 30 | 306,24 € |
| 430.40.215 | | 610 | 200-250 | 30 | 277,20 € |
| 430.40.216 | Aliveri | 610 | 300 | 30 | 209,48 € |
| 430.40.217 | | 610 | 200-250 | 30 | 191,27 € |
| 430.40.218 | Vratsa | 610 | 300 | 30 | 306,24 € |
| 430.40.219 | | 610 | 200-250 | 30 | 277,20 € |
| 430.40.220 | Sinai Pearl | 610 | 300 | 30 | 221,76 € |
| 430.40.221 | | 610 | 200-250 | 30 | 200,64 € |

Trimmer T3

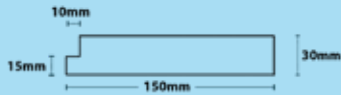

| CODE | MARBLE | LENGTH mm | WIDTH mm | THICKNESS mm | PRICE / lin. meter |
|------------|-------------|-----------|----------|--------------|--------------------|
| 430.40.222 | Kavala | 610 | 260-310 | 30 | 113,52 € |
| 430.40.223 | | | 210-250 | 30 | 84,48 € |
| 430.40.224 | | | 200 | 30 | 58,08 € |
| 430.40.225 | East Grey | 610 | 260-310 | 30 | 147,84 € |
| 430.40.226 | | | 210-250 | 30 | 110,88 € |
| 430.40.227 | | | 200 | 30 | 73,92 € |
| 430.40.228 | Sunny | 610 | 260-310 | 30 | 92,40 € |
| 430.40.229 | | | 210-250 | 30 | 68,64 € |
| 430.40.230 | California | 610 | 200 | 30 | 47,52 € |
| 430.40.231 | | | 260-310 | 30 | 161,04 € |
| 430.40.232 | | | 210-250 | 30 | 121,44 € |
| 430.40.233 | Aliveri | 610 | 200 | 30 | 81,84 € |
| 430.40.234 | | | 260-310 | 30 | 106,26 € |
| 430.40.235 | | | 210-250 | 30 | 78,94 € |
| 430.40.236 | Vratsa | 610 | 200 | 30 | 54,65 € |
| 430.40.237 | | | 260-310 | 30 | 161,04 € |
| 430.40.238 | | | 210-250 | 30 | 121,44 € |
| 430.40.239 | Sinai Pearl | 610 | 200 | 30 | 81,84 € |
| 430.40.240 | | | 260-310 | 30 | 116,16 € |
| 430.40.241 | | | 210-250 | 30 | 87,12 € |
| 430.40.242 | | 610 | 200 | 30 | 58,08 € |

Overflow system N4



The classic overflow system
With 30mm thickness
stone, for flat coping,
support lane (trimmer)
and drain grate



Overflow system N8



The almost
invisible open
slot of collecting
water



Overflow system N9



Collecting the water
across the coping,
without slotted drain
grates

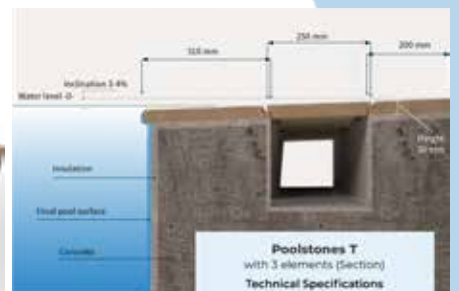

Overflow system N12



By reinforcing the drain grate underneath we keep hidden all vertical slots, and we show just one slot along the water

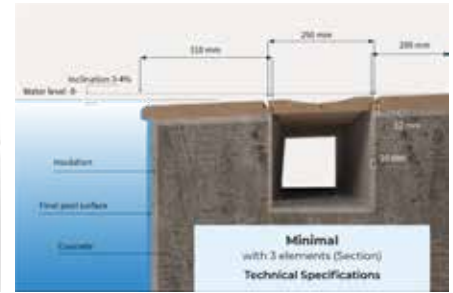
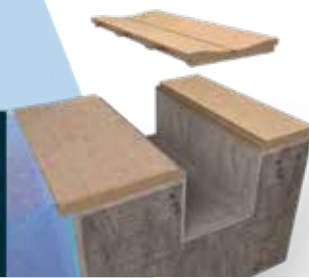

Overflow system N13



The most luxury slotted overflow system, which ensures wave breakwater

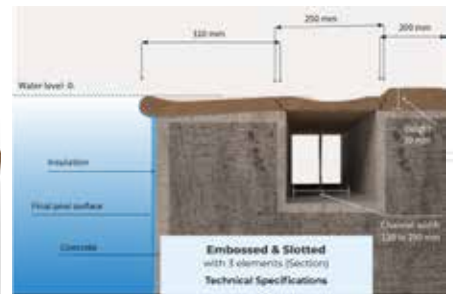

Overflow system N18



The narrowest overflow system with a single face channel cover

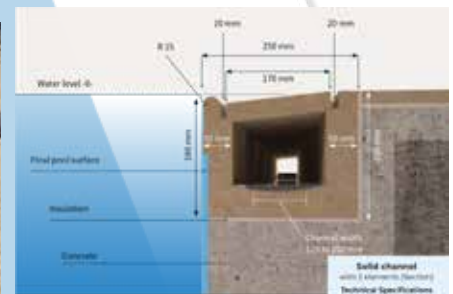

Overflow system N20



Modern overflow system with slots parallel to the coping

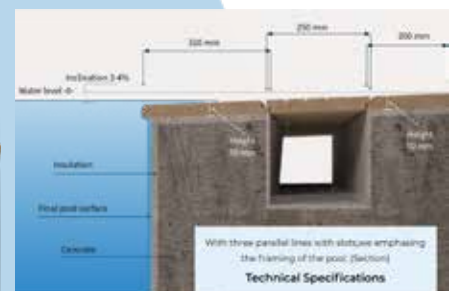

Overflow system N21



A unique hidden overflow system of two elements

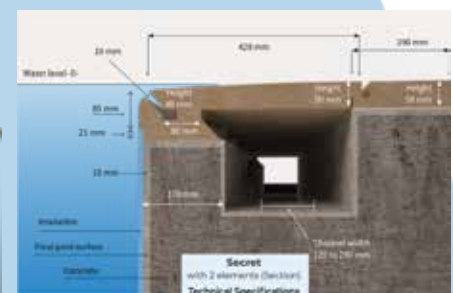

KAVALA



Color: White

Testing

Compressive Strength: 79.3 MPa
 Water Absorption: 0.07 % wt
 Density: 2709 Kg/m³
 Flexural Strength: 15.3 MPa



DRY SANDBLASTED



WET SANDBLASTED

EAST GREY



Color: Grey

Testing

Compressive Strength: 90 - 112 MPa
 Water Absorption: 0.75 % wt
 Density: 2723 Kg/m³
 Flexural Strength: 18.30 - 21.99 MPa



DRY SANDBLASTED



WET SANDBLASTED

SUNNY



Color: Yellow

Testing

Compressive Strength: 85 - 87 MPa
 Water Absorption: 0.35 - 0.35 % wt
 Density: 2618 - 2628 Kg/m³
 Flexural Strength: 10.5 - 10.7 MPa



DRY SANDBLASTED



WET SANDBLASTED

CALIFORNIA



Color: Yellow

Testing

Compressive Strength: 85 - 87 MPa
 Water Absorption: 0.2% wt
 Density: 2520 Kg/m³
 Flexural Strength: 14.2 MPa



DRY SANDBLASTED



WET SANDBLASTED

ALIVERI



Color: Grey

Testing

Compressive Strength: 79 N/mm²
 Water Absorption: 0.3 wt
 Density: 2722 Kg/m³
 Flexural Strength: 23.6 N/mm²



DRY SANDBLASTED



WET SANDBLASTED

VRATSA



Color: Beige

Testing

Compressive Strength: 120 - 140 MPa
 Water Absorption: 4.5 - 5 % wt
 Density: 2200 - 2300 Kg/m³
 Flexural Strength: 14 - 20 MPa



DRY SANDBLASTED



WET SANDBLASTED

SINAI PERL



Color: Sand color

Testing

Compressive Strength:
 Water Absorption: 1.40
 Density: 2638 Kg/m³
 Flexural Strength: 6.82 MPa



DRY SANDBLASTED



WET SANDBLASTED

IM3366

33x66 cm

Ionian Mix

Attracting attention with its colors and texture, Ionian Mix almost becomes a part of the natural environment with its design fully compatible with nature. This product, dominated by green and earthy tones, creates a relaxing and balancing comfort in the pool. Products that integrate with nature with their natural color transitions invite you to the pool with their unique patterns and visual appeal. You can immerse yourself in a natural, clean and safe pool thanks to Ionian Mix products, where you will feel that you are much more intertwined with nature

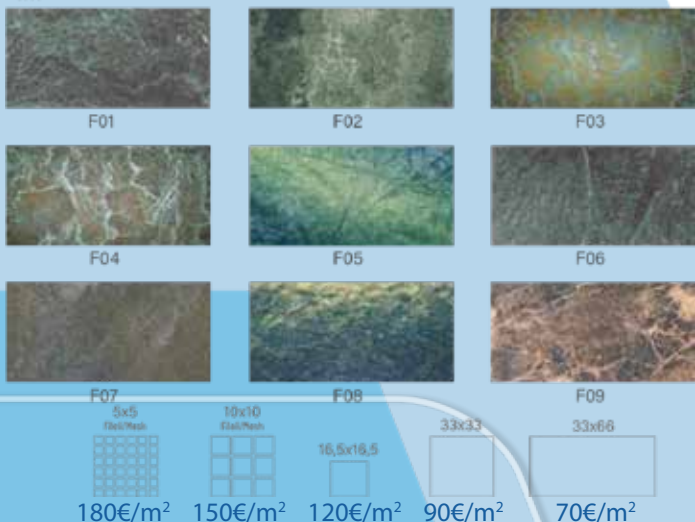

EV3366

33x66 cm

Epirus Verde

Epirus Verde, which combines light and dark green colors with black shaded tones, gives pools a fascinating look. Epirus Verde, which gives people positive energy and peace with its green colors, reflects all these positive emotions to the pool in the best way. The green color, which symbolizes revival, makes you feel more fit and healthy with its regenerative energy. Using Epirus Verde products, which make you feel peaceful and vigorous with their colors, in your pool will help you get rid of the tiredness of the day and relax.

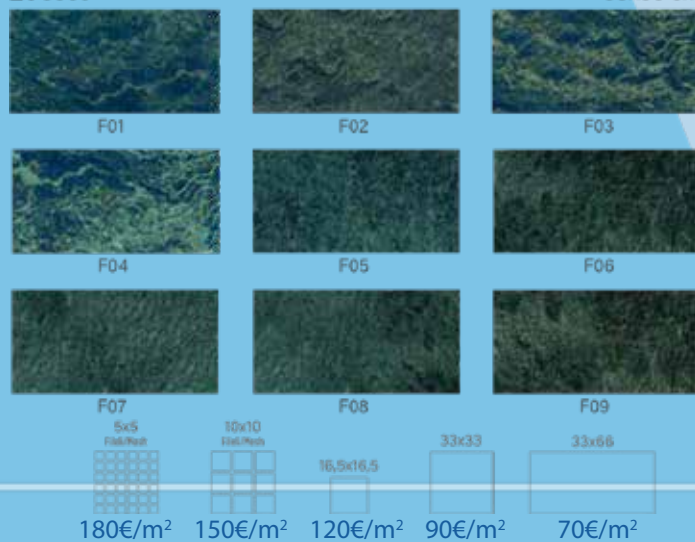

33x66 cm

Corfu Mix

Corfu Mix leaves the usual design practices behind with the ocean breeze it brings to the pools. Corfu Mix models help you purify you from all negativities by relaxing your body, soul and mind like an ocean therapy. Arousing a feeling of happiness and peace in the person entering the pool, Corfu Mix opens your heart with its light tones with Corfu Mix white and blue transitions. Reflecting the purifying effect of water on pools, the products create spaces that will relax your soul with their natural tones. With Corfu Mix, which brings a different breath to the pools with its unique design and texture, you will feel the freshness of the ocean in your pool.

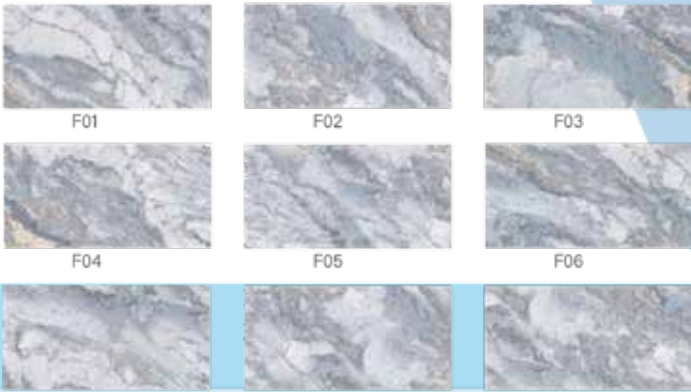

| | | | | |
|-------------------------|---------------------|---------------------|--------------------|--------------------|
| F07 5x5 Fish/Peck | 10x10 Fish/Peck | F08 16,5x16,5 | 33x33 | F09 33x66 |
| 180€/m ² | 150€/m ² | 120€/m ² | 90€/m ² | 70€/m ² |



33x66 cm

Athens Antique Grey

Adding a magnificent ambiance to pools with its elegant lines, Athens Antique Grey is the choice of those who want to capture a natural atmosphere in their pools. The products, which give the pools a soft appearance with their relaxing and calming effect, reinforce the naturalness with the natural stone texture on the surface and nine different tone transitions. Athens Antique Grey, which symbolizes simplicity and nobility with the energy of grey that provides a soothing and relaxing effect, displays a plain appearance in pools. Products that blend the colors of nature in an aesthetic way, combine natural forms with a modern style.

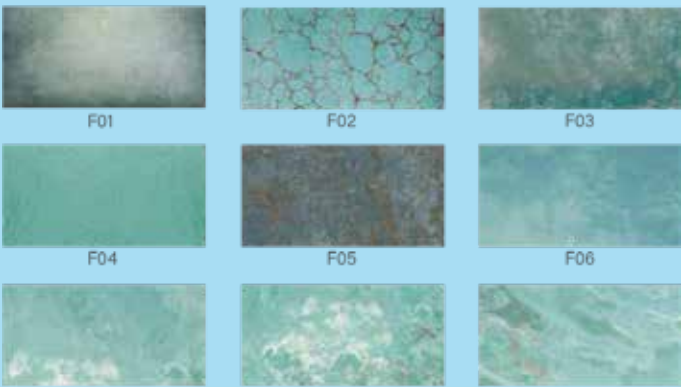

| | | | | |
|-------------------------|---------------------|---------------------|--------------------|--------------------|
| F07 5x5 Fish/Peck | 10x10 Fish/Peck | F08 16,5x16,5 | 33x33 | F09 33x66 |
| 180€/m ² | 150€/m ² | 120€/m ² | 90€/m ² | 70€/m ² |



33x66 cm

Creta Mix

Creta Mix, which is accepted as the color of balance because it contains the blue of the sky and the green of the earth, adds an aesthetic appearance to the pools and positively affects your mental and physical health. Creta Mix, which has varying colors from sky blue to greenish blue, has alternative options in different textures. Carrying the colors of sincerity and happiness, Creta Mix also reflects the relaxing power of water to the pools. With Creta Mix, which spreads the peace and calmness of blue and the vitality of green, stress and fatigue disappear.

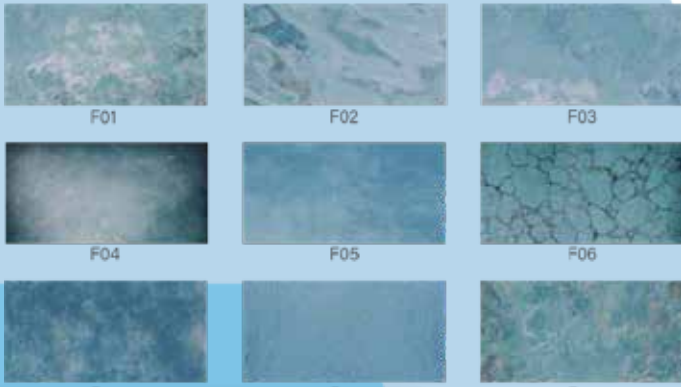

180€/m² 150€/m² 120€/m² 90€/m² 70€/m²



33x66 cm

Rodos

Porcelain tiles that we produce in the Rodos concept with their special texture and blue colors bring the feeling of coolness of the sea to the pools. Rodos models, which give peace with their blue and clear colors, add elegance to pools with their modern design and light blue combinations. Rodos porcelain tiles, which have different color transitions from sea color to light sky blue, bring a unique ambiance to pools with their unique texture. Enjoying the pool becomes insatiable with these blue colored tiles, which reinforce the feelings of serenity and calmness. Blue energy also provides physical and spiritual relaxation in people by having a meditative effect in the pools.

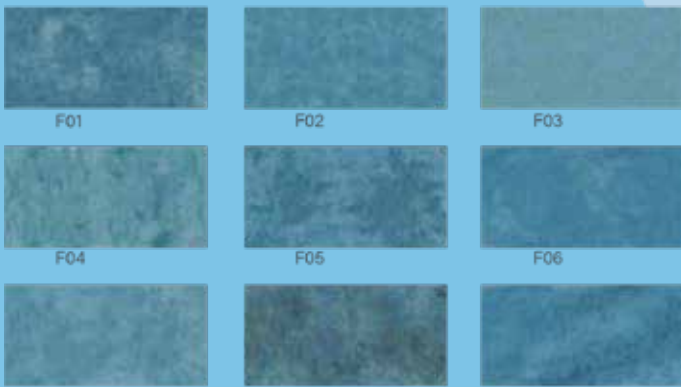

180€/m² 150€/m² 120€/m² 90€/m² 70€/m²



33x66 cm

Santorini White

Santorini White, which takes its inspiration from the perfect patterns of nature and its texture from the elegance of marble, creates refined and sparkling spaces with its eye-catching design. A candidate to be indispensable for stylish pools, Santorini White adds dynamism to pools with contemporary touches. These white products, which symbolize cleanliness and healing, are indispensable for all times with their natural appearance. Products that carry all the emotions that white makes us feel, such as brightness, freshness, and refreshing effect to the pools, also contribute to inner purification with the power of white color.

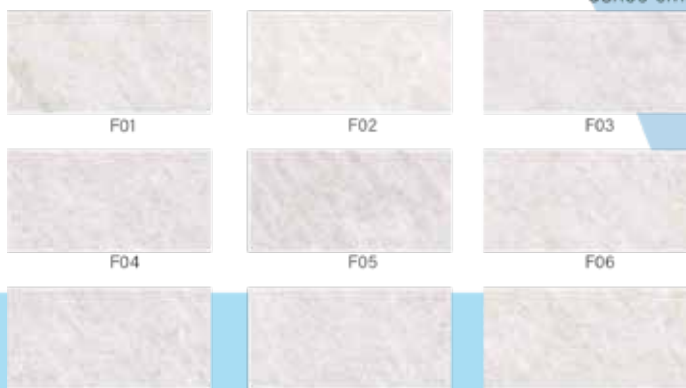

| | | | | |
|---------------------------|----------------------|---------------------|--------------------|--------------------|
| F07 5x5 Flat/Recess | 10x10 Flat/Recess | F08 16,5x16,5 | 33x33 | F09 33x66 |
| 180€/m ² | 150€/m ² | 120€/m ² | 90€/m ² | 70€/m ² |



33x66 cm

Mani Beige

Mani Beige, which appears as the color of nobility and elegance with its harmony with other colors and the feeling of spaciousness it adds to the environment in which it is used, brings calmness and peace to the pools. Being one of the lightest shades of natural colors, beige is composed of a mixture of earthy brown and pure white, reflecting the calm and calming effect of nature on the pools. Resembling natural stone with its eye-catching and original lines, the pools offer a modern and heartwarming atmosphere with Mani Beige in-pool tiles. You can reveal your own style with Mani Beige, which is the choice of those who want to catch the simplicity and naturalness in their pool.



| | | | | |
|---------------------------|----------------------|---------------------|--------------------|--------------------|
| F07 5x5 Flat/Recess | 10x10 Flat/Recess | F08 16,5x16,5 | 33x33 | F09 33x66 |
| 180€/m ² | 150€/m ² | 120€/m ² | 90€/m ² | 70€/m ² |

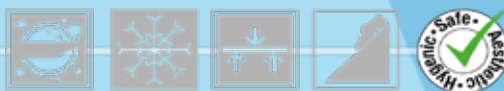

Thebes

Thebes, named after a city in the central Greece, brings the breezes of nature to the pools with its attractive and rich appearance. Featuring different shades of green on its surface, Thebes offers a noble elegance with its white, beige, black and brown textures. Products that reflect a natural, aesthetic and refined taste give pools a high-energy and sophisticated look. Bringing a different style to pools with its natural form, pioneering style and aesthetic stance, Sukabumi puts its signature on unique pools.

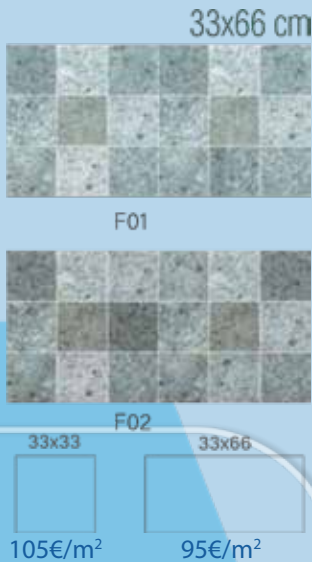

Skopelos Green

Making you feel the effect of green tones, which stand out with their calming and healing properties, in the pools, Skopelos Green exhibits a real integrity with nature. The products, which successfully present the natural combination of green and earth tones, which symbolize freshness and rebirth, bring the freshness of nature to the pools. The color of earth, which is the color of returning to nature and serenity, spreads a peaceful and fertile energy just like the soil itself, making those who enter the pool feel better and healthier. Its green color, which has its roots in nature, comes together with the turquoise tones of the ocean waters and the striking yellows of the sun, creating a contrasting beauty in the space.

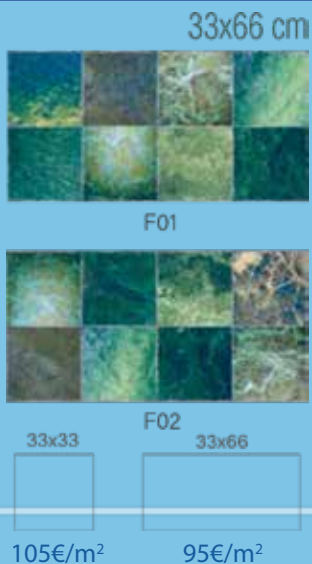

33x66 cm



F01



F02

33x33



105€/m²

33x66



95€/m²

Delphi Anthracite

Bringing together natural forms and minimalist lines, Delphi Anthracite integrates pools with nature with a simple elegance. The products that radiate freshness to pools with their lively designs, follow the traces of nature with their colors inspired by nature, curved lines on the surface and all their naturalness. Products that rehabilitate those who enter the pool not only mentally but also physically with their colors and textures, give pools a privileged identity with their calming, concentration-increasing and stress relieving effects.



DELPHI ANTHRACITE



33x66 cm



F01



F02

33x33



105€/m²

33x66

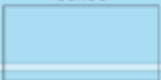

95€/m²

Amorgos Cobalt

Amorgos Cobalt, in dark and deep blue tones, creates a lively, fun and colorful atmosphere with the balance it provides in the pools. Creating a stylish concept with its flamboyant design, Amorgos Cobalt brings an energetic atmosphere to the pools with its dominant colors. These products, which contain the most vital colors of blue, bring peace and comfort to the pools by evoking freedom as they symbolize the color of the sky and the vast oceans.



AMORGOS COBALT



33x66 cm



F01



F02

33x33



105€/m²

33x66

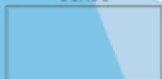

95€/m²

Pelion Turquoise

Turquoise, which adds joy and vitality thanks to its effect that keeps attention and concentration alive, is adapted to the power of nature in Pelion Turquoise, providing a magnificent harmony with the earth tone. Being in synergy with nature with a refreshing touch, Pelion Turquoise makes you forget the chaos of city life by transforming pools into retreats with earth tones that create a timeless effect. Reflecting the positive power of nature with the feeling of spaciousness it adds to the pools, the products add comfort and elegance to the pools with their natural texture.



PELION TURQUOISE



33x33 cm



F01



F02



F03



F04



F05



F06



F07



F08



F09



F10



F11



F12



F13



F14



F15



F16



F17



F18



F19



F20

105€/m²

Evros Tropic

Inspired by exotic plant patterns, Evros Tropic invites you to an unusual pool. The designs that give life to a different texture in every frame offer an original and creative flooring opportunity. Bringing a new breath to pools with its carefully chosen colors, Evros Tropic creates a unique pool environment with its iconic and striking motifs. Evros Tropic products, which create characteristic pools with their attractive design, bring a new understanding to pools with their aesthetic and innovative concept. The products that transform pools into a tropical purification point with their dazzling natural beauty make you feel special while increasing your swimming pleasure with their healing and aesthetic stance.



EVROS TROPIC



Pool Mix

Reflecting the contrast harmony of colors in its most natural form, Pool Mix offers an original creativity in design thanks to its extraordinary lines. The products, which carry all the colors of nature from the blue of the sky to the brown tone of the earth, stand out with their design beyond all the pool tiles you know. The choice of those who desire a real change in pools with soothing coffees and blues inspired by nature, orange and yellow transitions that make you feel the warmth of the sun, Pool Mix combines saturated and striking colors with modern designs and elegant lines. Pool Mix, which is preferred in thermal pools as well as private pools, brings together warm and cold colors and offers a variety of flooring. Offering unique options to those who want to make a difference in their pools, the products provide more comfort and convenience to their users.

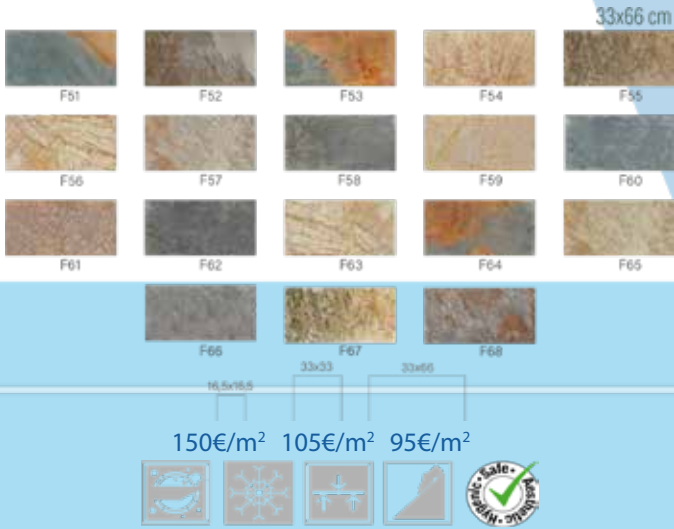

Fossil Mix

Inspired by the petrified, lively and lively pieces found in the rocks at the bottom of the shallow seas, Fossil Mix represents a nobility beyond time with the motifs used on its surface. Adding movement to the pools with its lines reflecting the life in the sea, Fossil Mix changes the atmosphere of the pool with its carefully selected natural colors. Inspiring a rich design with different flooring combinations, the products offer an extraordinary concept that will lead new trends in pools with their contrasting colors. The collection, which has rich pattern options, brings an artistic, brand new and decorative approach to pools with the use of mixing patterns. Bringing life to pools, Fossil Mix is as real as nature, as fascinating as nature with its unique texture.

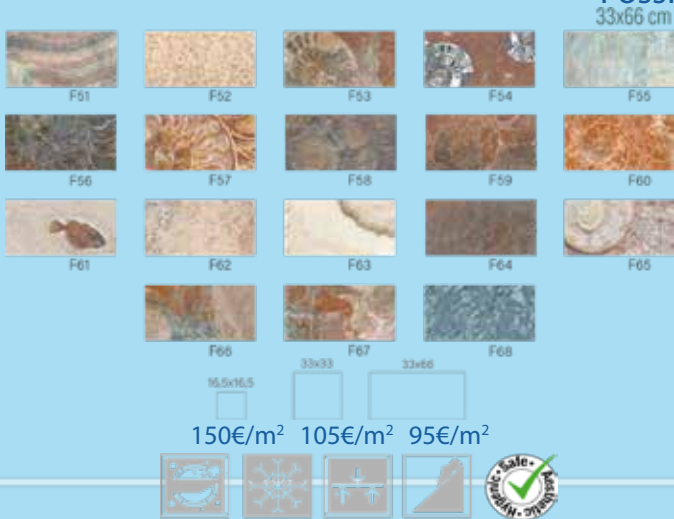

Sparti Verde

33x66 cm

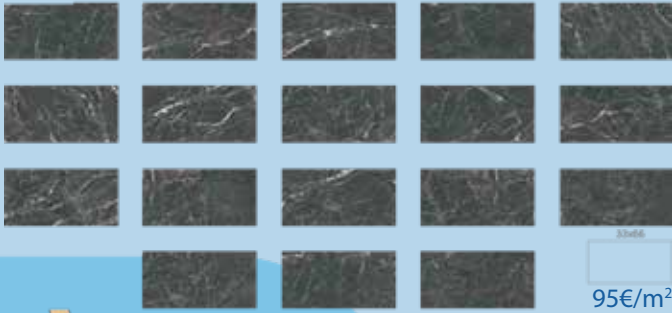

*There may be a tonal difference between the handle, grids and terrace antislip tiles due to the natural appearance.

Sparti Verde, which carries its natural color and texture to outdoor terrace tiles, reflects a different style and conveys the spacious atmosphere of dark green color to spaces in today's increasingly longing for nature. Centering on naturalness, the products are starting a new trend outdoors with their deep and dark green color and minimalist and natural white lines. Sparti Verde, which will be the favorite of those who want to feel the original and mysterious atmosphere of nature on their terraces, transforms outdoor spaces into a stylish identity with the durability and charm of porcelain.



Larissa Grey

33x66 cm

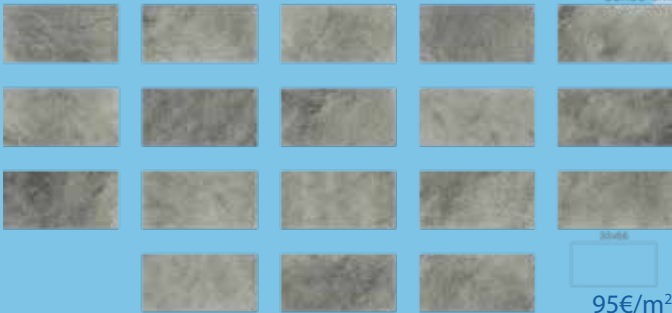

*There may be a tonal difference between the handle, grids and terrace antislip tiles due to the natural appearance.

Bringing a simple elegance to terraces with its light/dark grey colours, Larissa Grey can be easily used outdoors with its porcelain quality and durability. The products, which adapt to the space they are used in with their natural appearance, create decent and prestigious spaces with their gray colors. Combining the natural texture of natural stone with porcelain, Larissa Grey brings the simplicity and cleanliness of light tones to your terraces.



Delphi Anthracite

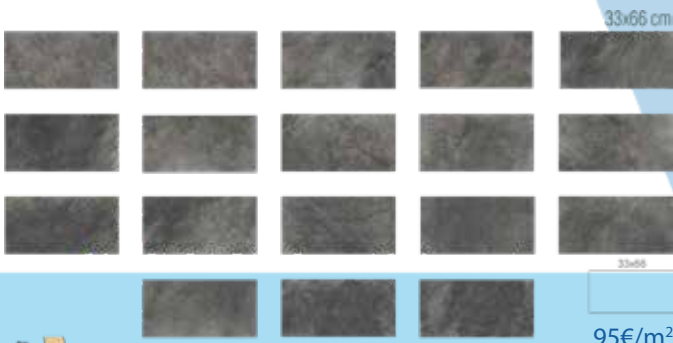

Reflecting the heavy and impressive stance of the anthracite color to the terraces, Delphi Anthracite is the favorite of those who want to capture a noble style in spaces. Bringing an elegant look to the terraces with its modern and aesthetic details, Delphi Anthracite is ideal for those who want to create self-confident and remarkable spaces. You can add energy and harmony to the brave, strong and determined stance of Delphi Anthracite with the light color tiles you choose inside the pool.

*There may be a tonal difference between the handle, grids and terrace antislip tiles due to the natural appearance.



Olympos Beige

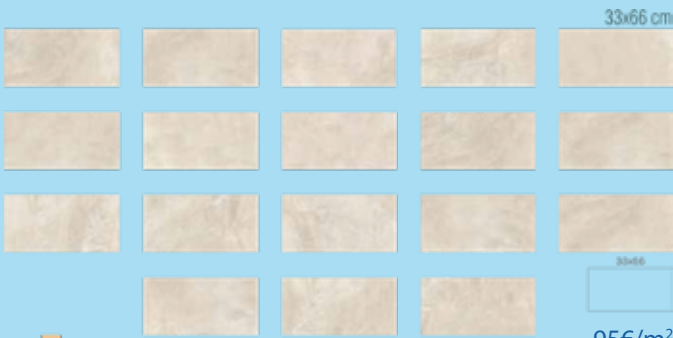

Olympos Beige offers plain terraces with beige colors that appear as the color of sand grains and natural stones in nature and turns it into a bright environment. Olympos Beige, which makes the terraces sparkle with its beige color, which is the symbol of elegance that creates intimate and spacious spaces with its heartwarming tones. A harmonious combination with all colors, terraces get a perfect look with Olympos Beige products.

*There may be a tonal difference between the handle, grids and terrace antislip tiles due to the natural appearance.



Volos Grey

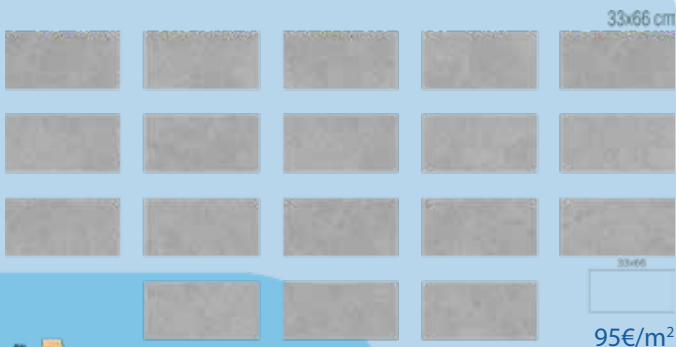

33x66 cm

33x66

95€/m²

*There may be a tonal difference between the handle, grids and terrace antislip tiles due to the natural appearance.

Volos Grey offers plain terraces with grey colors that appear as the color of natural stones in nature and turns it into a bright environment. Volos Grey, which makes the terraces sparkle with its grey color, which is the symbol of elegance that creates intimate and spacious spaces with its heartwarming tones. A harmonious combination with all colors, terraces get a perfect look with Olympos Beige products.



VOLOS GREY

Drama Mocha

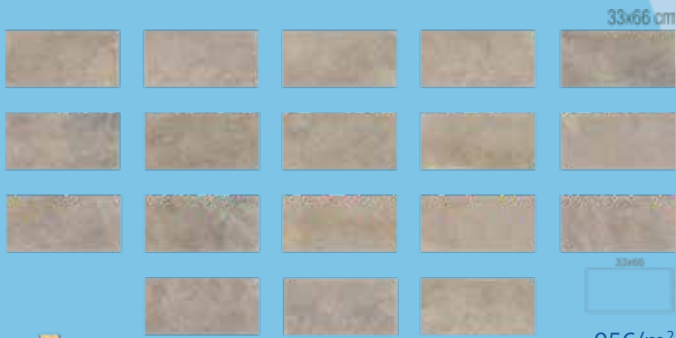

33x66 cm

33x66

95€/m²

*There may be a tonal difference between the handle, grids and terrace antislip tiles due to the natural appearance.

Drama Mocha, which offers calm pattern options by using earthy colors that warm the soul, adds a luxurious and warm touch to outdoor spaces. Moving away from the ordinary with its soft colors and simple delicacy, Drama Mocha enriches the areas where it is used and turns the terraces into peaceful spaces. The purifying effect of warm earth tones slows the rapid flow of time, allowing you to turn to nature and naturalness, and brings a calm lifestyle to your feet by removing your worries. You can create wonderful combinations with these earth-colored products, which reflect the naturalness of the environment, and with pool tiles in blue and green tones.



DRAMA MOCHA

Athos Cotto

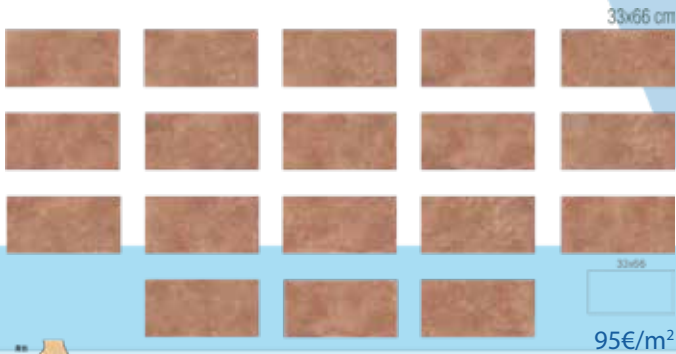

Developed with inspiration from nature's gift, soil, Athos Cotto adds a remarkable touch to pools. Athos Cotto, which impressively reveals traditional pieces by transforming them into a contemporary and natural texture, adds a warm atmosphere to living spaces with its colors and brings energy and happiness to the person by reminding the earth in the spaces where it is used. The products, which display a natural look with their brick color, highlight the cheerful and positive emotions and reflect the energy they contain to the pools. Bringing the warmth and richness of nature to the pools, Athos Cotto creates an eye-catching atmosphere in the areas where it is used.



*There may be a tonal difference between the handle, grids and terrace anti-slip tiles due to the natural appearance.



Kos Beige Stone



Reflecting a magnificent style with its creative patterns and marble texture, Kos Beige Stone appeals to those who cannot give up natural lines. Adding a different dimension to terraces with its charming and aesthetic line, Kos Beige Stone raises the energy of terraces with its color transitions and plain design. The unique beauty of beige, which is the most elegant color of nature by combining the color of earth and pure white, is also reflected in the products. Kos Beige Stone outdoor terrace tiles are the primary choice of those who embrace simplicity and elegance as a style while embracing nature.



*There may be a tonal difference between the handle, grids and terrace anti-slip tiles due to the natural appearance.



Step Anti-Slip

33x66 cm



Antislip stair step tiles left ending part



Antislip stair step tiles right ending part



Antislip stair step tiles

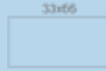

79€/pc

* Stair antislips are produced of all tiles in this catalog.

Stair Antislip tiles with a long life span and high safety prevent the risk of slipping and falling in and out of the pool with their finely thought details. Thus, stair antislips, which integrate the relaxing effect of swimming pools with a safe use, allow you to enter the pool with peace of mind. These antislips, which have high resistance to abrasion, scratching and impact with their superior strength and durability performance, also draw attention with their natural and aesthetic appearance.

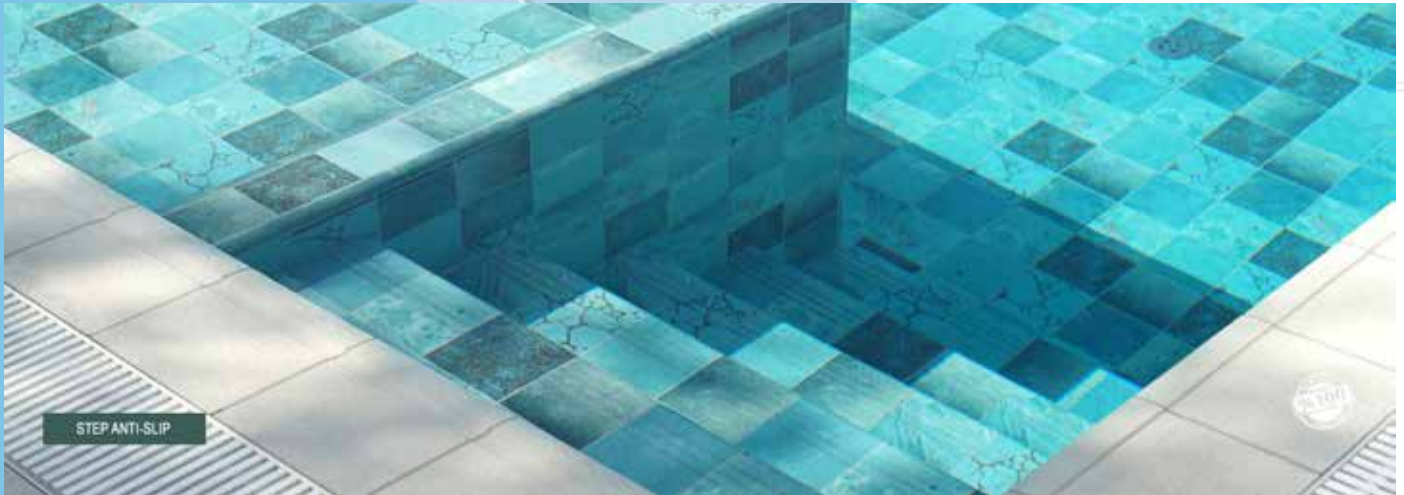

Infinity Pool

60x60 cm



30x60 cm



60x60



75€/pc



95€/pc

* Product surfaces are plain/without relief.
* Infinity antislips are produced of all tiles in this catalog.
* Different sizes from 60x60 cm can be cut.

Specially designed for those who want to swim against the magnificent nature or sea view, Infnitive Antislip Tiles provide a unique view by combining the pool and the sea at a common point. Thus, the pools, which appear as a whole with the horizon line and draw an endless water image, gain a fascinating atmosphere thanks to Infinity Antislip Tiles. A magnificent pool pleasure awaits you with Infinity Antislip Tiles, which enable the design of infinity pools, which have become quite trendy in recent years. These antislips, which are resistant to high temperatures and freezing like all products, can be used safely for many years as they are produced from 100% porcelain material.



Handles

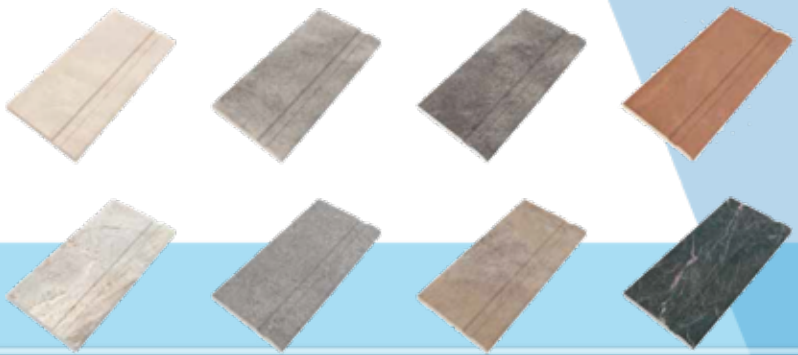

25x50 / 30x50 cm



150€/pc 120€/pc

Handle Corners

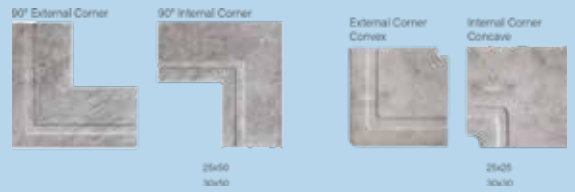

290€/pc



Flat Handles

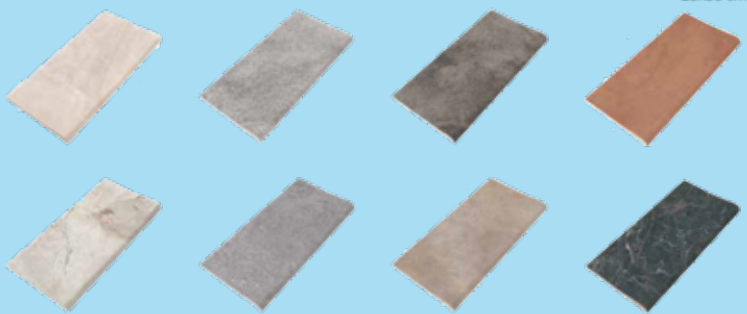

25x50 cm



150€/pc 120€/pc

Flat Handle Corners



290€/pc

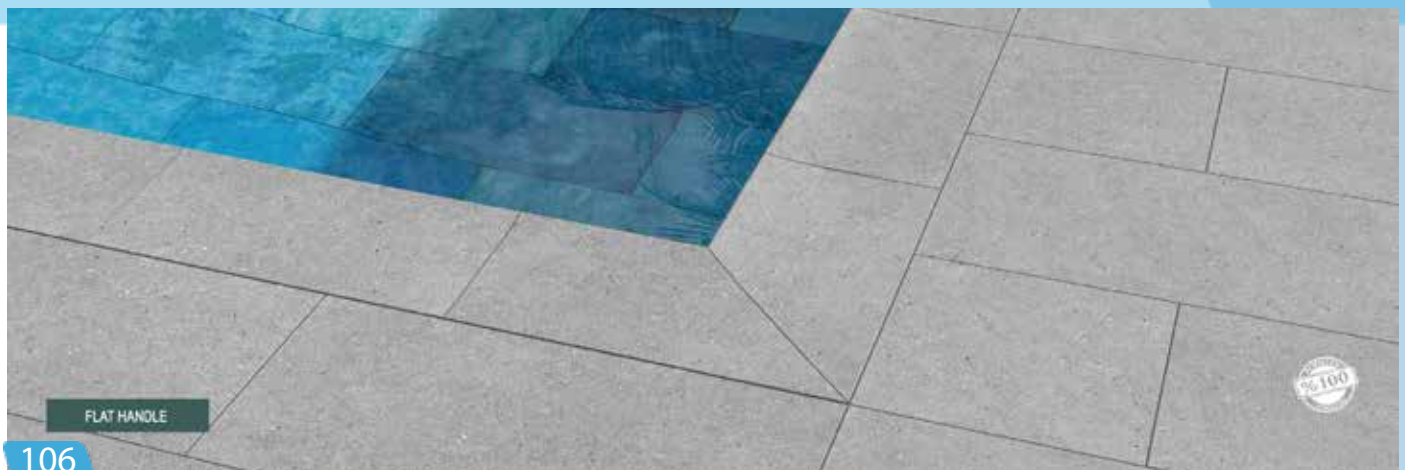

Hidden Grid

25x50 / 25x65 / 30x65 cm

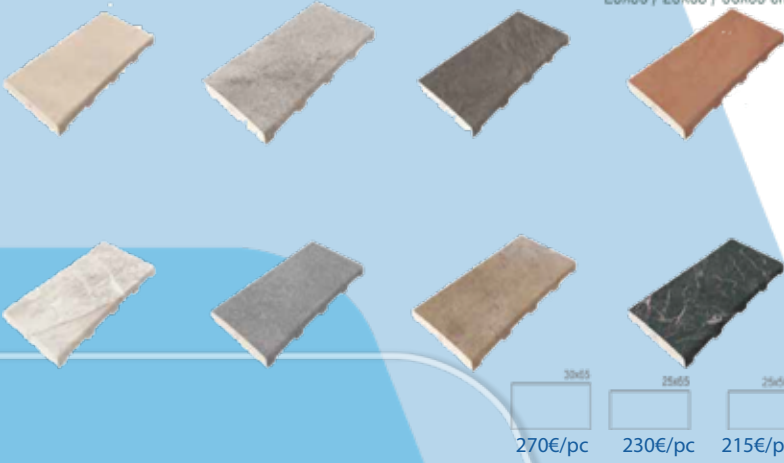

Special Parts



Concave Convex

4x33 cm

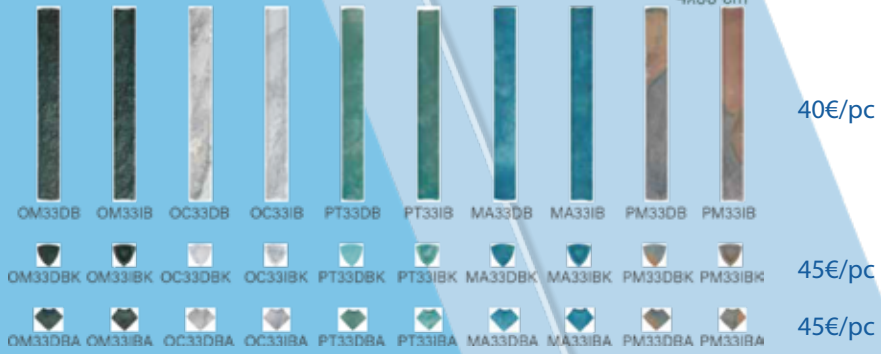

Corner Endings

4x4x33 cm

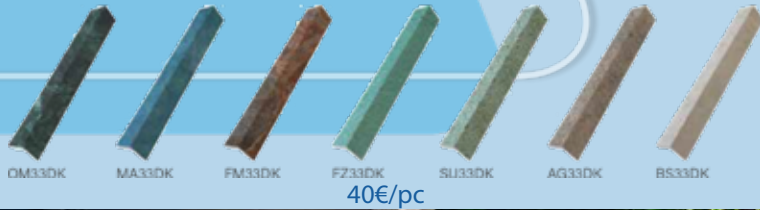

Grids

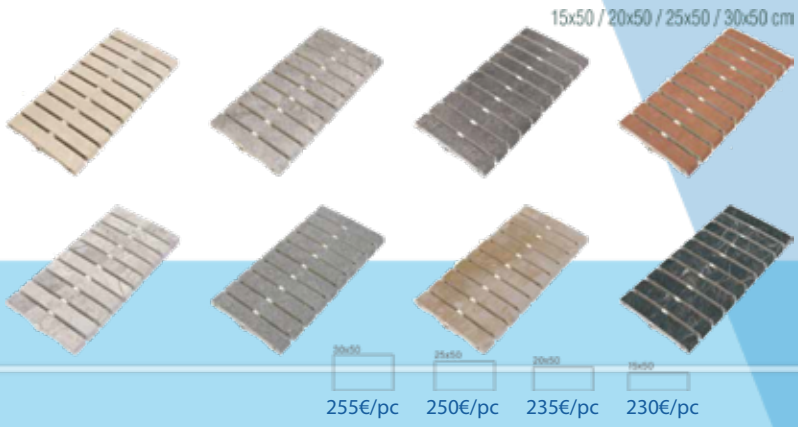

Grid Corners

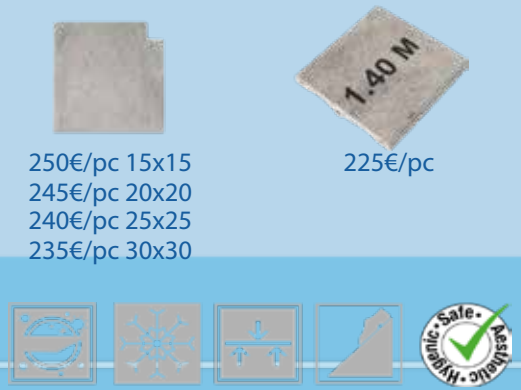

Monoblock Grid

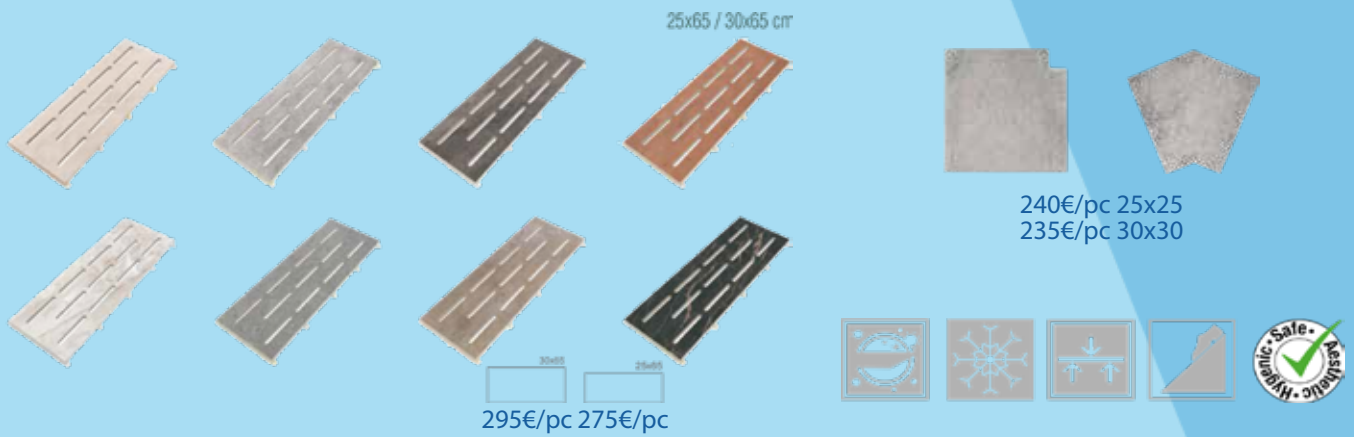



Robotic Systems / Maintenance



Eco Plus

Features:

- For pools up to 60m²
- With side brushes for cleaning the corners of the swimming pool
 - Selection between 1 or 3 working hours
- Cleaning the bottom, the walls and the water line
 - Heavy duty motor
- With waste basket easy to clean
 - 16m cable
- Suitable for all pool types

| CODE | MODEL | PRICE |
|-----------|----------|-----------|
| 103.09.93 | Eco Plus | 1,931.24€ |



APEX

With its advanced mapping algorithm and many sensors, Apex can accurately analyze the dimensions and shape of your swimming pool during the initial setup. Once the mapping process is done, Apex's navigation system will create the most optimal path to save time and energy during cleaning duties.

When tapped into its full potential with the DynaSkimmer, HexaClean Technology is able to clean every spot of your pool, including the water surface!

Features:

- Depth 0,80m - 3,00m
- Movement Speed 12 m/s
- 1 motor per wheel
- 2 Front & 2 Back Brushes
- 4.0 Liters | 180 Microns (Mesh 80)
- High-Friction Rubber Tires



| CODE | MODEL | POOL SURFACE | PRICE |
|-----------|---|--------------------|-----------|
| 103.09.33 | Apex Robot with Battery | 100 m ² | 2,990.00€ |
| 103.09.34 | Apex Robot with Battery + Skimmer | 100 m ² | 3,590.00€ |
| 103.09.35 | Apex Robot with Corded (Power Link) + Battery | 200 m ² | 3,890.00€ |
| 103.09.36 | Apex Robot with Corded (Power Link) + Battery + Skimmer | 200 m ² | 4,190.00€ |



i-Raptor

Features:

- For pools up to 200m²
- Selection between 1, 2 or 3 working hours
- Cleaning the bottom, the walls and the water line
 - 3 heavy duty motor
- With 2 easy to clean waste baskets
 - 22m cable
- Suitable for all pool types
 - With remote control
- Operated through mobile app available
 - EXTRA: trolley

| CODE | MODEL | PRICE |
|-----------|----------|-----------|
| 103.09.95 | i-Raptor | 3,135.25€ |

Crocodile Serie 5 & 8



Features:

- Bottom cleaning function, walls, water line
 - Filtration speed 18 m / l
 - Filter capacity 3.1 kg
 - 20µm cable for Serie 5
 - With Battery for Serie 8
 - For all types of pool
 - Gyroscopic pool mapping
- With transport trolley and remote control through mobile app



| CODE | MODEL | PRICE |
|-----------|------------------------------|-----------|
| 103.09.96 | Crocodile Serie 5 | 5,484.24€ |
| 103.09.97 | Crocodile Serie 8 on battery | 7,220.68€ |

Scoop 20 - Scoop 50



Features:

- **Scoop 50** bottom cleaning function, walls, water line
 - **Scoop 20** bottom cleaning function
 - Filtration speed 10 m / l
 - Filter capacity 4 kg
 - 18m cable
 - For all types of pool



AQUA POSITIONING TECHNOLOGY

| CODE | MODEL | PRICE |
|-----------|----------|-----------|
| 103.09.04 | SCOOP 20 | 5,670.00€ |
| 103.09.05 | SCOOP 50 | 6,457.50€ |



Scoop Pro 100

- Smart cleaning with integrated gyro
 - Cleans all swimming pools up to 25m wide
 - Ultra light for the user
- 2 high-strength filter bags for reliable and secure cleaning
 - Features:
 - Bottom cleaning function, walls, water line
 - Filtration speed 10 m / l
 - Filter capacity 3.1 kg
 - **Scoop Pro 100** 30m cable
- **Scoop Pro 150 XD** With battery (3h autonomy, 6h charging)
 - For all types of pool
 - Gyroscopic pool mapping
- With transport trolley and remote control through mobile app



AQUA POSITIONING TECHNOLOGY

| CODE | MODEL | PRICE |
|------------|----------------------------|-----------|
| 103.09.98 | Scoop Pro 100 | 7,510.09€ |
| 103.09.102 | Scoop Pro 150 with battery | 9,116.30€ |



Peps Series

- Brushing function multiplied via rotary brush
- Equipment is easy to use via its touch screen
- Compact, lightweight and handy robot
- Versatility of work for outstanding efficiency.
- For pools with slope less than 25 degrees.
- Features:
 - Bottom cleaning function
 - Filtration speed 10 m / l
 - Filter capacity 4 kg
 - 30m cable
 - For all types of pool
 - Gyroscopic pool mapping
- With transport trolley and remote control through mobile app



| CODE | MODEL | PRICE |
|-----------|----------|------------|
| 103.09.06 | PEPS 200 | 10,132.50€ |
| 103.09.07 | PEPS 300 | 13,282.50€ |

Scoop Pro 200 Duo

- Smart cleaning with integrated gyro
 - Cleans all swimming pools up to 50m wide
 - Ultra light for the user
- 2 high-strength filter bags for reliable and secure cleaning
 - Features:
 - Bottom cleaning function, walls, water line
 - Filtration speed 15 m / l
 - Filter capacity 6.2 kg
 - 40m cable
 - For all types of pool
 - Gyroscopic pool mapping
- With transport trolley and remote control through mobile app



AQUA POSITIONING TECHNOLOGY

| CODE | MODEL | PRICE |
|-----------|-------------------|------------|
| 103.09.85 | Scoop Pro 200 Duo | 15,888.40€ |

Standard leaf skimmer



| | |
|-------|-----------|
| CODE | 103.03.15 |
| PRICE | 10.55€ |

Economy deep dag skimmer



| | |
|-------|-----------|
| CODE | 103.03.04 |
| PRICE | 14.08€ |

Heavy duty Plastic leaf skimmer with long wearing mesh



| | |
|-------|-----------|
| CODE | 103.03.16 |
| PRICE | 14.08€ |

Heavy duty plastic leaf rake with long wearing mesh



| | |
|-------|-----------|
| CODE | 103.03.05 |
| PRICE | 21.47€ |

18" / 45cm standard curved polybristle wall brush



| | |
|-------|-----------|
| CODE | 103.04.52 |
| PRICE | 14.44€ |

18"/46cm Curved Wall Brush with alu back

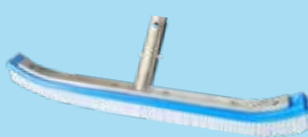

| | |
|-------|-----------|
| CODE | 103.03.43 |
| PRICE | 39.50€ |

10" / 26cm polybristle wall brush



| | |
|-------|-----------|
| CODE | 103.04.22 |
| PRICE | 10.55€ |

10"/26cm Hi-grade Stainless steel algae brush



| | |
|-------|-----------|
| CODE | 103.04.21 |
| PRICE | 21.47€ |

Flexible Vac head with pressure release Aluminum 8 wheels

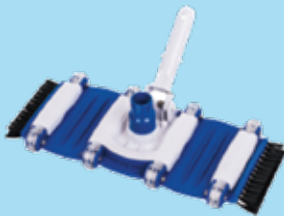

| | |
|-------|-----------|
| CODE | 103.09.67 |
| PRICE | 54.18€ |

Deluxe liner Vacuum Head with bumper (cast iron weighted)



| | |
|-------|-----------|
| CODE | 103.09.72 |
| PRICE | 32.37€ |

Flexible Vac head with pressure release and EZ-Clip



| | |
|-------|-----------|
| CODE | 103.09.66 |
| PRICE | 43.62€ |

Deluxe liner Vacuum Head with bumper and side brushes (cast iron weighted)



| | |
|-------|-----------|
| CODE | 103.09.51 |
| PRICE | 31.32€ |

Triangular Vacuum Brush



| | |
|-------|-----------|
| CODE | 103.09.65 |
| PRICE | 22,29€ |

- 2X240cm Ribbed pole 0.8mm thick
- 2X350cm Ribbed pole 1.1mm thick



| | |
|----------------|-----------|
| 2X240cm | |
| CODE | 103.05.05 |
| PRICE | 45.39€ |
| 2X350cm | |
| CODE | 103.05.02 |
| PRICE | 140.37€ |

Soft Brush Sponge



| | |
|-------|-----------|
| CODE | 103.03.42 |
| PRICE | 11.50€ |

5.75" / 14.6cm White All-Purpose Hand-Held Swimming Pool Scrub Brush



| | |
|-------|-----------|
| CODE | 103.04.23 |
| PRICE | 12.26€ |

Big Ring Floating Pool Thermometer



| | |
|-------|-----------|
| CODE | 104.19.09 |
| PRICE | 77.05€ |

Jumbo Swimming Pool Thermometer



| | |
|-------|-----------|
| CODE | 104.19.08 |
| PRICE | 10.55€ |

Basic PH / CL / Br test kit



| | |
|-------|-----------|
| CODE | 108.03.26 |
| PRICE | 10.55€ |

Ph & Cl solutions for test kits



| | |
|-------|-----------|
| CODE | 108.03.14 |
| PRICE | 6.33€ |

Swivel Cuff for vacuum hose



| | |
|-------|-----------|
| CODE | 103.01.01 |
| PRICE | 5.63€ |

Skimmer Water Lily for absorption of any oil in the water



| | |
|-------|--------|
| CODE | 207.03 |
| PRICE | 41.34€ |

Vacuum hose 1 1/2", 1m per section - 30m



| | |
|-------|-----------|
| CODE | 103.10.87 |
| PRICE | 179.00€ |

Vacuum Hose 1 1/2"



| CODE | DESCRIPTION | PRICE |
|-----------|----------------------------|--------|
| 103.10.86 | 7,5m - Vacuum Hose 1 1/2" | 49,90€ |
| 103.10.80 | 9,0m - Vacuum Hose 1 1/2" | 55,90€ |
| 103.10.84 | 12,0m - Vacuum Hose 1 1/2" | 63,50€ |
| 103.10.85 | 15,0m - Vacuum Hose 1 1/2" | 91,50€ |

- Emergency aid life hook
- Hook and handle made of durable aluminum
- Works well with standard pool pole



Life Hook

| CODE | MODEL | PRICE |
|-----------|-----------------------|---------|
| 104.18.00 | Life Hook | 113.88€ |
| 103.05.05 | Ribbed Pole 2 x 2,40m | 44.53€ |
| 103.05.02 | Ribbed Pole 2 x 3,50m | 137.70€ |

Tough outer shell resistant to oil and pool chemicals. Closed-cell with polyurethane foam core for buoyancy. Equipped with rope that floats and four reflective strips.



28" Life Ring

| CODE | MODEL | PRICE |
|-----------|----------------------|--------|
| 104.18.14 | Oxygen Life Ring 28" | 86.52€ |

Chemical dispensers



| | |
|-------|-----------|
| CODE | 103.03.40 |
| PRICE | 14,08€ |

Measuring tablets
for test kits
(10tbls / card)



| CODE | DESCRIPTION | PRICE / CARD |
|-----------|-------------|--------------|
| 108.04.08 | Phenol Red | 5.63€ |
| 108.04.07 | DPD 1 | 5.63€ |
| 108.04.02 | DPD 3 | 5.63€ |
| 108.04.00 | Cyanouric | 5.63€ |
| 108.04.03 | Iron | 13.03€ |

6-Way for:
- Total Hardness ppm
- Free chlorine ppm
- Total chlorine ppm
- Cyanuric Acid ppm
- Total Alkalinity ppm
- pH



Salt Test Stripes for
- ppm of Sodium
Chloride

| CODE | DESCRIPTION | Qty per PACK | PRICE |
|-----------|------------------|--------------|--------|
| 108.04.13 | 6Way Test Strips | 50 | 20.94€ |
| 108.04.16 | Salt Test Strips | 20 | 20.94€ |

ORP Tester



Photometer ideal for calibration of instrumentation. Narrow-band filters for high performance. Memory to encode the last 10 analyzed

| CODE | MODEL | PRICE |
|-----------|------------|---------|
| 108.01.01 | ORP tester | 333.85€ |

pH Tester

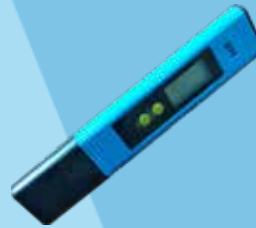

pH photometer ideal for calibration of pH dosing systems. Memory to encode the last 10 analyzed

| CODE | MODEL | PRICE |
|-----------|-----------|--------|
| 220.02.13 | pH tester | 41.88€ |

Pro-Vac OXYGON Professional Articulated Vacuum Head

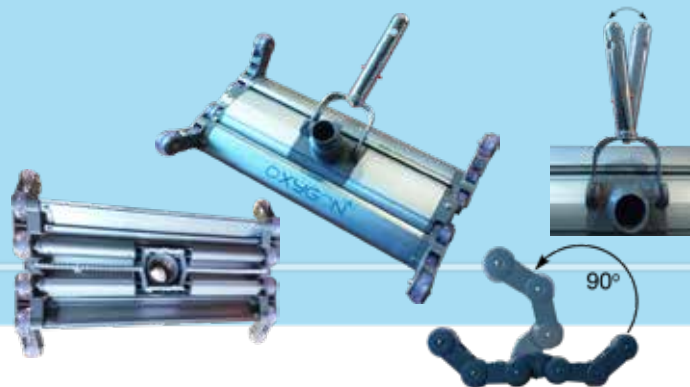

- Features:
- Aluminum Body
 - Extra large 45cm cleaning surface
 - Hydro-dynamic profile
 - 2,5kg of weight for turbulence free gliding across pool bottom
 - Swivelling connector for 1,1/2" and 2" diameter hoses
 - EZ-Clip® system for fast and easy connection with the pole

| CODE | MODEL | PRICE |
|------------|----------------|---------|
| 103.09.100 | Oxygen Pro-Vac | 199.34€ |

Cleaning Kit Standard



| CODE | INCLUDING | PRICE |
|-----------|--|---------|
| 103.09.53 | Deluxe liner Vacuum Head with bumper (cast iron weighted) * 18" / 45cm standard curved polybristle wall brush * Standard leaf skimmer * 2X240cm Ribbed pole 0.8mm thick * Extruded PE. 1 1/2" - 13m hose * Jumbo Swimming Pool Thermometer * Basic PH / CL / Br test kit | 209.37€ |

Cleaning Kit DeLuxe

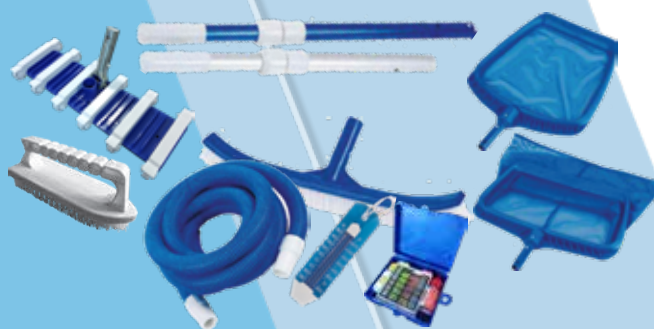

| CODE | INCLUDING | PRICE |
|-----------|---|---------|
| 103.09.54 | Heavy Duty Vac head with 12 wheels Aluminum handle plastic body (47 X 19cm) * 8" / 45cm standard curved polybristle wall brush * Heavy duty Plastic leaf skimmer with long wearing mesh * Heavy duty plastic leaf rake with long wearing mesh * 2X240cm Ribbed pole 0.8mm thick * Extruded PE. 1 1/2" - 13m hose * 5.75" / 14.6cm White All-Purpose Hand-Held Swimming Pool Scrub Brush * Jumbo Swimming Pool Thermometer * Basic PH / CL / Br test kit | 337.70€ |

Solar Shower



The outdoor shower is made of high quality ABS and PVC plastic, offering resistance to abrasion, corrosion and high temperatures. It is ideal for any type of outdoor environment such as gardens, patios or terraces. It is equipped with a large 35 Lt water tank, allowing multiple uses without the need to refill. It is easily filled with a standard garden pump through a nozzle on the back. The large 15 cm head is fully adjustable, offering the ability to direct the water jet. At the bottom there is a tap for rinsing the feet. It has a central switch for adjusting the water pressure up to 3.5 Bar and temperature adjustment, heating the water through solar energy up to 60 °C. The shower is easily placed on the floor or on a base with 4 screws included.

Construction Materials: PVC and ABS with chrome
Capacity: 35 Lt
Maximum water pressure: 3.5 Bar
Directional shower head
Switch for adjusting water pressure and temperature
Connection: via standard garden hose (adapter included)
Mounting accessories: screws and dowels (included)
Shower head diameter: 15 cm
Bottom plate dimensions: 14.5 x 18 x 0.8 cm
Overall dimensions: 16.5 x 16.5 x 220 cm

| | |
|-------|-----------|
| CODE | 103.09.36 |
| PRICE | 335.00€ |

Salt Tablets for Salt Chlorinated Systems



| | |
|------------------|-----------|
| CODE | 203.08.10 |
| PRICE / 25kg bag | 41.32€ |

Action Tablet

MultiTablets 200g



Slow-dissolving chlorine tablets for continuous and reliable disinfection.

The OXYGON Action Tablet is a broad-spectrum disinfectant designed for the sanitation of swimming pools. Its slow-release 200g tablet format ensures long-term protection, stable chlorine levels, and crystal-clear water — with minimal maintenance. Suitable for both professionals and private users, it offers maximum hygiene and effortless application.

Key Benefits

- Powerful disinfection with 99.5% Trichloroisocyanuric Acid (Symclosene)
- Slow-dissolving formula for consistent chlorine release
- Ideal for skimmers or overflow channels
- Maintains safe water balance when pH is between 7.2 – 7.6
- Long shelf life (1–3 years) and high stability during storage

Product Profile

- **Appearance:** Solid white tablets with chlorine odor
- **pH (1% solution):** 2.6–3.2
- **Water solubility (25°C):** 1.2 g/L
- **Density:** 1.9 g/cm³
- **Active ingredient:** Trichloroisocyanuric Acid 99.5% w/w
- **Packaging:** PE drums of 1, 5, 10, 20, 25, 30, or 50 kg
- **Biocide Type:** TP2

Trichloro

Slow-Dissolving Granules



Professional-grade chlorine granules for powerful, long-lasting disinfection.

OXYGON Trichloro offers a high-performance solution for the disinfection of swimming pools, combining purity, stability, and ease of use. Its slow-dissolving granular form allows for precise dosing and consistent chlorine levels, making it ideal for both professional installations and private pools. Formulated with 99.5% Trichloroisocyanuric Acid (Symclosene), it ensures broad-spectrum microbial protection, maintaining crystal-clear, safe water with minimal effort.

Key Benefits

- Powerful disinfection with slow, controlled chlorine release
- Granular format for flexible dosing and quick application
- High solubility (12 g/L at 25°C) for fast water integration
- Maintains clear, hygienic water and protects pool surfaces
- Long storage stability (1–3 years) for professional reliability

Technical Info

- **Appearance:** White solid granules, chlorine odor
- **Solubility in water (25°C):** 12 g/L
- **Melting point:** 225–240°C
- **Density:** 1.2 g/cm³
- **Active ingredient:** Trichloroisocyanuric Acid 99.5% w/w
- **Shelf life:** 1–3 years
- **Packaging:** PE drums of 1, 5, 10, 20, 25, 30, or 50 kg
- **Biocide Type:** TP2

Dichloro

Fast Action. Instant Clarity

High-efficiency chlorine for

quick disinfection and water recovery.

When your pool needs immediate attention, OXYGON Dichloro delivers fast and powerful results. Designed as a shock treatment disinfectant, it acts within just 5 minutes, effectively eliminating bacteria, fungi, and viruses. With over 55% available chlorine, it's the perfect solution for restoring water clarity after heavy use, poor chlorination, or adverse weather conditions.

Ideal for both professional and private users, this fast-dissolving granular formula ensures complete disinfection while being easy to handle and dose.



Key Benefits

- Powerful disinfection with slow, controlled chlorine release
- Granular format for flexible dosing and quick application
- High solubility (12 g/L at 25°C) for fast water integration
- Maintains clear, hygienic water and protects pool surfaces
- Long storage stability (1–3 years) for professional reliability

Technical Info

- **Appearance:** White solid granules, chlorine odor
- **Solubility in water (25°C):** 236.8 g/L
- **Active ingredient:** Sodium Dichloroisocyanurate dihydrate 100%
- **Available chlorine:** ≥55%
- **Shelf life:** 2 years
- **Biocide Type:** TP2
- **For professional and general public use**

OxyChlor Liquid

Strength in Every Drop

High-efficiency chlorine for

quick disinfection and water recovery.

Oxygon OxyChlor Liquid (NaOCl) is a high-performance biocidal disinfectant, produced through the controlled reaction of chlorine and sodium hydroxide. Its strong oxidative properties make it ideal for water disinfection, sanitation of surfaces, and treatment of wastewater systems.

With a 13% concentration of active chlorine, OxyChlor ensures effective elimination of microorganisms, odor control, and maintenance of hygienic conditions in both private and public applications.



Key Benefits

- Provides fast and reliable disinfection for swimming pools, drinking water, and industrial systems.
- Eliminates bacteria, viruses, and algae, ensuring crystal-clear, hygienic water.
- Prevents unpleasant odors caused by microbial growth.
- Versatile application for pools, surfaces, and cooling systems.
- Professional-grade formula for consistent, high-quality sanitation.

Technical Info

- **Appearance:** Liquid
- **Chemical Formula:** NaOCl
- **Concentration:** 13% active chlorine
- **Shelf Life:** 3 months at full concentration (13% active chlorine); retains 5% chlorine activity for up to 24 months
- **Color:** Pale yellow
- **Packaging:** 33kg containers
- **Odor:** Characteristic chlorine odor

Brightener

Pool Water Clarifier



Professional formula for sparkling clean, crystal-clear pool water.

When water looks dull or cloudy, OXYGON Brightener® restores the shine. Its advanced formula enhances water clarity by binding and removing the finest particles that normal filtration can't capture — leaving your pool visibly brighter and more inviting.

Developed for professional use, OXYGON Brightener® keeps pool water in perfect optical condition, ensuring a clean, sparkling appearance that enhances every swimming experience.

Key Benefits

- Enhances water clarity – restores brilliance to dull or cloudy pools
- Fast-dissolving and easy to apply
- Compatible with all pool types and filtration systems
- Ideal for regular maintenance or seasonal startup
- Professional-grade formulation for reliable results

Technical Info

- **Appearance:** Liquid
- **Color:** Blue
- **Odor:** Odorless
- **Ph:** 7.5 – 8.0
- **Shelf life:** 2 years
- **Specific Gravity:** 1.00 – 1.05 g/cm³
- **Solubility:** Fully soluble in water

Flocculant

Pool Water Clarifier & Particle Remover



Professional-grade solution for removing suspended particles and restoring water transparency.

When your pool water appears cloudy or dull, OXYGON Flocculant® goes to work. Its advanced formula binds microscopic particles together, allowing your filtration system to remove them easily. The result: clear, bright, and perfectly balanced water — just the way a pool should look.

Specially designed for professional use, OXYGON Flocculant® enhances filter performance, reduces turbidity, and keeps your water looking flawless all season long.

Key Benefits

- Eliminates cloudiness by coagulating suspended particles
- Improves filtration efficiency and water circulation
- Fast and visible results within hours
- Safe and easy to apply
- Ideal for weekly maintenance or after heavy pool usage

Technical Info

- **Appearance:** Liquid
- **Color:** Colourless
- **Odor:** Odorless
- **Ph:** 3.5 – 4.0
- **Shelf life:** 2 years
- **Specific Gravity:** 1.00 – 1.05 g/cm³
- **Solubility:** Fully soluble in water

OxyGuard Scale-X

Professional Descaler & Surface Cleaner



Removes stubborn limescale and mineral deposits quickly and effectively

Designed exclusively for professional use, OXYGUARD Scale-X is a concentrated, fast-acting cleaner that eliminates calcium build-up, limescale, and other mineral residues from pool tiles, filters, heat exchangers, and metallic or plastic surfaces.

Its balanced blend of phosphoric and hydrochloric acids ensures powerful cleaning action while minimizing effort — restoring your equipment and pool surfaces to spotless condition.

Key Benefits

- Rapid action formula – dissolves limescale and calcium deposits within minutes
- Restores surface shine and efficiency of equipment
- Ideal for filters, heat exchangers, tiles, and pool fittings
- Professional-grade strength for tough cleaning tasks
- Easy spray application with immediate visible results

Technical Info

- **Appearance:** Liquid
- **Color:** Colourless to slightly yellow
- **Odor:** Slightly acidic
- **Ph:** < 2
- **Shelf life:** 2 years
- **Specific Gravity:** 1.00 – 1.10 g/cm³
- **Solubility:** Fully soluble in water

OxyGuard Line

Pool Waterline Cleaner



Professional Care for a Cleaner, Brighter Pool

OxyGuard Line is a specialized liquid cleaner for the waterline and upper surfaces of pools. It effectively removes grease, sunscreen residues, dust, and other deposits from exposed surfaces, restoring the clean and bright appearance of liners or tiles.

Its non-foaming formula allows safe use even during pool operation, without affecting water quality. Easy to apply with immediate results, it is ideal for routine maintenance and aesthetic care of your pool.

Key Benefits

- Effectively removes grease, dirt, and sunscreen residues from waterline surfaces.
- Maintains clean and visually appealing liners and tiles.
- Non-foaming formula allows safe application during pool operation.
- Prevents unsightly stains and microbial buildup, promoting hygienic conditions.
- Easy to use with rapid and visible results.

Technical Info

- **Appearance:** Liquid
- **Color:** Blue
- **Odor:** Odourless
- **Ph:** 7.5 - 8
- **Shelf life:** 2 years
- **Specific Gravity:** 1.00 – 1.05 g/cm³
- **Solubility:** Fully soluble in water

OxyPool

Pool Water Cleaner & Whitener

Powerful Action Against Organic Impurities



OxyPool is a high-performance granular cleaner and whitener designed for swimming pools. Its powerful formulation targets organic contaminants, keeping the water clean, clear, and safe for recreational use.

The product dissolves gradually in the pool water, ensuring effective treatment throughout the circulation system.

Key Benefits

- Eliminates organic impurities, keeping pool water clear and healthy.
- Fast-acting – ready for use 30 minutes after application.
- Maintains water clarity and enhances aesthetic appearance.
- Easy to use with granular form suitable for skimmers or overflow channels.
- Compatible with regular pool filtration systems.

Technical Info

- **Appearance:** Granules
- **Color:** White
- **Odor:** Slight chlorine smell
- **Professional Use:** Recommended but safe for general users
- **Packaging:** 3 kg granules
- **Storage:** Keep dry, away from children and heat sources
- **Safety:** Follow standard pool chemical handling precautions

OxySpa

Spa Water Cleaner & Whitener

Crystal Clear SPA, Every Week



OxySpa is a specialized granular cleaner and whitener developed for spa and hot tub water care. Its advanced formula acts powerfully against organic contaminants, ensuring that the water remains clear, hygienic, and inviting at all times.

The granules dissolve gradually, releasing their active ingredients through the spa's circulation system for an even and efficient cleaning effect.

Key Benefits

- Removes organic residues and impurities from spa water.
- Keeps water crystal clear, clean, and odour-free.
- Fast-acting formula – ready for use just 30 minutes after application.
- Safe and easy to use, ideal for regular spa maintenance.
- Helps maintain water balance and extend spa equipment lifespan.

Technical Info

- **Appearance:** Granules
- **Color:** White
- **Odor:** Slight chlorine smell
- **Professional Use:** Recommended but safe for general users
- **Packaging:** 3 kg granules
- **Storage:** Keep dry, away from children and heat sources
- **Safety:** Follow standard pool chemical handling precautions

AquaBalance Plus

The Smart Way to Stabilize pH Levels

Professional Liquid pH Increaser for Swimming Pools



AquaBalance Plus Liquid is a high-performance pH increaser designed for professional pool water maintenance.

It effectively raises the pH level of swimming pool water, ensuring a perfectly balanced environment that enhances disinfection efficiency, protects pool equipment, and improves bather comfort.

Ideal for manual dosing or automatic dosing systems, AquaBalance Plus keeps your pool water in the optimal range between pH 7.2 and 7.6 — the key to crystal-clear and healthy water.

Key Benefits

- Ensures ideal pH balance for optimal chlorine efficiency.
- Prevents corrosion and scaling in pool systems.
- Enhances water clarity and swimming comfort.
- Compatible with automatic dosing systems for precise control.
- Fast-dissolving and easy to apply formula.

Technical Info

- **Form:** Liquid
- **Active Ingredient:** Sodium Hydroxide
- **Packaging:** 20 L containers (optional sizes)
- **Storage:** Keep tightly closed, in a cool, ventilated place, away from acids and heat sources.
- **Compatibility:** Suitable for all types of pool systems and dosing pumps.
- **Safety:** Causes severe skin burns and eye damage – handle with proper PPE (gloves, goggles, protective clothing).

AquaBalance Minus

Keep Your Water in Perfect Balance

Professional Liquid pH Reducer for Swimming Pools



OxyGuard AquaBalance Minus Liquid is a high-efficiency pH reducer formulated for professional pool water maintenance. It effectively lowers the pH level of swimming pool water, ensuring a balanced, healthy, and comfortable swimming environment.

Proper pH regulation enhances disinfection performance, protects filtration systems, and prevents scale formation, maintaining crystal-clear water quality throughout the season. Designed for both manual dosing and automatic control systems, AquaBalance Minus delivers precise, consistent results for optimal water balance.

Key Benefits

- Stabilizes pool chemistry by lowering high pH levels efficiently.
- Prevents scaling and mineral deposits on pool surfaces and equipment.
- Optimizes chlorine efficiency for cleaner, healthier water.
- Compatible with automatic dosing systems for precise control.
- Fast-acting liquid formula for easy and safe application.

Technical Info

- **Form:** Liquid
- **Active Ingredient:** Sulfuric Acid
- **Packaging:** 33kg containers (optional sizes)
- **Storage:** Keep tightly sealed in a cool, well-ventilated area away from incompatible substances.
- **Compatibility:** Suitable for all filtration and dosing systems.
- **Safety:** Causes severe burns and eye damage – handle with protective gloves, goggles, and clothing.

Mineral Protect

Metal-Free Clear Water

Sequestrant for Swimming Pools



OxyGuard Mineral Protect is a high-efficiency metal sequestrant formulated for professional pool water maintenance. It effectively prevents metal staining and discoloration caused by iron, copper, and manganese, ensuring pristine, crystal-clear water.

OxyGuard Mineral Protect protects pool surfaces, filtration equipment, and liner materials from corrosion and unsightly stains, maintaining water clarity and equipment longevity throughout the season.

Designed for both preventive maintenance and corrective treatment, OxyGuard Mineral Protect delivers powerful chelation action for optimal water quality and protected pool infrastructure.

Key Benefits

- Prevents red/brown stains from iron ($\text{Fe}^{2+}/\text{Fe}^{3+}$) contamination
- Prevents green stains from copper (Cu^{2+}) deposits
- Prevents black/gray stains from manganese (Mn^{2+}) oxidation
- Protects pool equipment from corrosion and degradation
- Maintains water clarity and visual transparency
- Ideal for hard water and mineral-rich regions
- Safe for all pool types and materials (vinyl, fiberglass, concrete)
- High concentration for long-term use

Technical Info

- **Form:** Liquid
- **Active Ingredient:** Hydroxyethylidene Diphosphonic Acid (HEDP)
- **Packaging:** 20 L / 25 L containers (optional sizes)
- **Storage:** Keep tightly sealed in a cool area away from oxidizing agents (chlorine)
- **Compatibility:** Safe for all filtration systems and pool materials.
- **Safety:** Causes mild to moderate skin and eye irritation – handle with protective gloves and goggles

Filter Clean

High-Performance Cleaning for Long-Lasting Filtration Systems

Deep Cleaning Power for Crystal-Clear Filtration



OxyGuard Filter Clean is the ultimate liquid cleaner for pool sand filters, designed for fast and efficient removal of scale, grease, and organic residues that accumulate between sand grains.

Its powerful active formula restores optimal filtration efficiency, improves water circulation, and helps maintain crystal-clear pool water.

Key Benefits

- Restores filtration efficiency by dissolving limescale, grease, and organic build-up trapped in the filter media.
- Extends filter lifespan, reducing the need for frequent sand or cartridge replacement.
- Improves water clarity, ensuring clean, sparkling, and odor-free pool water.
- Reduces maintenance costs through better system performance and less frequent cleaning cycles.
- Enhances water circulation, allowing your filtration system to work at full capacity.
- Easy and safe application, designed for professional use with clear dosage instructions.

Technical Info

- **Appearance:** Liquid
- **Color:** Colourless
- **Odor:** Slightly acidic
- **Ph:** < 2
- **Shelf life:** 2 years
- **Specific Gravity:** 1.10 – 1.15 g/cm^3
- **Solubility:** Fully soluble in water



OXYGON⁺

Heating / Dehumidation / Covers



Scan QR code and calculate the heat pump you need

Amelia Series

Heat Pumps for Spas & Mini Pools
3kw - 4kw - 5kw



| MODEL | | | OX03PASH005-P-MHIII | OX04PASH008-P-MHIII | OX05PASH012-P-MHIII |
|--|------------------|----------------------|---------------------|---------------------|---------------------|
| MEASURING CONDITIONS A 24° C W 26° C | HEATING CAPACITY | KW | 3,00 | 4,00 | 5,00 |
| | INPUT POWER | KW | 0,62 | 0,80 | 0,98 |
| | RUNNING CURRENT | A | 2,8 | 3,7 | 4,5 |
| | COP | | | 4,84 | 5,00 |
| POWER SUPPLY | | V/PH/HZ | 220-240V/1PH/50HZ | | |
| MAX POWER INPUT | | KW | 0,70 | 0,90 | 1,10 |
| MAX HEATING CURRENT | | A | 3,2 | 4,1 | 5,0 |
| REFRIGERANT | | | R32 | | |
| HEAT EXCHANGER | | | TITANIUM | | |
| WORKING TEMP RANGE | | | 12 - 43 °C | | |
| CASING | | | ABS + METAL | | |
| QUANTITY OF FAN | | | 1,0 | 1,0 | 1,0 |
| NOISE | | dB (A) (1 meter) | 48,0 | 49,0 | 50,0 |
| WATER CONNECTION | | mm | 32/38 | 32/38 | 32/38 |
| WATER FLOW RATE | | m3/h | 1,5 | 2,0 | 2,5 |
| NET DIMENSION | L/W/H | mm | 420/350/384 | 420/350/384 | 420/350/384 |
| PACKING DIMENSION | L/W/H | mm | 458/426/410 | 458/426/410 | 458/426/410 |
| WEIGHT | NET / GROSS | kg | 18 / 20 | 22 / 24 | 26 / 30 |
| PRICE | | | 1,004.98€ | 1,274.69€ | 1,416.63€ |



PHOENIX Series

Full Inverter / WiFi Heat Pumps
9kw - 13,2kw - 15,5kw



| MODEL | | | OX09PAS-RW020-P-BP12 | OX13PAS-RW035-P-BP12 | OX15PAS-RW040-P-BP12 |
|--|------------------|-----------|----------------------|----------------------|----------------------|
| MEASURING CONDITIONS A 27° C W 26° C | HEATING CAPACITY | KW | 2,4 - 9,0 | 3,2 - 13,2 | 4,05 - 15,5 |
| | INPUT POWER | KW | 0,30 - 1,55 | 0,38 - 2,28 | 0,50 - 2,63 |
| | COP | | | 5,80 - 10,00 | 5,80 - 10,30 |
| POWER SUPPLY | | V/PH/HZ | 220-240V/1PH/50HZ | | |
| POWER INPUT | | KW | 1,60 | 2,40 | 3,00 |
| RATING CURRENT | | A | 7,2 | 10,9 | 13,6 |
| CONTROLLER | | | LED | | |
| CONDENSER | | | Titanium | | |
| COMPRESSOR | | | Inverter | | |
| REFRIGERANT | | | R32 | | |
| QUANTITY OF FAN | | | 1,0 | | |
| NOISE | | dB (A) 1m | < 40-52 | < 42-54 | < 44-55 |
| WATER CONNECTION | | mm | Ø50 | Ø50 | Ø50 |
| WATER FLOW RATE | | m3/h | 6,5 | 9,0 | 12,0 |
| WORKING TEMPERATURE | | °C | -7°C - +43°C | -7°C - +43°C | -7°C - +43°C |
| NET DIMENSION | L/W/H | mm | 888*360*618 | | 1048*450*770 |
| WEIGHT | NET / GROSS | kg | 61 / 72 | 69 / 80 | 91 / 103 |
| PRICE | | | 4,297.80€ | 4,797.80€ | 5,922.50€ |

JAZZ Series

Full Inverter / WiFi Heat Pumps
13kw - 16kw - 20kw - 24kw



| MODEL | | | OX-LS13 | OX-LS16 | OX-LS20 | OX-LS24 |
|--|------------------|------------------|---------------|---------------|---------------|---------------|
| MEASURING CONDITIONS A 24° C W 26° C | HEATING CAPACITY | KW | 2,6 - 13 | 3,2 - 16 | 4,1 - 20 | 4,8 - 24 |
| | INPUT POWER | KW | 0,60 - 2,30 | 0,70 - 3,20 | 0,80 - 3,50 | 0,90 - 4,00 |
| | COP | | 6,4 - 13,1 | 6,4 - 13,5 | 6,4 - 13,6 | 6,4 - 14,0 |
| POWER SUPPLY | | V/PH/HZ | 220V/1PH/50HZ | | | |
| RATED POWER INPUT | | KW | 0,60 - 2,30 | 0,70 - 3,20 | 0,80 - 3,50 | 0,90 - 4,00 |
| MAX CURRENT | | A | 12 | 16,5 | 18,6 | 21 |
| RATED CURRENT | | A | 1,40 - 10,0 | 1,80 - 14,0 | 2,40 - 15,5 | 2,60 - 17,5 |
| CONTROLLER | | | LED | | | |
| CONDENSER | | | TITANIUM COIL | | | |
| REFRIGERANT | | | R32 | | | |
| QUANTITY OF FAN | | | 1,0 | | | |
| NOISE | | dB (A) (1 meter) | 42,5 - 52,0 | 42,5 - 52,0 | 44,3 - 57,0 | 44,9 - 58,7 |
| WATER CONNECTION | | mm | 50,0 | 50,0 | 50,0 | 50,0 |
| WATER FLOW RATE | | m3/h | 6 | 8 | 10 | 12 |
| WORKING TEMPERATURE | | °C | -10°C - +43°C | -10°C - +43°C | -10°C - +43°C | -10°C - +43°C |
| NET DIMENSION | L/W/H | mm | 891/370/665 | 981/370/665 | 981/440/765 | 981/440/765 |
| PACKING | L/W/H | mm | 936/385/695 | 1026/385/695 | 1026/455/800 | 1026/455/800 |
| WEIGHT | NET / GROSS | kg | 55 / 67 | 59 / 70 | 68 / 78 | 72 / 84 |
| PRICE | | | 4,797.80€ | 5,521.74€ | 6,194.56€ | 8,389.06€ |

Spark Series

Full Inverter / WiFi Heat Pumps
13kw - 17kw - 21kw - 30kw



| MODEL | | | OX-013TG1 | OX-017TG1 | OX-021TG1 | OX-030TG3 |
|--|------------------|------------------|--|---------------|---------------|-------------------|
| MEASURING CONDITIONS A 24° C W 26° C | HEATING CAPACITY | KW | 3,1 - 13,2 | 3,9 - 17,1 | 4,9 - 21 | 7,1 - 28,4 |
| | INPUT POWER | KW | 0,19 - 1,91 | 0,25 - 2,51 | 0,31 - 3,09 | 0,45 - 4,18 |
| | COP | | 6,9 - 16 | 6,8 - 15,9 | 6,8 - 15,8 | 6,8 - 15,8 |
| POWER SUPPLY | | V/PH/HZ | 220-240V/1PH/50HZ | | | 380-410V/3PH/50HZ |
| POWER INPUT | | KW | 0,26 - 1,89 | 0,34 - 2,51 | 0,43 - 3,16 | 0,56 - 4,18 |
| RATING CURRENT | | A | 9,6 | 11,9 | 14,5 | 8,4 |
| COOLING CAPACITY | | KW | 1,8 - 7,2 | 2,3 - 9,4 | 2,9 - 11,5 | 3,9 - 15,9 |
| CONTROLLER | | | LED | | | |
| CONDENSER | | | TITANIUM COIL | | | |
| REFRIGERANT | | | R32 | | | |
| QUANTITY OF FAN | | | 1,0 | 1,0 | 1,0 | 1,0 |
| NOISE | | dB (A) (1 meter) | ≤45,0 | ≤45,0 | ≤45,0 | ≤49,0 |
| WATER CONNECTION | | mm | 50,0 | 50,0 | 50,0 | 50,0 |
| WATER FLOW RATE | | m3/h | 4,5 | 5,5 | 6,5 | 9,0 |
| WORKING TEMPERATURE | | °C | -15°C - +43°C | -15°C - +43°C | -15°C - +43°C | -15°C - +43°C |
| NET DIMENSION | L/W/H | mm | 850/405/637 | 850/405/637 | 850/405/637 | 1036/448/739 |
| PACKING | L/W/H | mm | 912/435/777 | 912/435/777 | 912/435/777 | 1098/488/879 |
| WEIGHT | NET / GROSS | kg | 53 / 64 | 56 / 67 | 60 / 71 | 88 / 99 |
| FUNCTION | | | HEATING & COOLING WITH REVERSIBLE DEFROSTING | | | |
| PRICE | | | 4,797.80€ | 5,663.96€ | 6,646.51€ | 9,342.02€ |

CROSS Series

Full Inverter / WiFi Heat Pumps 13kw - 17kw - 21kw - 25kw



| MODEL | | | OX-BYC-013TH1 | OX-BYC-017TH1 | OX-BYC-021TH1 | OX-BYC-025TH1 |
|--|------------------|-----------|--|---------------|---------------|---------------|
| MEASURING CONDITIONS A 24° C W 26° C | HEATING CAPACITY | KW | 3,0 - 12,5 | 3,8 - 16,5 | 4,8 - 20,5 | 6,8 - 25 |
| | INPUT POWER | KW | 0,21 - 1,84 | 0,25 - 2,46 | 0,32 - 3,06 | 0,44 - 3,73 |
| | COP | | | 6,80 - 14,50 | 6,70 - 15,00 | 6,70 - 15,00 |
| POWER SUPPLY | | V/PH/HZ | 220V/1PH/50HZ | | | |
| POWER INPUT | | KW | 1,9 | 2,5 | 3,1 | 3,9 |
| RATING CURRENT | | A | 8,5 | 11,3 | 14,0 | 17,2 |
| COOLING CAPACITY | | KW | 1,80 - 6,50 | 2,30 - 8,20 | 2,80 - 10,20 | 3,8 - 12,5 |
| CONTROLLER | | | LED | | | |
| CONDENSER | | | Titanium | | | |
| COMPRESSOR | | | Inverter | | | |
| REFRIGERANT | | | R32 | | | |
| QUANTITY OF FAN | | | 1,0 | | | |
| NOISE | | dB (A) 1m | < 40-49 | < 41-51 | < 41-52 | < 41-52 |
| WATER CONNECTION | | mm | Ø50 | Ø50 | Ø50 | Ø50 |
| WATER FLOW RATE | | m3/h | 4,5 | 5,5 | 6,5 | 9 |
| WORKING TEMPERATURE | | °C | -15°C - +43°C | -15°C - +43°C | -15°C - +43°C | -15°C - +43°C |
| NET DIMENSION | L/W/H | mm | 900*440*620 | 1050*440*670 | 1050*440*670 | 1050*440*670 |
| PACKING DIMENSION | L/W/H | mm | 960*500*740 | 1110*500*790 | 1110*500*790 | 1110*500*790 |
| WEIGHT | NET / GROSS | kg | 55 / 65 | 63 / 73 | 68 / 78 | 88 / 98 |
| FUNCTION | | | HEATING & COOLING WITH REVERSIBLE DEFROSTING | | | |
| PRICE | | | 5,397.53€ | 7,128.57€ | 10,172.27€ | 10,827.00€ |

sun Series

Full Inverter / WiFi Heat Pumps 15kw - 18kw - 25kw - 35kw



| MODEL | | | OX-15BA1 | OX-18BA1 | OX-25BA1 | OX-35BA1 |
|--|------------------|-----------|--|-------------|--------------|--------------|
| MEASURING CONDITIONS A 24° C W 26° C | HEATING CAPACITY | KW | 3,8 - 15,0 | 4,8 - 18,0 | 6,8 - 25,0 | 8,8 - 35,0 |
| | INPUT POWER | KW | 0,24 - 2,5 | 0,30 - 3,09 | 0,43 - 4,12 | 0,56 - 5,15 |
| | COP | | | 6,8 - 15,8 | 6,8 - 15,8 | 6,8 - 15,8 |
| POWER SUPPLY | | V/PH/HZ | 220V/1PH/50HZ | | | 380V/3PH |
| POWER INPUT | | KW | 0,31 - 2,60 | 0,40 - 3,20 | 0,57 - 4,45 | 0,84 - 6,93 |
| RATING CURRENT | | A | 12 | 14,7 | 20,4 | 11,3 |
| COOLING CAPACITY | | KW | 2,1 - 9,4 | 2,7 - 11,6 | 3,8 - 14,9 | 4,9 - 19,3 |
| CONDENSER | | | Titanium | | | |
| COMPRESSOR | | | by 4 way valve | | | |
| REFRIGERANT | | | R32 | | | |
| NOISE | | dB (A) 1m | 43,0 - 55,0 | 45,0 - 56,0 | 47,0 - 58,0 | 49,0 - 59,0 |
| WATER CONNECTION | | mm | 50 | 50 | 50 | 50 |
| WATER FLOW RATE | | m3/h | 5,5 | 6,5 | 9 | 12 |
| WORKING TEMPERATURE | | °C | -15°C - +43°C | | | |
| NET DIMENSION | L/W/H | mm | 920/380/650 | | 1092/445/742 | 1080/420/740 |
| PACKING DIMENSION | L/W/H | mm | 990/440/760 | | 1150/460/862 | 1150/460/870 |
| WEIGHT | NET / GROSS | kg | 46 / 57 | 50 / 62 | 88 / 99 | 98 / 110 |
| FUNCTION | | | HEATING & COOLING WITH REVERSIBLE DEFROSTING | | | |
| PRICE | | | 5,150.00€ | 6,350.50€ | 9,050.00€ | 11,450.00€ |

VERTICAL Series

Full Inverter / WiFi Heat Pumps
21kw - 30kw - 41kw



| MODEL | | | OX-BYC-021TV1 | OX-25BA1VT | OX-BYC-035TV1 | OX-41BA1VT |
|--|------------------|-----------|-----------------|------------------|------------------|------------------|
| MEASURING CONDITIONS A 24° C W 26° C | HEATING CAPACITY | KW | 4,8 - 21,0 | 7,5 - 24,5 | 8,8 - 35 | 10,0 - 41,0 |
| | INPUT POWER | KW | 0,30 - 3,09 | 0,68 - 4,52 | 0,56 - 5,15 | 1,34 - 6,52 |
| | COP | | 6,80 - 15,80 | 5,70 - 13,10 | 6,80 - 15,80 | 5,60 - 12,80 |
| POWER SUPPLY | | V/PH/HZ | 220V/1PH/50HZ | | | 380V/3PH/50Hz |
| POWER INPUT | | KW | 3,20 | 5,17 | 6,43 | 9,58 |
| RATING CURRENT | | A | 14,7 | 23,5 | 30,0 | 13,5 |
| COOLING CAPACITY | | KW | 2,70 - 11,60 | 3,80 - 14,90 | 4,90 - 19,30 | 5,90 - 23,40 |
| CONTROLLER | | | LED | | | |
| CONDENSER | | | Titanium | | | |
| COMPRESSOR | | | Inverter | | | |
| REFRIGERANT | | | R32 | | | |
| QUANTITY OF FAN | | | 1,0 - VERTICAL | | | |
| NOISE | | dB (A) 1m | < 45-56 | < 47-58 | < 49-59 | < 47-59 |
| WATER CONNECTION | | mm | Ø50 | Ø50 | Ø50 | Ø50 |
| WATER FLOW RATE | | m3/h | 6,5 | 9,0 | 12,0 | 18,0 |
| WORKING TEMPERATURE | | °C | -15°C - +43°C | -15°C - +43°C | -15°C - +43°C | -15°C - +43°C |
| NET DIMENSION | L/W/H | mm | 650 X 650 X 770 | 730 X 730 X 980 | 715 X 715 X 955 | 730 X 730 X 980 |
| PACKING DIMENSION | L/W/H | mm | 680 X 720 X 910 | 800 X 760 X 1110 | 765 X 785 X 1080 | 800 X 760 X 1110 |
| WEIGHT | NET / GROSS | kg | 61 / 72 | 95 / 112 | 92 / 104 | 115 / 132 |
| PRICE | | | 7,485.00€ | 9,780.00€ | 11,368.35€ | 12,625.00€ |

| MODEL | | | OXWBRA-25.OH-B3-S |
|---|------------------|------------------|---|
| Working Ambient Temperature Range | | | -25°C - 43°C |
| MEASURING CONDITIONS A 24° C W 26° C | HEATING CAPACITY | KW | 24.1 |
| | INPUT POWER | KW | 4.0 |
| | RUNNING CURRENT | A | 7.16 |
| | COP | | 6.0 |
| MEASURING CONDITIONS A -15° C W 26° C | HEATING CAPACITY | KW | 9.1 |
| | INPUT POWER | KW | 3.75 |
| | RUNNING CURRENT | A | 6.7 |
| | COP | | 2.4v |
| POWER SUPPLY | | V/PH/HZ | 380-440V/3PH/50HZ |
| CONTROLLER | | | LED / LCD |
| CONDENSER | | | TITANIUM COIL |
| COMPRESSOR | | | SCROLL |
| QUANTITY OF COMPRESSORS | | | 4 |
| QUANTITY OF FAN | | | 3 |
| INPUT POWER OF FAN | | W | 240.0 X 42 |
| FAN SPEED | | RPM | 770.0 |
| NOISE | | dB (A) (1 meter) | 52.0 |
| WATER CONNECTION | | inches | 1 1/2" |
| WATER FLOW RATE | | m3/h | 11 |
| WATER PRESSURE DROP | | kpa | 20 |
| NET DIMENSION | L/W/H | mm | 2000/900/1820 |
| PACKING DIMENSION | L/W/H | mm | 2150/1020/2080 |
| WEIGHT | NET / GROSS | kg | 680/730 |
| FUNCTION | | | HEATING & COOLING WITH REVERSIBLE DEFOSTING |
| PRICE | | | 10,999.46€ |

OSLO →
Extreme Series



MACON

Commercial Series

Full Inverter / WiFi Heat Pumps 70kw - 103kw - 136kw



| MODEL | | | OXBYC-070TA1 | OXBYC-103TA1 | OXBYC-136TA1 |
|--|------------------|-----------|--|----------------|--|
| MEASURING CONDITIONS A 24° C W 26° C | HEATING CAPACITY | KW | 16,5 - 70 | 24,8 - 103 | 32,4 - 136 |
| | INPUT POWER | KW | 1,02 - 10,03 | 1,54 - 14,80 | 2,01 - 19,46 |
| | COP | | 6,98 - 16,11 | 6,96 - 16,09 | 6,99 - 16,15 |
| POWER SUPPLY | | V/PH/HZ | 380V/3PH/50HZ | | |
| POWER INPUT | | KW | 15 | 22 | 30 |
| RATING CURRENT | | A | 26 | 38 | 54 |
| COOLING CAPACITY | | KW | 14,1 - 58 | 14,1 - 58 | 18,5 - 76 |
| CONTROLLER | | | LED | LED | |
| CONDENSER | | | Titanium | Titanium | |
| COMPRESSOR | | | Inverter | Inverter | |
| REFRIGERANT | | | R32 | R32 | |
| QUANTITY OF FAN | | | 2,0 - VERTICAL | 1,0 - VERTICAL | 2,0 - VERTICAL |
| NOISE | | dB (A) 1m | <68 | <71 | <73 |
| WATER CONNECTION | | mm | Ø63 | Ø63 | Ø75 |
| WATER FLOW RATE | | m3/h | 20 | 30 | 40 |
| WORKING TEMPERATURE | | °C | -15°C - +43°C | -15°C - +43°C | -15°C - +43°C |
| NET DIMENSION | L/W/H | mm | 1416/752/1055 | 1250/1080/1870 | 2150/1080/2180 |
| PACKING | L/W/H | mm | 1580/880/1150 | 1300/1100/1950 | 2230/1120/2200 |
| WEIGHT | NET / GROSS | kg | 280 / 320 | 420 / 460 | 750 / 810 |
| FUNCTION | | | HEATING & COOLING WITH REVERSE DISCHARGE | | HEATING & COOLING WITH REVERSE DISCHARGE |
| PRICE | | | 20.229,60 € | 40.487,93 € | 49.170,12 € |

Inverack

Commercial Series

Full Inverter / WiFi Heat Pumps 60kw - 120kw



| MODEL | | | OX-INP60 | OX-INP120 |
|--|---------------|-----------|----------------|----------------------|
| MEASURING CONDITIONS A 28° C W 28° C | TURBO HEATING | KW | 60 | 120 |
| | SMART HEATING | KW | 55 | 110 |
| | INPUT POWER | KW | 2,62 - 10,71 | 5,24 - 21,43 |
| COP | | | 5,6 | 5,6 |
| POWER SUPPLY | | V/PH/HZ | 380V/3PH/50HZ | |
| RATING CURRENT | | A | 19 | 38,3 |
| CONDENSER | | | Titanium | Titanium |
| COMPRESSOR | | | Inverter | Inverter |
| REFRIGERANT | | | R410A | R410A |
| QUANTITY OF FAN | | | 1,0 - VERTICAL | 2,0 - VERTICAL |
| NOISE | | dB (A) 1m | < 44-62 | < 46-65 |
| WATER CONNECTION | | mm | Ø63 | Ø90 |
| WATER FLOW RATE | | m3/h | 15 - 20 | 20 - 35 |
| WORKING TEMPERATURE | | °C | -15°C - +43°C | -15°C - +43°C |
| NET DIMENSION | L/W/H | mm | 890*852*1492 | 1957.4*1030.5*1559.5 |
| PACKING | L/W/H | mm | 965*985*1780 | 2060*1045*1850 |
| WEIGHT | NET / GROSS | kg | 270 / 310 | 530 / 600 |
| PRICE | | | 23,264.04€ | 46,561.12€ |

Dehumidation / Αφύγρανση

Velvet Series

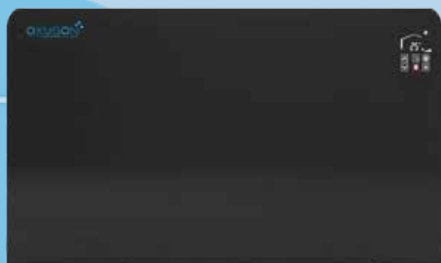

Protect your home from indoor pool moisture

By absorbing moisture from the air and converting it into warm and dry air, the heat pump dehumidifier Oxyon Velvet it can easily deal with the problems that cause condensation and corrosion of furniture. In addition, it is the perfect partner of the pool heat pump but also able to work independently to dehumidify the indoor pool area.

Pleasant air temperature

The dehumidifier Oxyon Velvet is enhanced with warm and comfortable air outlet. The unit is equipped with a hot water coil heater that can connect your own heat source such as a water tank.

Silent mode

Thanks to a new noise reduction improvement and the DC fan motor adopted for air circulation, the unit operates quietly at 44-46dB(A) and the sound is even lower than a moderate rainfall.

| MODEL | | OXPCF-2.2BD | OXPCF-3.5BD | OXPCF-4.5BD |
|---|-------------------|-----------------|--------------|--------------|
| CODE | | 750.90.05 | 750.90.06 | 750.90.07 |
| Nominal capacity 30°C ambient temperature 80% relative humidity | L / h | 2,2 | 3,5 | 4,5 |
| Possibility of dehumidification per day | L / d | 53,0 | 72,0 | 103,0 |
| Airflow (minimum speed) | m ³ /h | 220 | 300 | 350 |
| Airflow (medium speed) | m ³ /h | 350 | 400 | 500 |
| Airflow (maximum speed) | m ³ /h | 450 | 600 | 750 |
| Rated Voltage/Freq | | 220-240V / 50hz | | |
| Rated input power | kW | 0,93 | 1,33 | 1,97 |
| Rated operating current | A | 4,1 | 6,1 | 8,7 |
| Maximum input power | kW | 1,02 | 1,55 | 2,28 |
| Maximum operating current | A | 4,30 | 7,14 | 10,00 |
| Noise level | dB (A) 1m | 47 | 48 | 48 |
| Relative humidity | %RH | 40~90 | | |
| Temperature | °C | 10-36 | | |
| Coolant | | R32 | | |
| Dimensions | mm | 1288/200/678 | 1488/200/678 | 1488/200/678 |
| PRICE | | 3,937.50€ | 4,812.50€ | 5,687.50€ |

Spa Thermoregulator Heater



This heater is used in hot tub, bath and small pools and designed for continuous use with minimal pressure loss. The compact design enables installation where there is little space. The heater is made of plastic with a heating element made out of Incoloy 825, a high-alloy steel made for aggressive water. This is the 3kw version with an adjustable thermostat from 0 - 45 degrees C, overheating limit control of 60 degrees C and inbuilt flow switch.

Water temperature can be controlled +/- 2 degrees C. Maximum working pressure - 1 Bar.

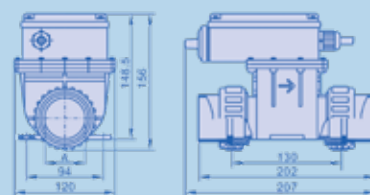

| CODE | DESCRIPTION | POWER (W) | NUMBER OF NOZZLES | OUTLET | PRICE |
|-----------|----------------------|-----------|-------------------|---------------|---------|
| 104.20.05 | SPA HEATER 220V/50Hz | 3000 | 16-32 | Ø50 or 1 1/2" | 596.99€ |

Spa Series Heaters



Features:

- Seven single-phase and one tri-phase power options ranging from 1-kW to 8-kW
- Easy installation, fully equipped and pre-wired
- Robust, durable construction
- Ultra-reliable flow switch allows safe operation
- Temperature thermostat and overheating sensor
- Analogue control with 1.2C° differential
- Titanium flow tube and titanium heating element
- Can be floor or vertically wall mounted
- Silent operation

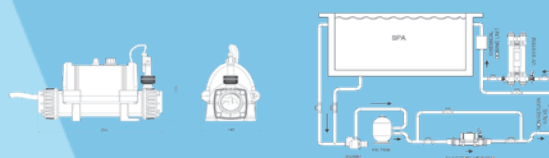

| CODE | POWER kW | AMP | MIN FLOW | MAX FLOW | INPUT | PRICE |
|------------|----------|-----|----------|----------|----------------|-----------|
| 203.11.229 | 1.0 | 5 | 1 m³/h | 17 m³/h | 220-240V / 1PH | 1,256.07€ |
| 203.11.230 | 2.0 | 9 | 1 m³/h | 17 m³/h | 220-240V / 1PH | 1,273.32€ |
| 203.11.231 | 3.0 | 13 | 1 m³/h | 17 m³/h | 220-240V / 1PH | 1,290.58€ |
| 203.11.232 | 4.0 | 18 | 1 m³/h | 17 m³/h | 220-240V / 1PH | 1,307.83€ |
| 203.11.233 | 4.5 | 20 | 1 m³/h | 17 m³/h | 220-240V / 1PH | 1,325.10€ |
| 203.11.234 | 5.0 | 22 | 1 m³/h | 17 m³/h | 220-240V / 1PH | 1,342.34€ |
| 203.11.235 | 6.0 | 27 | 1 m³/h | 17 m³/h | 220-240V / 1PH | 1,359.59€ |
| 203.11.236 | 8.0 | 20 | 1 m³/h | 17 m³/h | 380-400V / 3PH | 1,376.85€ |

Splasher Series Heaters



Features:

- Two single-phase power options at 2-kW and 3-kW
- Easy installation, fully equipped and pre-wired
- Robust, durable construction
- Ultra-reliable flow switch allows safe operation
- Temperature thermostat and overheating sensor
- Analogue control with 1.2C° differential
- Titanium flow tube and titanium heating element
- Can be floor or vertically wall mounted
- Silent operation

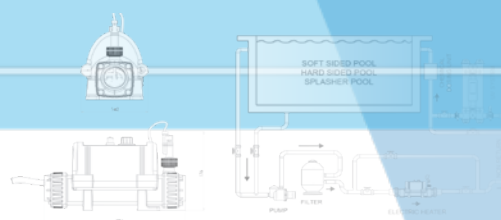

| CODE | POWER kW | AMP | MIN FLOW | MAX FLOW | INPUT | PRICE |
|------------|----------|-----|----------|----------|----------------|-----------|
| 203.11.237 | 2.0 | 9 | 1 m³/h | 17 m³/h | 220-240V / 1PH | 1,120.99€ |
| 203.11.238 | 3.0 | 13 | 1 m³/h | 17 m³/h | 220-240V / 1PH | 1,144.00€ |

Evolution2 Series Analogue & Digital Controller



Features:

- Nine single-phase power options ranging from 1kW to 24kW
- Three tri-phase power options ranging from 15kW to 24kW
- Easy installation, fully equipped and pre-wired
- Robust, durable construction
- Ultra-reliable flow switch allows safe operation
- Temperature thermostat and overheating sensor
- Analogue control with 1.2C° differential and selectable multi-lingual display
- Titanium flow tube and titanium heating element
- Can be floor or vertically wall mounted
- Silent operation

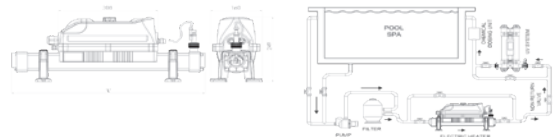

| CODE ANALOGUE | CODE DIGITAL | POWER kW | AMP | MIN FLOW | MAX FLOW | INPUT | PRICE ANALOGUE | PRICE DIGITAL |
|---------------|--------------|----------|-----|----------|----------|----------------|----------------|---------------|
| 203.11.239 | 203.11.251 | 1.0 | 6 | 1 m³/h | 17 m³/h | 220-240V / 1PH | 1,842.70€ | 2,446.57€ |
| 203.11.240 | 203.11.252 | 2.0 | 9 | 1 m³/h | 17 m³/h | 220-240V / 1PH | 1,859.94€ | 2,463.83€ |
| 203.11.241 | 203.11.253 | 3.0 | 13 | 1 m³/h | 17 m³/h | 220-240V / 1PH | 1,877.21€ | 2,481.08€ |
| 203.11.242 | 203.11.254 | 4.5 | 18 | 1 m³/h | 17 m³/h | 220-240V / 1PH | 1,894.46€ | 2,498.35€ |
| 203.11.243 | 203.11.255 | 6.0 | 27 | 1 m³/h | 17 m³/h | 220-240V / 1PH | 1,911.72€ | 2,515.59€ |
| 203.11.244 | 203.11.256 | 9.0 | 40 | 4 m³/h | 17 m³/h | 220-240V / 1PH | 2,101.51€ | 2,584.61€ |
| 203.11.245 | 203.11.257 | 12.0 | 53 | 4 m³/h | 17 m³/h | 220-240V / 1PH | 2,136.01€ | 2,826.17€ |
| 203.11.246 | 203.11.258 | 15.0 | 66 | 4 m³/h | 17 m³/h | 220-240V / 1PH | 2,446.57€ | 3,067.71€ |
| 203.11.247 | 203.11.259 | 18.0 | 79 | 4 m³/h | 17 m³/h | 220-240V / 1PH | 2,688.14€ | 3,378.28€ |
| 203.11.248 | 203.11.260 | 15.0 | 22 | 4 m³/h | 17 m³/h | 380-400V / 3PH | 2,446.57€ | 3,067.71€ |
| 203.11.249 | 203.11.261 | 18.0 | 26 | 4 m³/h | 17 m³/h | 380-400V / 3PH | 2,688.14€ | 3,378.28€ |
| 203.11.250 | 203.11.262 | 24.0 | 35 | 4 m³/h | 17 m³/h | 380-400V / 3PH | 2,791.65€ | 3,550.82€ |

Optima Series Heaters



Features:

- Eight single-phase power options from 2kW to 18kW, plus three three-phase options from 15kW to 24kW
- Easy to install, fully equipped
- Compact and durable
- Equipped with a reliable flow switch for safe operation
- Includes a thermostat and overheat sensor
- Touchscreen with soft-start function to protect the electrical supply
- Titanium flow tube and heating elements
- Can be installed horizontally or vertically on a wall
- Silent operation

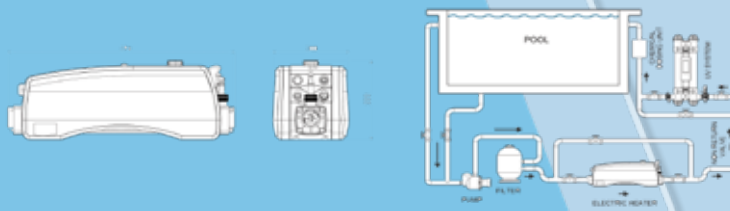

| CODE | POWER kW | AMP | MIN FLOW | MAX FLOW | INPUT | PRICE |
|------------|----------|-----|----------|----------|----------------|-----------|
| 203.11.263 | 2.0 | 9 | 1 m³/h | 17 m³/h | 220-240V / 1PH | 2,653.62€ |
| 203.11.264 | 3.0 | 13 | 1 m³/h | 17 m³/h | 220-240V / 1PH | 2,688.14€ |
| 203.11.265 | 4.5 | 20 | 1 m³/h | 17 m³/h | 220-240V / 1PH | 2,757.15€ |
| 203.11.266 | 6.0 | 27 | 1 m³/h | 17 m³/h | 220-240V / 1PH | 2,791.65€ |
| 203.11.267 | 9.0 | 40 | 4 m³/h | 17 m³/h | 220-240V / 1PH | 2,998.70€ |
| 203.11.268 | 12.0 | 53 | 4 m³/h | 17 m³/h | 220-240V / 1PH | 3,033.20€ |
| 203.11.269 | 15.0 | 66 | 4 m³/h | 17 m³/h | 220-240V / 1PH | 3,550.82€ |
| 203.11.270 | 18.0 | 79 | 4 m³/h | 17 m³/h | 220-240V / 1PH | 3,757.87€ |
| 203.11.271 | 15.0 | 22 | 4 m³/h | 17 m³/h | 380-400V / 3PH | 3,550.82€ |
| 203.11.272 | 18.0 | 26 | 4 m³/h | 17 m³/h | 380-400V / 3PH | 3,757.87€ |
| 203.11.273 | 24.0 | 35 | 4 m³/h | 17 m³/h | 380-400V / 3PH | 3,930.40€ |

Poolsmart Plus Controller



Touchscreen Heating Controller for swimming pools, comes with flow switch and temperature sensor for accurate monitoring and maintaining water temperature.

- Digital controller with 0,5C° differential
- 3 metre long temperature sensor
- 3 metre long gold tipped reed flow switch with titanium fulcrum pin
- Wall mounting
- IP 44, 240V single phase

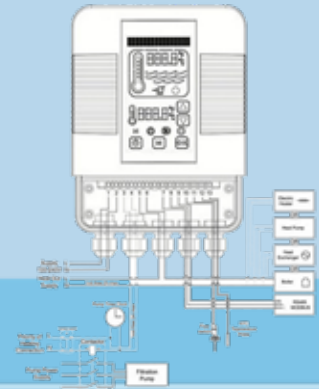

| CODE | DESCRIPTION | PRICE |
|------------|----------------------|-----------|
| 203.11.284 | PoolSmart Controller | 1,342.34€ |

Thermecro Solar Heating System



Thermecro converts a staggering 92% of solar radiation that strikes it into hot water for your swimming pool or spa. Thermecro is not reliant on outside temperatures or direct sunlight so, unlike any other solar heaters on the market, it will work optimally in all weather conditions, temperatures and locations. Ideal solution for a secondary heating device.

- Generates far more hot water per m2 than any other solar heating system
- Works even in the lowest of ambient temperatures
- Compact design in comparison to all other solar heating systems
- System is perfectly insulated so delivers hot water to the pool or spa with zero losses
- Significantly reduces your energy consumption
- Eco-Friendly reduces your carbon footprint

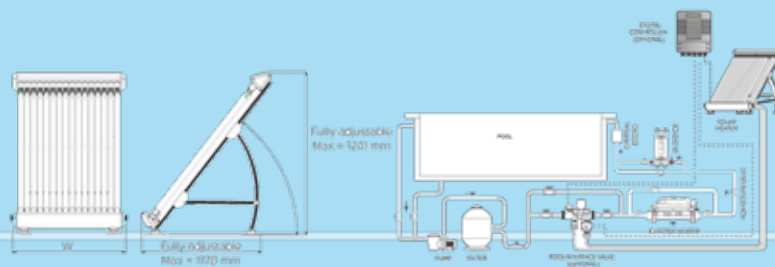

| CODE | DESCRIPTION | PRICE |
|------------|---|------------|
| 203.11.285 | Pex Pipe Plumbing Kit (30m) | 514.17€ |
| 203.11.286 | Pool Filtration Pipe Work Interface Valve | 548.66€ |
| 203.11.287 | Digital Solar Controller | 583.18€ |
| 203.11.288 | Solar Rig Adjustable Leg Kit | 1,273.32€ |
| 203.11.289 | 16 Tube Solar Array Only | 3,792.37€ |
| 203.11.290 | 16 Tube Solar Heater Complete System | 6,035.36€ |
| 203.11.291 | 32 Tube Solar Array Only | 7,070.58€ |
| 203.11.292 | 32 Tube Solar Heater Complete System | 9,313.57€ |
| 203.11.293 | 48 Tube Solar Array Only | 10,348.79€ |
| 203.11.294 | 48 Tube Solar Heater Complete System | 12,591.78€ |

D-EWT-Evo line Series Stainless Steel - Titanium

Features:

Electric heat exchangers from the D-EWT-Evo line, with control thermostat 0-40° C, safety thermostat 50° C, flow switch for low water protection and highly corrosion proof heating element made out of Incoloy 825, are extremely versatile to heat swimming pools, whirlpools, and similar facilities. To connect them to the water circuit, two new and innovative gluing sockets, D. 50, have been specifically developed. The flow switch needs to be screwed into one of the two gluing sockets. This way, the flow switch can be positioned at the entrance or the exit of the heat exchanger. Another advantage is that during maintenance or repair, the flow switch doesn't have to be removed and is protected in the piping. They work perfectly for permanent and mobile facilities. You can expect product longevity if the safety and installation instructions are closely followed.



| KW | A | B | C | D | E | F |
|------|-------|-----|-------|-------|-------|-------|
| 1,5 | 293mm | Ø50 | 345mm | 475mm | 110mm | 255mm |
| 3,0 | 293mm | Ø50 | 345mm | 475mm | 110mm | 255mm |
| 6,0 | 363mm | Ø50 | 415mm | 545mm | 110mm | 255mm |
| 9,0 | 363mm | Ø50 | 415mm | 545mm | 110mm | 260mm |
| 12,0 | 453mm | Ø50 | 505mm | 635mm | 110mm | 260mm |
| 15,0 | 553mm | Ø50 | 605mm | 735mm | 110mm | 270mm |
| 18,0 | 653mm | Ø50 | 705mm | 835mm | 110mm | 270mm |

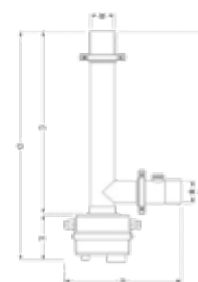

| CODE Stainless Steel | CODE Titanium | POWER kW | INPUT | AMP | PUMP CAPACITY | MAX PRESSURE | PRICE Stainless Steel | PRICE Titanium |
|-------------------------|------------------|-------------|------------|------|------------------|-----------------|--------------------------|-------------------|
| 203.11.295 | - | 1.5 | 240V / 1PH | 6,6 | 2,8 m³/h | 3 bar | 1.213,38 € | - |
| 203.11.296 | - | 1,5 | 400V / 3PH | 2,2 | 2,8 m³/h | 3 bar | 1.213,38 € | - |
| 203.11.297 | 203.11.305 | 3,0 | 240V / 1PH | 12,9 | 2,8 m³/h | 3 bar | 1.230,10 € | 1.433,99 € |
| 203.11.298 | 203.11.306 | 3,0 | 400V / 3PH | 4,3 | 2,8 m³/h | 3 bar | 1.230,10 € | 1.433,99 € |
| 203.11.299 | 203.11.307 | 6,0 | 240V / 1PH | 26,1 | 2,8 m³/h | 3 bar | 1.293,60 € | 1.467,42 € |
| 203.11.300 | 203.11.308 | 6,0 | 400V / 3PH | 8,7 | 2,8 m³/h | 3 bar | 1.293,60 € | 1.467,42 € |
| 203.11.301 | 203.11.309 | 9,0 | 400V / 3PH | 13,0 | 2,8 m³/h | 3 bar | 1.320,34 € | 1.534,27 € |
| 203.11.302 | 203.11.310 | 12,0 | 400V / 3PH | 17,3 | 2,8 m³/h | 3 bar | 1.330,37 € | 1.567,70 € |
| 203.11.303 | - | 15,0 | 400V / 3PH | 21,7 | 2,8 m³/h | 3 bar | 1.350,43 € | - |
| 203.11.304 | 203.11.311 | 18,0 | 400V / 3PH | 26,0 | 2,8 m³/h | 3 bar | 1.393,89 € | 1.734,83 € |

D-EWT-Economy line Series Stainless Steel

Features:

Electric heat exchangers from the D-EWT Economy line with control thermostat 0-40° C, safety thermostat 50° C, featuring a pressure switch for low water protection and highly corrosion proof heating element, made out of Incoloy 825, are very cost-effective without limiting functionality and quality. They are extremely versatile – for heating swimming pools, whirlpools and similar facilities. They work perfectly for permanent and mobile facilities. The electric heat exchanger is easily and simply connected to the water circuit with the handy gluing socket D50. You can expect product longevity if the safety and installation instructions are closely followed.



| KW | A | B | C | D | E | F |
|------|-------|-----|-------|-------|-------|-------|
| 1,5 | 293mm | Ø50 | 345mm | 475mm | 110mm | 240mm |
| 3,0 | 293mm | Ø50 | 345mm | 475mm | 110mm | 240mm |
| 6,0 | 363mm | Ø50 | 415mm | 545mm | 110mm | 240mm |
| 9,0 | 363mm | Ø50 | 415mm | 545mm | 110mm | 240mm |
| 12,0 | 453mm | Ø50 | 505mm | 635mm | 110mm | 240mm |
| 15,0 | 553mm | Ø50 | 605mm | 735mm | 110mm | 240mm |
| 18,0 | 653mm | Ø50 | 705mm | 835mm | 110mm | 240mm |

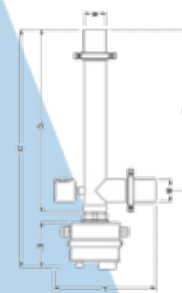

| CODE | POWER kW | INPUT | AMP | PRESSURE SWITCH ON | PRESSURE SWITCH OFF | MAX PRESSURE | SHELL MATERIAL | PRICE |
|------------|----------|------------|------|-----------------------|------------------------|-----------------|-------------------|----------|
| 203.11.312 | 1.5 | 240V / 1PH | 6,6 | 0,1 bar | 0,06 bar | 3 bar | AISI 316 | 818,95 € |
| 203.11.313 | 1,5 | 400V / 3PH | 2,2 | 0,1 bar | 0,06 bar | 3 bar | AISI 316 | 818,95 € |
| 203.11.314 | 3,0 | 240V / 1PH | 12,9 | 0,1 bar | 0,06 bar | 3 bar | AISI 316 | 832,32 € |
| 203.11.315 | 3,0 | 400V / 3PH | 4,3 | 0,1 bar | 0,06 bar | 3 bar | AISI 316 | 832,32 € |
| 203.11.316 | 6,0 | 240V / 1PH | 26,1 | 0,1 bar | 0,06 bar | 3 bar | AISI 316 | 852,38 € |
| 203.11.317 | 6,0 | 400V / 3PH | 8,7 | 0,1 bar | 0,06 bar | 3 bar | AISI 316 | 852,38 € |
| 203.11.318 | 9,0 | 400V / 3PH | 13,0 | 0,1 bar | 0,06 bar | 3 bar | AISI 316 | 865,74 € |
| 203.11.319 | 12,0 | 400V / 3PH | 17,3 | 0,1 bar | 0,06 bar | 3 bar | AISI 316 | 899,17 € |
| 203.11.320 | 15,0 | 400V / 3PH | 21,7 | 0,1 bar | 0,06 bar | 3 bar | AISI 316 | 932,60 € |
| 203.11.321 | 18,0 | 400V / 3PH | 26,0 | 0,1 bar | 0,06 bar | 3 bar | AISI 316 | 966,02 € |

D-EWT-Neo line Series Incoloy & Titanium

Features:

The electric heat exchanger, from the series D-EWT-NEO, consists of a pressure resistant shell, made out of nonflammable plastic, which makes it suitable as electro technical product. All the other components are well thought through and made out of first class materials. It comes equipped triple protected, with control thermostat 0-40°C, safety thermostat 50°C, and flow switch as low water protection, as well as two wall mounts. The heating elements are either Incoloy 825 or titanium. The titanium heating elements are totally corrosion resistant and therefore also suitable for sea water. The electric heat exchanger is extremely versatile for heating swimming pools, whirlpools and similar facilities. It works perfectly for permanent and mobile facilities. It is easily and simply connected to the water circuit with the handy gluing socket D50. You can expect product longevity if the safety and installation instructions are closely followed.

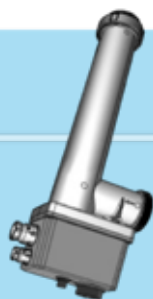

| KW | A | B | C | D |
|------|-------|-----|-------|-------|
| 1,5 | 287mm | Ø50 | 465mm | 260mm |
| 3,0 | 287mm | Ø50 | 465mm | 260mm |
| 6,0 | 357mm | Ø50 | 535mm | 260mm |
| 9,0 | 357mm | Ø50 | 535mm | 264mm |
| 12,0 | 547mm | Ø50 | 725mm | 264mm |
| 15,0 | 547mm | Ø50 | 725mm | 270mm |
| 18,0 | 547mm | Ø50 | 82mm | 270mm |

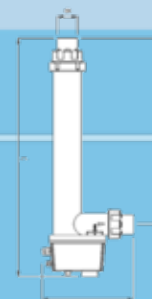

| CODE Incoloy | CODE Titanium | POWER kW | INPUT | AMP | PUMP CAPACITY | MAX PRESSURE | SHELL MATERIAL | PRICE Incoloy | PRICE |
|--------------|---------------|----------|------------|------|---------------|--------------|----------------|---------------|------------|
| 203.11.322 | - | 1.5 | 240V / 1PH | 6,6 | 3 m³/h | 2,5 bar | PP30% Fg,FR | 568,25 € | - |
| 203.11.323 | - | 1,5 | 400V / 3PH | 2,2 | 3 m³/h | 2,5 bar | PP30% Fg,FR | 568,25 € | - |
| 203.11.325 | 203.11.333 | 3,0 | 240V / 1PH | 12,9 | 3 m³/h | 2,5 bar | PP30% Fg,FR | 581,63 € | 966,02 € |
| 203.11.326 | 203.11.334 | 3,0 | 400V / 3PH | 4,3 | 3 m³/h | 2,5 bar | PP30% Fg,FR | 581,63 € | 966,02 € |
| 203.11.327 | 203.11.335 | 6,0 | 240V / 1PH | 26,1 | 3 m³/h | 2,5 bar | PP30% Fg,FR | 598,33 € | 999,45 € |
| 203.11.328 | 203.11.336 | 6,0 | 400V / 3PH | 8,7 | 3 m³/h | 2,5 bar | PP30% Fg,FR | 598,33 € | 999,45 € |
| 203.11.329 | 203.11.337 | 9,0 | 400V / 3PH | 13,0 | 3 m³/h | 2,5 bar | PP30% Fg,FR | 615,04 € | 1.066,31 € |
| 203.11.330 | 203.11.338 | 12,0 | 400V / 3PH | 17,3 | 3 m³/h | 2,5 bar | PP30% Fg,FR | 665,18 € | 1.099,73 € |
| 203.11.331 | - | 15,0 | 400V / 3PH | 21,7 | 3 m³/h | 2,5 bar | PP30% Fg,FR | 688,59 € | - |
| 203.11.332 | 203.11.339 | 18,0 | 400V / 3PH | 26,0 | 3 m³/h | 2,5 bar | PP30% Fg,FR | 722,01 € | 1.233,43 € |

Dual line Series

Features:

With this innovative dual heat exchanger you can heat up bathing water by either using the heating element or by exchanging heat through the coiled tube. It can also be operated with both systems at the same time which raises the capacity considerably. Use your preferred energy source and add the other one when needed. It is equipped (standard) with a flow switch for low water protection, a safety thermostat 55°C, and with a highly corrosion resistant heating element Incoloy 800. It is easily and simply connected to the water circuit with a gluing socket D50. It is made to save space and it's perfectly suited for whirlpools, fish tanks, and similar small facilities. To ensure product longevity, like for all heat exchangers, we carefully use high quality materials and guarantee first class workmanship.



| A | B | C | D | E | F |
|-------|-------|-------|-----|-------------|-----------|
| 435mm | 200mm | 220mm | Ø50 | 3/4" female | 3/4" male |

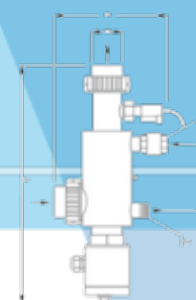

| CODE | POWER kW | INPUT | AMP | PRIMARY FLOW | SECONDARY FLOW | MAX PRESSURE PRIMARY | MAX PRESSURE SECONDARY | PRICE |
|------------|----------|------------|------|--------------|----------------|----------------------|------------------------|------------|
| 203.11.348 | 2 | 240V / 1PH | 8,8 | 0,9 m³/h | 6 m³/h | 3 bar | 10 bar | 1.166,58 € |
| 203.11.349 | 3 | 240V / 1PH | 12,9 | 0,9 m³/h | 6 m³/h | 3 bar | 10 bar | 1.200,01 € |
| 203.11.350 | 5 | 240V / 1PH | 21,5 | 0,9 m³/h | 6 m³/h | 3 bar | 10 bar | 1.233,43 € |
| 203.11.351 | 3 | 400V / 3PH | 4,3 | 0,9 m³/h | 6 m³/h | 3 bar | 10 bar | 1.266,86 € |

X-EWT-2.0 Smart line Series

The X-EWT 2.0 is a highly safe device with reduced vulnerability to its electric components. The shell is pressure resistant and made out of non-flammable plastic. The heating elements and the controller are separated through a "two chamber system". This offers the advantage that if water or humidity penetrates into the first chamber (heating elements), the controller (second chamber) won't be destroyed. The heating elements are made out of highly corrosion resistant stainless steel, Incoloy 825 or with MagnaCoat® coating (seawater proof), and are connected with a flange through TIG welding. They are cabled together to a 3-phase heating element 400V and enable the controlling of the heating element solely through an operating contactor and a safety contactor. In case of damage, it is guaranteed that the heat exchanger will switch off thanks to the safety contactor. Three safety thermostats, set at 55°C, ensure the shutdown of the device if it is overheated. A safety thermostat and a pressure switch prevent the operation when there is a shortage of water. This is a compact, very versatile, electric heat exchanger and it can be operated as a mounted or a mobile device. It can be directly connected to the bathing water circuit through a PVC flange pipe DN63 or through the bypass system



| A | B | C | D | E |
|-------|-------|-------|-----|-------|
| 924mm | 561mm | 374mm | Ø63 | 253mm |

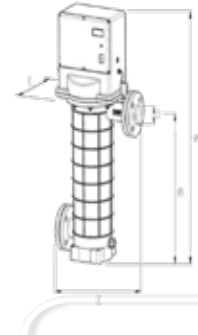

| CODE | POWER kW | INPUT | AMP | MAX TEMP | WATER | MIN FLOW | MAX FLOW | SHELL MATERIAL | PRICE |
|------------|----------|-------|-----|----------|------------|----------|----------|----------------|------------|
| 203.11.340 | 36 | 400V | 52 | 40°C | Chlorine | 12 m³/h | 25 m³/h | PA66% Fg.FR | 5.010,62 € |
| 203.11.341 | 36 | 400V | 52 | 40°C | Salt Water | 12 m³/h | 25 m³/h | PA66% Fg.FR | 6.347,68 € |
| 203.11.342 | 45 | 400V | 64 | 40°C | Chlorine | 12 m³/h | 25 m³/h | PA66% Fg.FR | 5.344,89 € |
| 203.11.343 | 45 | 400V | 64 | 40°C | Salt Water | 12 m³/h | 25 m³/h | PA66% Fg.FR | 7.350,48 € |
| 203.11.344 | 54 | 400V | 78 | 40°C | Chlorine | 12 m³/h | 25 m³/h | PA66% Fg.FR | 5.679,15 € |
| 203.11.345 | 54 | 400V | 78 | 40°C | Salt Water | 12 m³/h | 25 m³/h | PA66% Fg.FR | 8.019,00 € |
| 203.11.346 | 72 | 400V | 104 | 40°C | Chlorine | 12 m³/h | 25 m³/h | PA66% Fg.FR | 6.681,94 € |
| 203.11.347 | 72 | 400V | 104 | 40°C | Salt Water | 12 m³/h | 25 m³/h | PA66% Fg.FR | 9.356,05 € |

Electric Heaters Contactor Control

contactor control
1,5 - 12 kW
15 - 18 kW
24 kW



The contactor controls for electric heat exchangers are wired and enable a professional and straightforward operation of electric heat exchangers. The control lamp comes standard. Three different models are available as a wall mounting system from 1,5-12 kW, 15-18 kW or 24 kW for the models of the series Classic, Evo, Full titanium, Economy and Neo. To ensure a correct function of the electric heat exchanger, please carefully follow the wiring diagram.

| CODE | MODEL | MAX. USAGE | VOLTAGE | MAX CURRENT | PRICE |
|------------|-------------|------------|----------|-------------|----------|
| 203.11.352 | 1,5 - 12 kW | 12kW | 230/400V | 30A | 665,18 € |
| 203.11.353 | 15 - 18 kW | 18kW | 230/400V | 45A | 732,04 € |
| 203.11.354 | 24 kW | 24kW | 230/400V | 50A | 865,74 € |

G2 Multitubular Heat Exchanger



Features:

- Four models ranging from 30-kW to 122-kW
 - Titanium tube bundle
- BS 316L Stainless Steel primary casing
 - Salt and sea water compatible
 - 4 bar pressure tolerance
 - Low pressure drop
- Temperature and flow sensor port
- Floor or wall mountable

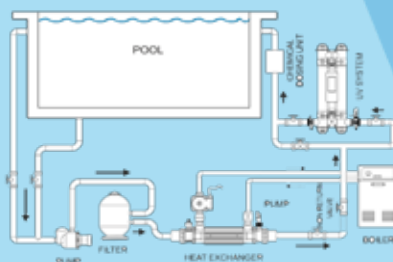
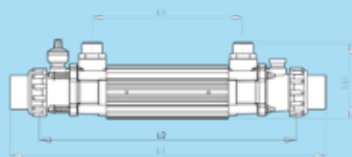

| MODEL | L1 | L2 | L3 |
|------------|--------|-------|-------|
| G2-HE-30T | 540mm | 426mm | 247mm |
| G2-HE-49T | 710mm | 596mm | 417mm |
| G2-HE-85T | 840mm | 726mm | 547mm |
| G2-HE-122T | 1000mm | 886mm | 707mm |

| CODE | MODEL | STANDART OUTPUT kW | PRIMARY FLOW m ³ /h | PRIMARY PRESSURE LOSS bar | SECONDARY FLOW m ³ /h | SECONDARY PRESSURE LOSS bar | PRICE |
|-----------|------------|--------------------|--------------------------------|---------------------------|----------------------------------|-----------------------------|-----------|
| 203.11.80 | G2-HE-30T | 30 | 1.1 | 0.061 | 10 | 2.0 | 1,204.31€ |
| 203.11.61 | G2-HE-49T | 49 | 1.6 | 0.077 | 16 | 2.0 | 1,549.39€ |
| 203.11.62 | G2-HE-85T | 85 | 2.4 | 0.113 | 17 | 2.0 | 1,756.43€ |
| 203.11.63 | G2-HE-122T | 122 | 3.8 | 0.183 | 19 | 2.0 | 2,481.08€ |

SST Shell & Spiral Tube Heat Exchanger

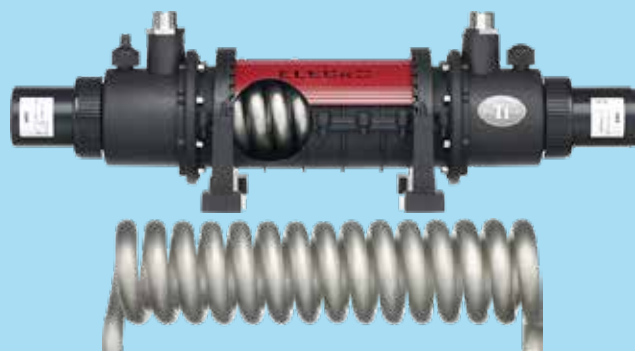

Features:

- Four models ranging from 36-kW to 95-kW
 - Special formulated polymer
 - Coiled titanium primary casing
 - Salt and sea water compatible
- 30 bar (primary) and 3 bar (secondary) pressure tolerance
 - Low pressure drop
- With optional Smart Touchscreen Controller & Booster Pump
 - Temperature and flow sensor port
 - Floor or wall mountable

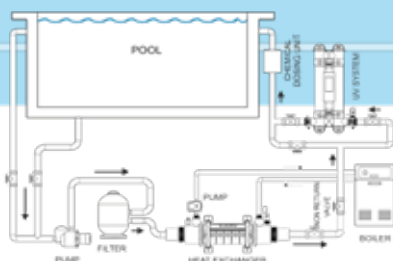
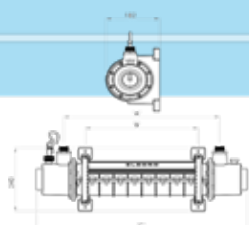

| MODEL | A | B | C |
|--------|-------|-------|-------|
| SST-36 | 290mm | 143mm | 478mm |
| SST-50 | 386mm | 240mm | 574mm |
| SST-75 | 530mm | 384mm | 718mm |
| SST-95 | 674mm | 528mm | 862mm |

| CODE | MODEL | STANDART OUTPUT kW | PRIMARY FLOW m ³ /h | PRIMARY PRESSURE LOSS bar | SECONDARY FLOW m ³ /h | SECONDARY PRESSURE LOSS bar | PRICE |
|-----------|--------|--------------------|--------------------------------|---------------------------|----------------------------------|-----------------------------|-----------|
| 203.11.64 | SST-36 | 36 | 1.1 | 0.061 | 12 | 0.050 | 1,311.44€ |
| 203.11.65 | SST-50 | 50 | 2.5 | 0.068 | 15 | 0.050 | 1,687.03€ |
| 203.11.66 | SST-75 | 75 | 2.7 | 0.068 | 18 | 0.070 | 2,187.82€ |
| 203.11.67 | SST-95 | 95 | 3.2 | 0.077 | 18 | 0.092 | 2,813.81€ |

Escalade Heat Exchanger

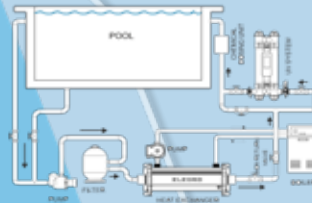
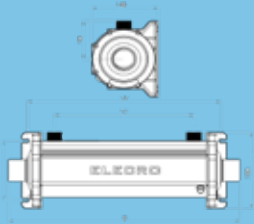
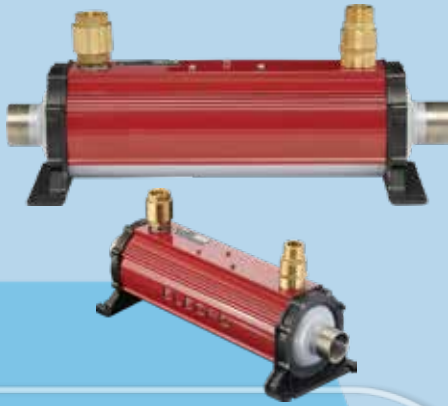

Features:

- Three models ranging from 30-kW to 75-kW
- High efficiency, titanium spiral coil is fully immersed in the secondary chamber
 - Coiled grade 1 titanium primary casing
 - Salt and sea water compatible
- 30 bar (primary) and 5 bar (secondary) pressure tolerance
 - Low pressure drop
- With optional Smart Touchscreen Controller and Booster Pump
 - Temperature and flow sensor port
 - Floor or wall mountable

| MODEL | A | B | C |
|--------|-------|-------|-------|
| WHE-30 | 382mm | 476mm | 262mm |
| WHE-40 | 430mm | 515mm | 310mm |
| WHE-75 | 674mm | 759mm | 554mm |

| CODE | MODEL | STANDART OUTPUT | PRIMARY FLOW m ³ /h | PRIMARY PRES-SURE LOSS bar | SECONDARY FLOW m ³ /h | SECONDARY PRES-SURE LOSS bar | PRICE |
|-----------|--------|-----------------|--------------------------------|----------------------------|----------------------------------|------------------------------|-----------|
| 203.11.68 | WHE-30 | 30kW (102k BTU) | 1.1 | 0.061 | 12 | 0.05 | 1,342.74€ |
| 203.11.69 | WHE-40 | 40kW (136k BTU) | 2.4 | 0.068 | 15 | 0.05 | 1,593.13€ |
| 203.11.70 | WHE-75 | 75kW (256k BTU) | 3.0 | 0.068 | 18 | 0.07 | 1,843.52€ |

HeatSmart / CoolSmart PLUS



Touchscreen Heating or Cooling Controller for heat exchanger, comes with flow switch and temperature sensor and as an option with booster pump.

Features:

- Smart touchscreen display
- BMS (Building Management System) Integration Ready
- Multi-lingual interface
- Programmable 24-hour time clock (4 time zones)
 - Flow and temperature sensor ports
 - Accurate control to 0.5°C
 - Diagnostic display

| CODE | MODEL | DESCRIPTION | PRICE |
|-----------|------------|--|-----------|
| 203.11.71 | PSPC-HE | Pool Smart Heating PLUS Touch Screen, with 1m Flow Switch, 1m Temp Sensor 10W, 220V, 50/60HZ | 1,092.35€ |
| 203.11.72 | PSPC-HE-GP | Pool Smart Heating PLUS Touch Screen, with 1m Flow Switch, 1m Temp Sensor & Grundfos Booster Pump 90W, 220V, 50/60HZ | 1,530.54€ |
| 203.11.73 | KSPC-HE | Pool Smart Cooling PLUS Touch Screen, with 1m Flow Switch, 1m Temp Sensor 10W, 220V, 50/60HZ | 1,092.35€ |
| 203.11.74 | KSPC-HE-GP | Pool Smart Cooling PLUS Touch Screen, with 1m Flow Switch, 1m Temp Sensor & Grundfos Booster Pump 90W, 220V, 50/60HZ | 1,530.54€ |

D-HWT High Temperature Series



Features smooth coiled tubing in cross flow, with inner shell and baffle plate for optimal primary energy intake or without inner shell baffle plate, state of the art welding and top quality processing. Longevity of the device is guaranteed thanks to the finishing of the material through staining, passivation and external electropolishing. These heat exchangers offer maximum energy efficiency at minimal pressure loss. Like all coiled tubing heat exchangers, they must be integrated directly in the water circuit of the pool or through the bypass system

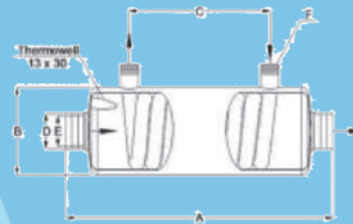
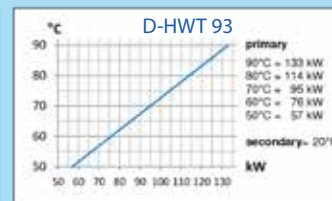
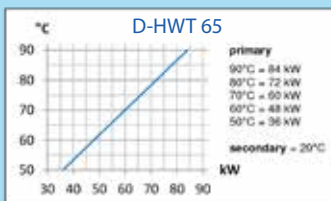
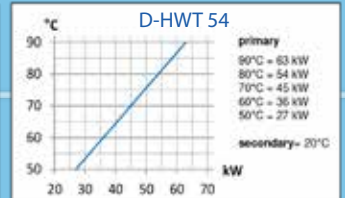
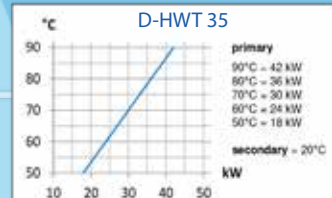
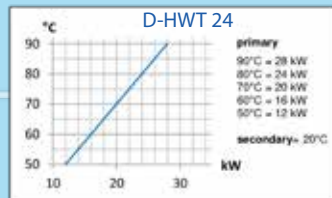
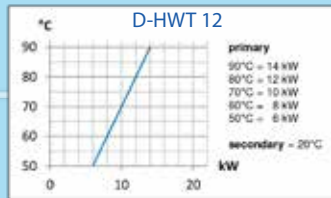

| MODEL | A | B | C | D | E | F |
|----------|-------|-------|-------|------|------------|-----------|
| D-HWT 12 | 250mm | 125mm | 90mm | 50mm | 1 1/2" fem | 3/4" male |
| D-HWT 24 | 320mm | 125mm | 165mm | 50mm | 1 1/2" fem | 3/4" male |
| D-HWT 35 | 385mm | 125mm | 205mm | 50mm | 1 1/2" fem | 3/4" male |
| D-HWT 54 | 580mm | 125mm | 410mm | 50mm | 1 1/2" fem | 1" male |
| D-HWT 65 | 680mm | 125mm | 495mm | 50mm | 1 1/2" fem | 1" male |
| D-HWT 93 | 780mm | 160mm | 590mm | 63mm | 2" fem | 1" male |

| CODE | MODEL | HEAT CAPACITY kW (90°C) | PRIMARY FLOW m³/h | PRIMARY PRES-SURE LOSS bar | SECONDARY FLOW m³/h | SECONDARY PRESURE LOSS bar | PRICE |
|-----------|----------|-------------------------|-------------------|----------------------------|---------------------|----------------------------|-----------|
| 203.11.75 | D-HWT 12 | 14 | 1.2 | 0.03 | 10 | 0.05 | 770.22€ |
| 203.11.76 | D-HWT 24 | 28 | 1.8 | 0.11 | 12 | 0.06 | 843.93€ |
| 203.11.77 | D-HWT 35 | 42 | 2.0 | 0.18 | 10 | 0.10 | 917.67€ |
| 203.11.78 | D-HWT 54 | 63 | 3.0 | 0.11 | 12 | 0.16 | 1,175.64€ |
| 203.11.79 | D-HWT 65 | 84 | 3.0 | 0.23 | 12 | 0.22 | 1,433.62€ |
| 203.11.60 | D-HWT 93 | 133 | 4.0 | 0.44 | 15 | 0.22 | 2,207.55€ |

type D-HWT 122



type D-HWT 182

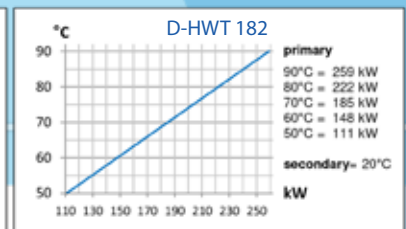
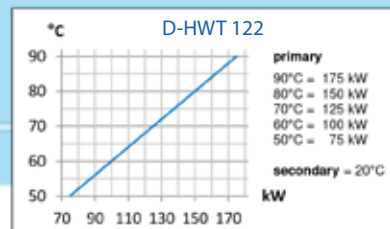

| MODEL | A | B | C | D | E | F |
|-----------|--------|-------|-------|------|--------|---------|
| D-HWT 122 | 1050mm | 160mm | 370mm | 63mm | 2" fem | 1" male |
| D-HWT 182 | 1370mm | 160mm | 530mm | 63mm | 2" fem | 1" male |

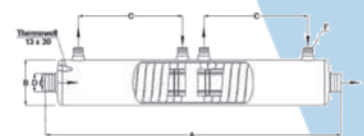

| CODE | MODEL | HEAT CAPACITY kW (90°C) | PRIMARY FLOW m³/h | PRIMARY PRES-SURE LOSS bar | SECONDARY FLOW m³/h | SECONDARY PRESURE LOSS bar | PRICE |
|-----------|-----------|-------------------------|-------------------|----------------------------|---------------------|----------------------------|-----------|
| 203.11.81 | D-HWT 122 | 175 | 2 X 4.0 | 0.27 | 20 | 0.5 | 2,944.64€ |
| 203.11.82 | D-HWT 182 | 259 | 2 X 4.3 | 0.5 | 25 | 0.8 | 3,644.86€ |

D-NWT 18 & 35 Low Temperature

Low temperature 30/60 kW at 50°C stainless steel.



Features smooth coiled tubing in cross flow, with inner shell and baffle plate for optimal primary energy intake, state of the art welding and top quality processing. Longevity of the device is guaranteed thanks to the finishing of the material through staining, passivation and external electropolishing. These heat exchangers offer maximum energy efficiency at minimal pressure loss. Like all coiled tubing heat exchangers, they must be integrated directly in the water circuit of the pool or through the bypass system

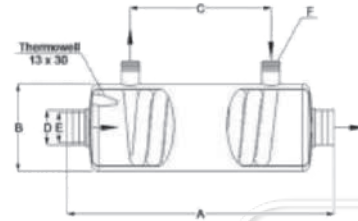
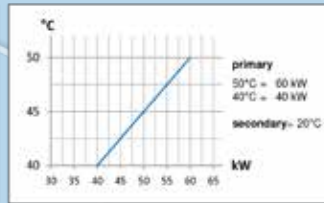
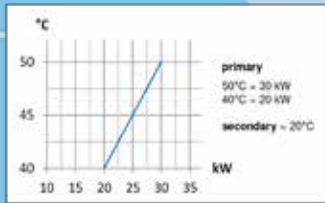

| MODEL | A | B | C | D | E | F |
|----------|--------|-------|-------|------|------------|---------|
| D-NWT 18 | 680mm | 125mm | 495mm | 50mm | 1 1/2" fem | 1" male |
| D-NWT 35 | 1050mm | 160mm | 820mm | 50mm | 1 1/2" fem | 1" male |

| CODE | MODEL | HEAT CAPACITY kW (90°C) | PRIMARY FLOW m³/h | PRIMARY PRES-SURE LOSS bar | SECONDARY FLOW m³/h | SECONDARY PRES-SURE LOSS bar | PRICE |
|-----------|----------|-------------------------|-------------------|----------------------------|---------------------|------------------------------|-----------|
| 203.11.83 | D-NWT 18 | 30 | 2.0 | 0.12 | 10 | 0.18 | 1,654.75€ |
| 203.11.84 | D-NWT 35 | 60 | 2.8 | 0.34 | 12 | 0.25 | 2,760.34€ |

D-SHWT 9/35 & 18/35 Combo Solar/Hybrid

Combo heating & solar - hybrid 18/42 - 30/42 kW stainless steel



Water/water heat exchanger, processed with the usual premium workmanship and care, can be broadly used as a hybrid heat exchanger. This way alternative energy is used and fossil fuels are added only when necessary. Like all coiled tubing heat exchangers, they must be integrated in the bathing water circuit either directly or through the bypass-system.

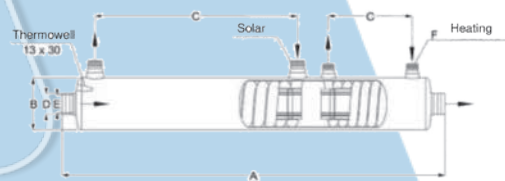
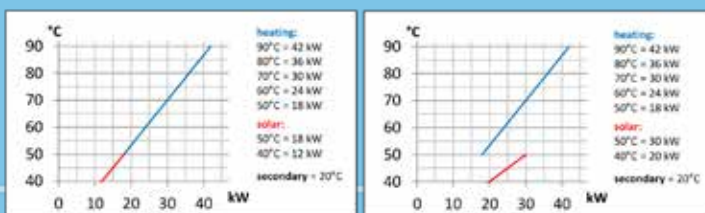

| MODEL | A | B | C | D | E | F |
|--------------|-------|-------|---------------|------|------------|------------------|
| D-SHWT 9/35 | 605mm | 125mm | 197mm X 197mm | 50mm | 1 1/2" fem | 3/4" X 3/4" male |
| D-SHWT 18/35 | 935mm | 125mm | 205mm X 495mm | 50mm | 1 1/2" fem | 1" X 3/4" male |

| CODE | MODEL | HEAT CAPACITY kW | PRIMARY MIN. PUMP CAPACITY | PRIMARY PRESSURE LOSS bar | SECONDARY MIN. PUMP CAPACITY | SECONDARY PRESSURE LOSS bar | PRICE |
|-----------|--------------|---------------------------------------|----------------------------|---------------------------|------------------------------|-----------------------------|------------|
| 203.11.85 | D-SHWT 9/35 | Solar 18 at 50°C Boiler 42 at 90°C | 2 & 2 m³/h | 0.18 | 10 m³/h | 0.12 | 1,734.89€ |
| 203.11.86 | D-SHWT 18/35 | Solar 30 at 50°C Boiler 42 at 90°C | 2 & 2 m³/h | 0.22 | 10 m³/h | 0.20 | 2,686,55 € |

D-TWT Series Full Titanium / High Temperature

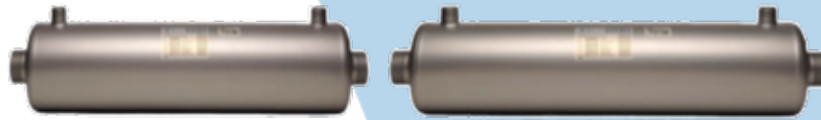

Water/water heat exchanger, processed with the usual premium workmanship and care, state of the art welding. This premium heat exchanger has uncompromised resistance to corrosion, even at high salt levels in the pool water, and is therefore seawater proof. These heat exchangers offer maximum energy efficiency at minimal pressure loss. Like all coiled tubing heat exchangers, they must be integrated in the bathing water circuit either directly or through the bypass-system.

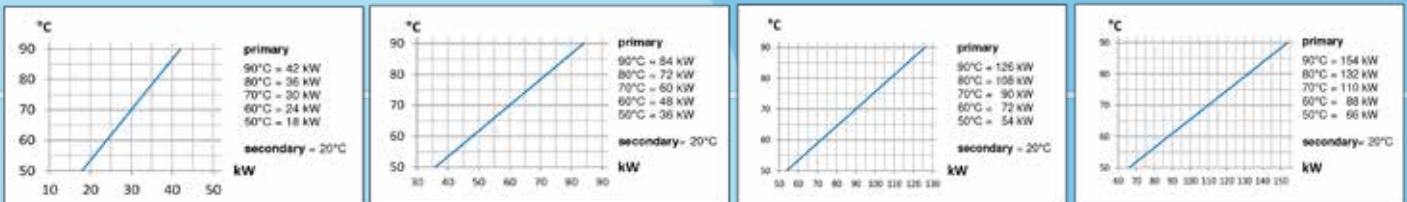

| MODEL | A | B | C | D | E |
|--------------|--------|-------|-------|------------|-----------|
| D-TWT Ti 35 | 385mm | 125mm | 205mm | 1 1/2" fem | 3/4" male |
| D-TWT Ti 65 | 680mm | 125mm | 495mm | 1 1/2" fem | 1" male |
| D-TWT Ti 93 | 780mm | 160mm | 590mm | 2" fem | 1" male |
| D-TWT Ti 115 | 1050mm | 160mm | 820mm | 2" fem | 1" male |

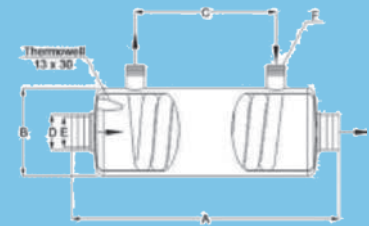

| CODE | MODEL | HEAT CAPACITY kW (90°C) | PRIMARY FLOW m³/h | PRIMARY PRES-SURE LOSS bar | SECONDARY FLOW m³/h | SECONDARY PRES-SURE LOSS bar | PRICE |
|-----------|--------------|-------------------------|-------------------|----------------------------|---------------------|------------------------------|-----------|
| 203.11.87 | D-TWT Ti 35 | 42 | 2.2 | 0.19 | 10 | 0.10 | 2,133.84€ |
| 203.11.88 | D-TWT Ti 65 | 84 | 3.0 | 0.23 | 15 | 0.25 | 2,907.78€ |
| 203.11.89 | D-TWT Ti 93 | 126 | 4.0 | 0.44 | 15 | 0.22 | 4,750.47€ |
| 203.11.90 | D-TWT Ti 115 | 154 | 3.8 | 0.56 | 15 | 0.25 | 6,077.22€ |

D-NWT-Ti 45 Full Titanium / Low Temperature

type D-NWT-Ti 45



Water/water heat exchanger, processed with the usual premium workmanship and care, state of the art welding. This premium heat exchanger has uncompromised resistance to corrosion, even at high salt levels in the pool water, and is therefore seawater proof. These heat exchangers offer maximum energy efficiency at minimal pressure loss. Like all coiled tubing heat exchangers, they must be integrated in the bathing water circuit either directly or through the bypass-system.

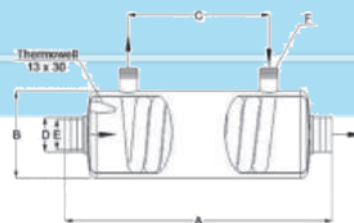
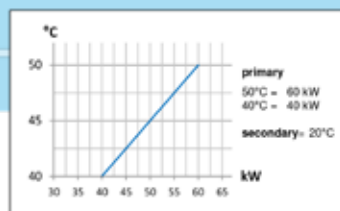

| MODEL | A | B | C | D | E |
|-------------|--------|-------|-------|--------|---------|
| D-NWT-Ti 45 | 1050mm | 160mm | 820mm | 2" fem | 1" male |

| CODE | MODEL | HEAT CAPACITY kW (50°C) | PRIMARY FLOW m³/h | PRIMARY PRES-SURE LOSS bar | SECONDARY FLOW m³/h | SECONDARY PRES-SURE LOSS bar | PRICE |
|-----------|-------------|-------------------------|-------------------|----------------------------|---------------------|------------------------------|-----------|
| 203.11.91 | D-NWT-Ti 45 | 60 | 2.8 | 0.34 | 15 | 0.25 | 6,961.72€ |

D-KWT Series - Plastic Cell



Water/water heat exchanger with coiled tubing in cross flow - unlike the smooth coiled tubing, the stainless steel, or respectively, the titanium-corrugated coiled tubing, offers high energy efficiency at low cost for material. The plastic shell can endure high pressure and is corrosion resistant. The individual components are sealed with silicon gaskets and ensure longevity of the whole heat exchanger. The cost-effectiveness and quality makes the titanium version especially attractive. Like all coiled tubing heat exchangers, they must be integrated in the bathing water circuit either directly or through the bypass-system.

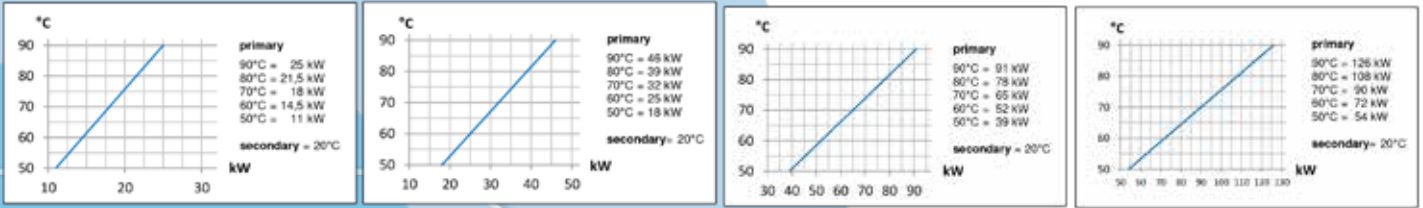

| MODEL | A | B | C | D | E | E |
|----------------|--------|-------|-------|-----|------|------|
| D-KWT 25 AISI | 345mm | 110mm | 135mm | Ø63 | 50mm | 3/4" |
| D-KWT 45 AISI | 415mm | 110mm | 135mm | Ø63 | 50mm | 3/4" |
| D-KWT 25 Ti | 345mm | 110mm | 135mm | Ø63 | 50mm | 3/4" |
| D-KWT 45 Ti | 415mm | 110mm | 135mm | Ø63 | 50mm | 3/4" |
| D-KWT 85 AISI | 705mm | 110mm | 495mm | Ø63 | 50mm | 1" |
| D-KWT 105 AISI | 1015mm | 110mm | 805mm | Ø63 | 50mm | 1" |
| D-KWT 85 Ti | 705mm | 110mm | 495mm | Ø63 | 50mm | 1" |
| D-KWT 105 Ti | 1015mm | 110mm | 805mm | Ø63 | 50mm | 1" |

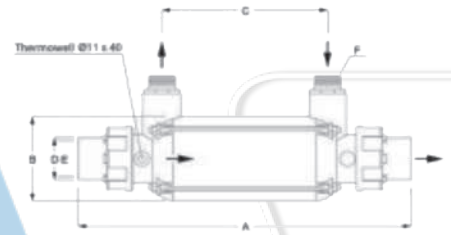

| CODE | MODEL | HEAT CAPACITY kW (90°C) | PRIMARY FLOW m³/h | PRIMARY PRES-SURE LOSS bar | SECONDARY FLOW m³/h | SECONDARY PRES-SURE LOSS bar | PRICE |
|-----------|----------------|-------------------------|-------------------|----------------------------|---------------------|------------------------------|-----------|
| 203.11.92 | D-KWT 25 AISI | 25 | 2.0 | 0.10 | 8 | 0.11 | 622.84€ |
| 203.11.93 | D-KWT 45 AISI | 46 | 2.0 | 0.15 | 10 | 0.15 | 733.38€ |
| 203.11.94 | D-KWT 25 Ti | 25 | 2.0 | 0.10 | 8 | 0.11 | 1,101.93€ |
| 203.11.95 | D-KWT 45 Ti | 46 | 2.0 | 0.15 | 10 | 0.15 | 1,286.20€ |
| 203.11.96 | D-KWT 85 AISI | 91 | 2.0 | 0.28 | 12 | 0.22 | 1,138.80€ |
| 203.11.97 | D-KWT 105 AISI | 126 | 2.0 | 0.36 | 15 | 0.30 | 1,839.00€ |
| 203.11.98 | D-KWT 85 Ti | 91 | 2.0 | 0.28 | 12 | 0.22 | 2,060.13€ |
| 203.11.99 | D-KWT 105 Ti | 126 | 2.0 | 0.36 | 15 | 0.30 | 2,834.07€ |

D-KWT 45/85 Intelligent Automatic Heat Exchanger



type D-KWT 45/85

The Compact Heat Exchanger of the series D- KWT 45 and 85 AISI /Ti Compact is, thanks to the latest technology, a high performance heat exchanger. It is equipped with a corrugated tube, either in stainless steel or titanium, which helps it function more efficiently and effectively improving the performance of the whole plant. It is completely wired and equipped with a circulation pump (three step for the primary circuit), non- return valve, on-off button, LED – control lamp and digital electric temperature regulation (adjustable from 0 – 42°C, with display of the actual temperature, adjustable bathing water temperature, and temperature difference which is factory-set at 0,5° C). Included is also a pair of plastic clamps to mount the device to the wall or on the ground. It is extremely versatile – for heating swimming pools, whirlpools, fish tanks, and similar facilities. The compact heat exchanger is easily and simply connected to the water circuit with the handy gluing socket D50. You can expect product longevity if the safety and installation instructions are closely followed.

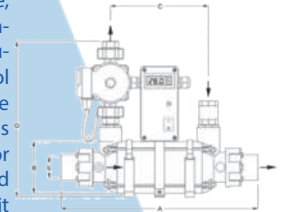

| MODEL | A | B | C | D | E |
|---------------|-------|-------|-------|-------|------|
| D-KWT 45 AISI | 415mm | 110mm | 205mm | 345mm | 50mm |
| D-KWT 85 AISI | 705mm | 110mm | 495mm | 345mm | 50mm |
| D-KWT 45 Ti | 415mm | 110mm | 205mm | 345mm | 50mm |
| D-KWT 85 Ti | 705mm | 110mm | 495mm | 345mm | 50mm |

| CODE | MODEL | HEAT CAPACITY kW (90°C) | PRIMARY FLOW m³/h | PRIMARY PRES-SURE LOSS bar | SECONDARY FLOW m³/h | SECONDARY PRES-SURE LOSS bar | PRICE |
|------------|---------------|-------------------------|-------------------|----------------------------|---------------------|------------------------------|-----------|
| 203.11.355 | D-KWT 45 AISI | 46 | 2.0 | 0.15 | 10 | 0.15 | 2,576.09€ |
| 203.11.356 | D-KWT 85 AISI | 84 | 1.8 | 0.25 | 12 | 0.22 | 3,018.35€ |
| 203.11.357 | D-KWT 45 Ti | 46 | 2.0 | 0.15 | 10 | 0.15 | 3,202.62€ |
| 203.11.358 | D-KWT 85 Ti | 84 | 1.8 | 0.25 | 12 | 0.22 | 3,792.28€ |

Heat Exchanger Controllers



Control set to use with water heat exchangers available in two versions, one with the primary connection of 3/4", the other with 1", wired, up to 85 kW. It consists of a circulation pump (three step for the primary circuit, energy category A), temperature sensor, non-return valve 3/4" and 1" internal thread, control with on-off button, LED- control lamp and digital electric temperature regulation (adjustable from 0-42 °C, with display of the actual temperature and temperature difference, which is factory set at 0,5 °C). The controller is also available without a pump or non-return valve. You can expect product longevity if the safety and installation instructions are closely followed.

| CODE | MODEL | PUMP CAPACITY | VOLTAGE | ELECTRIC TEMPERATURE | PRICE |
|------------|------------|---------------|---------|----------------------|-----------|
| 203.11.359 | Controller | Max 60W | 230V | 0 - 42 °C | 1,101.93€ |

Heat Exchanger Controllers with Pump



Control set to use with water heat exchangers available in two versions, one with the primary connection of 3/4", the other with 1", wired, up to 85 kW. It consists of a circulation pump (three step for the primary circuit, energy category A), temperature sensor, non-return valve 3/4" and 1" internal thread, control with on-off button, LED- control lamp and digital electric temperature regulation (adjustable from 0-42 °C, with display of the actual temperature and temperature difference, which is factory set at 0,5 °C). The controller is also available without a pump or non-return valve. You can expect product longevity if the safety and installation instructions are closely followed.

| CODE | MODEL | PUMP CAPACITY | MAX PUMP CAPACITY m³/h | VOLTAGE | ELECTRIC TEMPERATURE | PRICE |
|------------|----------|---------------|------------------------|---------|----------------------|-----------|
| 203.11.360 | Set 3/4" | 6 - 44 W | 3,3 | 230V | 0 - 42 °C | 1,470.48€ |
| 203.11.361 | Set 1" | 6 - 44 W | 3,3 | 230V | 0 - 42 °C | 1,544.18€ |

X-PWT AISI 40-300kW Plate Heat Exchanger AISI & Titanium

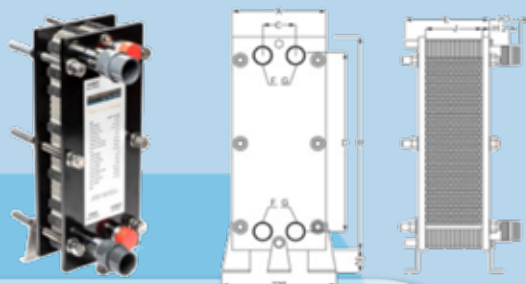

These plate heat exchangers have been made to heat bathing water with warm water. They are calculated at a temperature of 70 °C or 60 °C and have an operating range from 40 to 300 kW. Take advantage of the bolted plate heat exchangers, which feature high energy efficiency at low pressure loss, and are available in stainless steel AISI 316 or titanium.

| AISI | Titanium | A | B | C | D | E | H1/F | H2/G | J |
|----------------|--------------|-------|-------|------|-------|-------|----------------|-------------|---------|
| X-PWT 407 AISI | X-PWT 407 Ti | 200mm | 460mm | 69mm | 380mm | 110mm | 1 1/4" x 50x40 | 1 1/4" / 40 | 20,5mm |
| X-PWT 409 AISI | X-PWT 409 Ti | 200mm | 460mm | 69mm | 380mm | 110mm | 1 1/4" x 50x40 | 1 1/4" / 40 | 26,2mm |
| X-PWT 411 AISI | X-PWT 411 Ti | 200mm | 460mm | 69mm | 380mm | 110mm | 1 1/4" x 50x40 | 1 1/4" / 40 | 32,0mm |
| X-PWT 415 AISI | X-PWT 415 Ti | 200mm | 460mm | 69mm | 380mm | 170mm | 1 1/4" x 50x40 | 1 1/4" / 40 | 43,5mm |
| X-PWT 419 AISI | X-PWT 419 Ti | 200mm | 460mm | 69mm | 380mm | 170mm | 1 1/4" x 50x40 | 1 1/4" / 40 | 55,5mm |
| X-PWT 423 AISI | X-PWT 423 Ti | 200mm | 460mm | 69mm | 380mm | 110mm | 1 1/4" x 50x40 | 1 1/4" / 40 | 67,0mm |
| X-PWT 427 AISI | X-PWT 427 Ti | 200mm | 460mm | 69mm | 380mm | 110mm | 1 1/4" x 50x40 | 1 1/4" / 40 | 78,5mm |
| X-PWT 431 AISI | X-PWT 431 Ti | 200mm | 460mm | 69mm | 380mm | 110mm | 1 1/4" x 50x40 | 1 1/4" / 40 | 90,0mm |
| X-PWT 435 AISI | X-PWT 435 Ti | 200mm | 460mm | 69mm | 380mm | 170mm | 1 1/4" x 50x40 | 1 1/4" / 40 | 101,5mm |
| X-PWT 439 AISI | X-PWT 439 Ti | 200mm | 460mm | 69mm | 380mm | 170mm | 1 1/4" x 50x40 | 1 1/4" / 40 | 113,0mm |

| CODE | MODEL | HEAT CAPACITY kW (70°C) | PLATES | PRIMARY FLOW m³/h | PRIMARY PRESSURE LOSS bar | SECONDARY FLOW m³/h | SECONDARY PRESSURE LOSS bar | PRICE |
|------------|----------------|-------------------------|--------|-------------------|---------------------------|---------------------|-----------------------------|-----------|
| 203.11.100 | X-PWT 407 AISI | 40 | 7 | 1.4 | 0.25 | 1,4 | 0.24 | 1,654.75€ |
| 203.11.101 | X-PWT 409 AISI | 55 | 9 | 1.9 | 0.20 | 1,8 | 0.23 | 1,802.16€ |
| 203.11.102 | X-PWT 411 AISI | 75 | 11 | 2.5 | 0.25 | 2.4 | 0.25 | 1,912.71€ |
| 203.11.103 | X-PWT 415 AISI | 100 | 15 | 3.2 | 0.20 | 3.1 | 0.21 | 2,170.70€ |
| 203.11.104 | X-PWT 419 AISI | 135 | 19 | 4.2 | 0.21 | 4.3 | 0.24 | 2,465.53€ |
| 203.11.105 | X-PWT 423 AISI | 170 | 23 | 5.4 | 0.23 | 5.3 | 0.25 | 2,760.36€ |
| 203.11.106 | X-PWT 427 AISI | 195 | 27 | 6.2 | 0.22 | 6.0 | 0.23 | 3,128.90€ |
| 203.11.107 | X-PWT 431 AISI | 234 | 31 | 7.4 | 0.23 | 7.2 | 0.24 | 3,534.30€ |
| 203.11.108 | X-PWT 435 AISI | 260 | 35 | 8.0 | 0.22 | 8.0 | 0.24 | 3,865.99€ |
| 203.11.109 | X-PWT 439 AISI | 300 | 39 | 9.4 | 0.23 | 9.4 | 0.26 | 4,308.23€ |

| CODE | MODEL | HEAT CAPACITY kW (70°C) | PLATES | PRIMARY FLOW m³/h | PRIMARY PRESSURE LOSS bar | SECONDARY FLOW m³/h | SECONDARY PRESSURE LOSS bar | PRICE |
|------------|--------------|-------------------------|--------|-------------------|---------------------------|---------------------|-----------------------------|-----------|
| 203.11.110 | X-PWT 407 Ti | 40 | 7 | 1.4 | 0.25 | 1,4 | 0.24 | 2,207.55€ |
| 203.11.111 | X-PWT 409 Ti | 55 | 9 | 1.9 | 0.20 | 1,8 | 0.23 | 2,576.09€ |
| 203.11.112 | X-PWT 411 Ti | 75 | 11 | 2.5 | 0.25 | 2.4 | 0.25 | 2,944.64€ |
| 203.11.113 | X-PWT 415 Ti | 100 | 15 | 3.2 | 0.20 | 3.1 | 0.21 | 3,608.00€ |
| 203.11.114 | X-PWT 419 Ti | 135 | 19 | 4.2 | 0.21 | 4.3 | 0.24 | 4,308.23€ |
| 203.11.115 | X-PWT 423 Ti | 170 | 23 | 5.4 | 0.23 | 5.3 | 0.25 | 4,971.59€ |
| 203.11.116 | X-PWT 427 Ti | 195 | 27 | 6.2 | 0.22 | 6.0 | 0.23 | 5,708.68€ |
| 203.11.117 | X-PWT 431 Ti | 234 | 31 | 7.4 | 0.23 | 7.2 | 0.24 | 6,261.48€ |
| 203.11.118 | X-PWT 435 Ti | 260 | 35 | 8.0 | 0.22 | 8.0 | 0.24 | 6,998.57€ |
| 203.11.119 | X-PWT 439 Ti | 300 | 39 | 9.4 | 0.23 | 9.4 | 0.26 | 7,735.64€ |

13M-PWT AISI & Titanium 400-1200kW Plate Heat Exchanger, Solar & All Alternative Energy

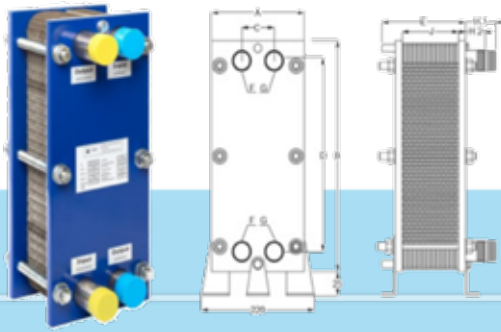

These plate heat exchangers have been made to heat bathing water with warm water. They are calculated at a temperature of 70 °C or 60 °C and have an operating range from 400 to 1200 kW. Take advantage of the bolted plate heat exchangers, which feature high energy efficiency at low pressure loss, and are available in stainless steel AISI 316.

| MODEL | A | B | C | D | E | H1/F | H2/G | J |
|---------|-------|-------|-------|-------|-------|---------------|---------------|-------|
| 14A/7B | 310mm | 725mm | 125mm | 600mm | 350mm | 58mm / 2 1/2" | 58mm / 2 1/2" | 71mm |
| 17A/10B | 310mm | 725mm | 125mm | 600mm | 350mm | 58mm / 2 1/2" | 58mm / 2 1/2" | 91mm |
| 25A/8B | 310mm | 725mm | 125mm | 600mm | 350mm | 58mm / 2 1/2" | 58mm / 2 1/2" | 112mm |
| 27A/10B | 310mm | 725mm | 125mm | 600mm | 350mm | 58mm / 2 1/2" | 58mm / 2 1/2" | 125mm |
| 26A/17B | 310mm | 725mm | 125mm | 600mm | 450mm | 58mm / 2 1/2" | 58mm / 2 1/2" | 146mm |
| 31A/18B | 310mm | 725mm | 125mm | 600mm | 450mm | 58mm / 2 1/2" | 58mm / 2 1/2" | 166mm |
| 35A/18B | 310mm | 725mm | 125mm | 600mm | 450mm | 58mm / 2 1/2" | 58mm / 2 1/2" | 180mm |
| 35A/22B | 310mm | 725mm | 125mm | 600mm | 450mm | 58mm / 2 1/2" | 58mm / 2 1/2" | 193mm |
| 46A/15B | 310mm | 725mm | 125mm | 600mm | 450mm | 58mm / 2 1/2" | 58mm / 2 1/2" | 207mm |

| CODE | MODEL 13M-PWT AISI | HEAT CAPACITY kW (70°C) | PLATES | PRIMARY FLOW m³/h | PRIMARY PRESSURE LOSS bar | SECONDARY FLOW m³/h | SECONDARY PRESSURE LOSS bar | PRICE |
|------------|--------------------------|-------------------------------|--------|-------------------------|------------------------------------|---------------------------|-----------------------------------|------------|
| 203.11.120 | 14A/7B | 400 | 21 | 12 | 0.27 | 12,5 | 0.31 | 4,787.33€ |
| 203.11.121 | 17A/10B | 500 | 27 | 15 | 0.24 | 16 | 0.29 | 7,661.93€ |
| 203.11.122 | 25A/8B | 600 | 33 | 16 | 0.20 | 20 | 0.34 | 8,620.15€ |
| 203.11.123 | 27A/10B | 700 | 37 | 18 | 0.20 | 25 | 0.40 | 9,246.66€ |
| 203.11.124 | 26A/17B | 800 | 43 | 22 | 0.19 | 28 | 0.33 | 10,204.86€ |
| 203.11.125 | 31A/18B | 900 | 49 | 24 | 0.18 | 32 | 0.34 | 11,126.21€ |
| 203.11.126 | 35A/18B | 1000 | 53 | 26 | 0.19 | 38 | 0.42 | 11,752.73€ |
| 203.11.127 | 35A/22B | 1100 | 57 | 28 | 0.18 | 44 | 0.46 | 12,379.24€ |
| 203.11.128 | 46A/15B | 1200 | 61 | 30 | 0.20 | 44 | 0.46 | 13,042.61€ |

| CODE | MODEL 13M-PWT TITANIUM | HEAT CAPACITY kW (70°C) | PLATES | PRIMARY FLOW m³/h | PRIMARY PRESSURE LOSS bar | SECONDARY FLOW m³/h | SECONDARY PRESSURE LOSS bar | PRICE |
|------------|------------------------------|-------------------------------|--------|-------------------------|------------------------------------|---------------------------|-----------------------------------|------------|
| 203.11.129 | 14A/7B | 400 | 21 | 12 | 0.27 | 12,5 | 0.31 | 10,868.25€ |
| 203.11.130 | 17A/10B | 500 | 27 | 15 | 0.24 | 16 | 0.29 | 13,079.48€ |
| 203.11.131 | 25A/8B | 600 | 33 | 16 | 0.20 | 20 | 0.34 | 15,290.71€ |
| 203.11.132 | 27A/10B | 700 | 37 | 18 | 0.20 | 25 | 0.40 | 16,764.87€ |
| 203.11.133 | 26A/17B | 800 | 43 | 22 | 0.19 | 28 | 0.33 | 18,976.11€ |
| 203.11.134 | 31A/18B | 900 | 49 | 24 | 0.18 | 32 | 0.34 | 21,187.35€ |
| 203.11.135 | 35A/18B | 1000 | 53 | 26 | 0.19 | 38 | 0.42 | 22,661.51€ |
| 203.11.136 | 35A/22B | 1100 | 57 | 28 | 0.18 | 44 | 0.46 | 24,135.67€ |
| 203.11.137 | 46A/15B | 1200 | 61 | 30 | 0.20 | 44 | 0.46 | 25,609.82€ |

G-PWT AISI & Titanium 32-120kW Plate Heat Exchanger Solar & all Alternative Energy - Low Temp

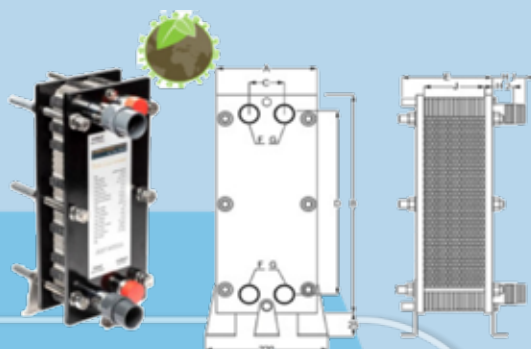

These plate heat exchangers have been made to heat bathing water with warm water. Thanks to the large exchange surface they are excellently suitable for using low temperature heating systems, for example, solar heating systems, geothermal plants, heat pumps and similar alternative and innovative heating systems.

| MODEL | A | B | C | D | E | H1/F | H2/G | J |
|--------------|-------|-------|------|-------|-------|--------------|-------------|--------|
| G-PWT 30 Ai | 200mm | 460mm | 69mm | 380mm | 110mm | 1 1/4"x50x40 | 1 1/4" / 40 | 26,3mm |
| G-PWT 50 Ai | 200mm | 460mm | 69mm | 380mm | 110mm | 1 1/4"x50x40 | 1 1/4" / 40 | 38,0mm |
| G-PWT 70 Ai | 200mm | 460mm | 69mm | 380mm | 110mm | 1 1/4"x50x40 | 1 1/4" / 40 | 49,6mm |
| G-PWT 100 Ai | 200mm | 460mm | 69mm | 380mm | 170mm | 1 1/4"x50x40 | 1 1/4" / 40 | 61,2mm |
| G-PWT 120 Ai | 200mm | 460mm | 69mm | 380mm | 170mm | 1 1/4"x50x40 | 1 1/4" / 40 | 72,7mm |

| CODE | MODEL G-PWT AISI | HEAT CAPACITY kW (55°C) | PLATES | PRIMARY FLOW m ³ /h | PRIMARY PRESSURE LOSS bar | SECONDARY FLOW m ³ /h | SECONDARY PRESSURE LOSS bar | PRICE |
|------------|------------------------|-------------------------------|--------|--------------------------------------|------------------------------------|--|-----------------------------------|-----------|
| 203.11.138 | G-PWT 30 Ai | 32 | 9 | 1,6 | 0.17 | 1,6 | 0.18 | 1,839.00€ |
| 203.11.139 | G-PWT 50 Ai | 55 | 13 | 2,6 | 0.20 | 2,7 | 0.23 | 1,097.00€ |
| 203.11.140 | G-PWT 70 Ai | 75 | 17 | 3,2 | 0.14 | 4,0 | 0.28 | 2,354.96€ |
| 203.11.141 | G-PWT 100 Ai | 100 | 21 | 4,5 | 0.21 | 4,6 | 0.23 | 2,576.09€ |
| 203.11.142 | G-PWT 120 Ai | 120 | 25 | 5,0 | 0.19 | 6,0 | 0.28 | 2,834.07€ |

| CODE | MODEL G-PWT TITANIUM | HEAT CAPACITY kW (55°C) | PLATES | PRIMARY FLOW m ³ /h | PRIMARY PRESSURE LOSS bar | SECONDARY FLOW m ³ /h | SECONDARY PRESSURE LOSS bar | PRICE |
|------------|----------------------------|-------------------------------|--------|--------------------------------------|------------------------------------|--|-----------------------------------|-----------|
| 203.11.143 | G-PWT 30 Ti | 32 | 9 | 1,6 | 0.17 | 1,6 | 0.18 | 2,760.36€ |
| 203.11.144 | G-PWT 50 Ti | 55 | 13 | 2,6 | 0.20 | 2,7 | 0.23 | 3,497.44€ |
| 203.11.145 | G-PWT 70 Ti | 75 | 17 | 3,2 | 0.14 | 4,0 | 0.28 | 4,234.51€ |
| 203.11.146 | G-PWT 100 Ti | 100 | 21 | 4,5 | 0.21 | 4,6 | 0.23 | 4,971.59€ |
| 203.11.147 | G-PWT 120 Ti | 120 | 25 | 5,0 | 0.19 | 6,0 | 0.28 | 5,708.68€ |

D-PWT AISI

Solar & all Alternative Energy - Low Temp

These plate heat exchangers have been made to heat bathing water with warm water. Thanks to the large exchange surface they are excellently suitable for using low temperature heating systems, for example, solar heating systems, geothermal plants, heat pumps and similar alternative and innovative heating systems.



| MODEL | A | B | C | D | E | F | G | H |
|---------|-------|-------|------|-------|-------|-------------|-------------|------|
| D-PWT30 | 106mm | 306mm | 50mm | 250mm | 45mm | 3/4" female | 1" male | 28mm |
| D-PWT50 | 124mm | 304mm | 70mm | 250mm | 60mm | 1" female | 1 1/4" male | 28mm |
| D-PWT75 | 124mm | 304mm | 70mm | 250mm | 102mm | 1" female | 1 1/4" male | 28mm |

| CODE | MODEL | HEAT CAPACITY kW (70°C) | PLATES | PRIMARY FLOW m³/h | PRIMARY PRESSURE LOSS bar | SECONDARY FLOW m³/h | SECONDARY PRESSURE LOSS bar | PRICE | |
|------------|------------|-------------------------|--------|-------------------|---------------------------|---------------------|-----------------------------|-----------|---------|
| 203.11.148 | D-PWT30 | 30 | 14 | 1,5 | 0.29 | 1,8 | 0.30 | 843.97€ | |
| 203.11.149 | D-PWT50 | 50 | 20 | 2,1 | 0.22 | 2,2 | 0.25 | 954.51€ | |
| 203.11.150 | D-PWT75 | 75 | 38 | 2,8 | 0.13 | 3,0 | 0.16 | 1,470.48€ | |
| 203.11.151 | Insulation | | | | | | | | 549.13€ |

DW-PWT EN1717 Conform Double Wall

In situations where regulations or other reasons call for special safety, a double wall heat exchanger must be used. The individual plates consist of two extremely thin plates which form a narrow and protective leakage gap. In case of failure e.g., rupture of a plate or corrosion, it is guaranteed that the water of the affected circuit will be visibly pushed out, so there won't be a problem with two liquids mixing. It is often the case that toxic antifreeze, like glycol or similar harmful substance, gets into the primary heating circuit but should never get in contact with people or the environment. Double wall safety heat exchangers protect people and the environment. For a long durability please pay attention to the technical safety features and the assembly instructions.

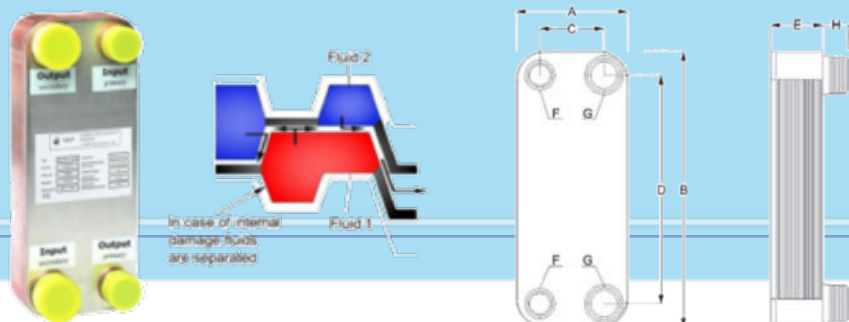

| MODEL | A | B | C | D | E | F | G | H |
|--------|-------|-------|------|-------|------|-------|-----------|------|
| DW-PWT | 125mm | 335mm | 73mm | 281mm | 60mm | 1" AG | 1 1/4" AG | 20mm |

| CODE | FLUID | HEAT CAPACITY | PRIMARY FLOW m³/h | PRIMARY PRESSURE LOSS bar | SECONDARY FLOW m³/h | SECONDARY PRESSURE LOSS bar | PRICE |
|------------|----------|---------------|-------------------|---------------------------|---------------------|-----------------------------|-----------|
| 203.11.152 | Solar | 30kW / 25°C | 2,2 | 0.19 | 2,5 | 0.21 | 2,170.70€ |
| | Standard | 100kW / 44°C | 1,0 | 0.04 | 2,5 | 0.21 | |

Performance Chart for a Heat-Up time of 5 hours

This datasheet shows the necessary heat exchanger capacity for a specific pool size to reach a temperature increase in 5 hours. This way you can choose the right heat exchanger based on the daily temperature loss.

| Temperature Increase In 5 hours | Pool 20 m ³ | Pool 40 m ³ | Pool 60 m ³ | Pool 100 m ³ | Pool 120 m ³ | Pool 150 m ³ |
|---------------------------------|------------------------|------------------------|------------------------|-------------------------|-------------------------|-------------------------|
| 0,5 °C | 3 kW | 5 kW | 8 kW | 13 kW | 15 kW | 19 kW |
| 1 °C | 5 kW | 10 kW | 15 kW | 26 kW | 31 kW | 39 kW |
| 1,5 °C | 8 kW | 15 kW | 23 kW | 39 kW | 46 kW | 58 kW |
| 2 °C | 10 kW | 21 kW | 31 kW | 51 kW | 62 kW | 77 kW |
| 2,5 °C | 13 kW | 26 kW | 39 kW | 64 kW | 77 kW | 96 kW |
| 3 °C | 15 kW | 31 kW | 46 kW | 77 kW | 92 kW | 115 kW |
| 3,5 °C | 18 kW | 36 kW | 54 kW | 90 kW | 108 kW | 135 kW |
| 4 °C | 21 kW | 41 kW | 62 kW | 103 kW | 123 kW | 155 kW |
| 5 °C | 26 kW | 51 kW | 77 kW | 128 kW | 154 kW | 192 kW |

Capacity loss for water/water COILED tubing Heat Exchangers with increasing bathing water temperature

| Type | Capacity with pool water at 20 °C | | | Capacity loss with pool water at 24 °C | Capacity loss with pool water at 28 °C | Capacity loss with pool water at 30 °C |
|--------------------|-----------------------------------|--------|--------|--|--|--|
| | 90 °C | 70 °C | 50 °C | | | |
| D-HWT 12 | 14 kW | 10 kW | 6 kW | -0,8 kW | -1,6 kW | -2 kW |
| D-KWT 25 | 25 kW | 18 kW | 11 kW | -1,44 kW | -2,88 kW | -3,6 kW |
| D-HWT 24 | 28 kW | 20 kW | 12 kW | -1,6 kW | -3,2 kW | -4 kW |
| D-HWT 35 / TWT 35 | 42 kW | 30 kW | 18 kW | -2,4 kW | -4,8 kW | -6,0 kW |
| D-KWT 45 | 46 kW | 32 kW | 18 kW | -2,64 kW | -5,28 kW | -6,6 kW |
| D-HWT 54 | 63 kW | 45 kW | 27 kW | -3,6 kW | -7,2 kW | -9 kW |
| D-NWT 18 | -- | -- kW | 30 kW | -4 kW | -8 kW | -10 kW |
| D-HWT 65 / TWT 65 | 84 kW | 60 kW | 36 kW | -4,8 kW | -9,6 kW | -12 kW |
| D-KWT 85 | 91 kW | 65 kW | 39 kW | -5,2 kW | -10,4 kW | -13 kW |
| D-TWT 93 / KWT 105 | 126 kW | 90 kW | 54 kW | -7,2 kW | -14,4 kW | -18 kW |
| D-HWT 93 | 133 kW | 95 kW | 57 kW | -7,6 kW | -15,2 kW | -19 kW |
| D-NWT 35 / Ti 45 | -- | -- | 60 kW | -8 kW | -16 kW | -20 kW |
| D-TWT 115 | 154 kW | 110 kW | 66 kW | -8,8 kW | -17,6 kW | -22 kW |
| D-HWTV122 | 175 kW | 125 kW | 75 kW | -10 kW | -20 kW | -25 kW |
| D-HWT 182 | 259 kW | 185 kW | 111 kW | -14,8 kW | -29,6 kW | -37kW |

Capacity loss for water/water PLATE tubing Heat Exchangers with increasing bathing water temperature

| Type | Capacity with pool water at 20 °C | | | Capacity loss with pool water at 24 °C | Capacity loss with pool water at 28 °C | Capacity loss with pool water at 30 °C |
|-----------|-----------------------------------|--------|--------|--|--|--|
| | 70 °C | 60 °C | 55 °C | | | |
| X-PWT 407 | 40 kW | 33 kW | -- | -2,8 kW | -5,6 kW | -7 kW |
| X-PWT 409 | 55 kW | 45 kW | -- | -4 kW | -8 kW | -10 kW |
| X-PWT 411 | 75 kW | 60 kW | -- | -6 kW | -12 kW | -15 kW |
| X-PWT 415 | 100 kW | 78 kW | -- | -8,8 kW | -17,6 kW | -22 kW |
| X-PWT 419 | 135 kW | 105 kW | -- | -12 kW | -24 kW | -30 kW |
| X-PWT 423 | 170 kW | 133 kW | -- | -14,8 kW | -29,6 kW | -37 kW |
| X-PWT 427 | 195 kW | 153 kW | -- | -16,8 kW | -33,6 kW | -42 kW |
| X-PWT 431 | 234 kW | 183 kW | -- | -20,4 kW | -40,8 kW | -51 kW |
| X-PWT 435 | 260 kW | 202 kW | -- | -23,2 kW | -46,4 kW | -58 kW |
| X-PWT 439 | 300 kW | 235 kW | -- | -26 kW | -52 kW | -65 kW |
| G-PWT 30 | -- | -- | 32 kW | -3,6 kW | -7,2 kW | -9 kW |
| G-PWT 50 | -- | -- | 55 kW | -6 kW | -12 kW | -15 kW |
| G-PWT 70 | -- | -- | 75 kW | -8,4 kW | -16,8 kW | -21 kW |
| G-PWT 100 | -- | -- | 100 kW | -12 kW | -24 kW | -30 kW |
| G-PWT 120 | -- | -- | 120 kW | -14,4 kW | -28,8 kW | -36kW |
| D-PWT 30 | -- | -- | 30 kW | -2,8 kW | -4,9 kW | -7 kW |
| D-PWT 50 | -- | -- | 50 kW | -5,6 kW | -9,8 kW | -14 kW |
| D-PWT 75 | -- | -- | 75 kW | -8 kW | -14 kW | -20 kW |

Prestige Line

We designed the enclosure to match today's needs and especially the trends of modern architecture. The system is equipped with a single rail on one side which allows barrier-free access to the pool from 3 sides with minimal effort thanks to the substantial and stable construction. The discrete PRESTIGEline enclosure won't disrupt the layout of your garden and will harmoniously blend with the surroundings.

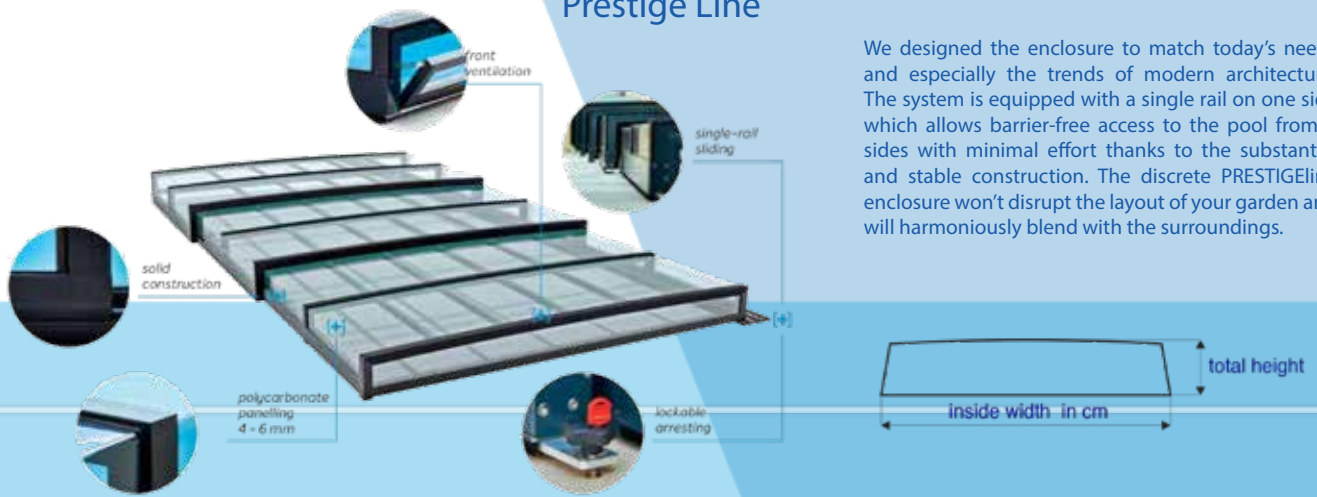

CONSTRUCTION & COLOUR OPTIONS



| Number of segments | 3 segments | | | 4 segments | | |
|--------------------------------------|--------------------|-------------|-------------|--------------------|-------------|-------------|
| Length | from 550 to 750 cm | | | from 751 to 850 cm | | |
| Width of the track | 27,7 cm | | | 37,2 cm | | |
| Inside width (cm) | Total height (m) | PC 4mm | PC 6mm | Total height (m) | PC 4mm | PC 6mm |
| 300 cm | 0,46 | 23.003,46 € | 28.959,44 € | 0,56 | 28.458,04 € | 35.863,51 € |
| 325 cm | 0,47 | 23.550,43 € | 29.354,48 € | 0,56 | 29.023,25 € | 36.173,47 € |
| 350 cm | 0,47 | 23.945,47 € | 29.962,23 € | 0,57 | 29.588,46 € | 36.541,16 € |
| 375 cm | 0,48 | 24.492,45 € | 30.600,37 € | 0,57 | 30.013,89 € | 36.881,50 € |
| 400 cm | 0,48 | 25.039,43 € | 30.904,25 € | 0,58 | 30.974,14 € | 37.416,32 € |
| 425 cm | 0,49 | 25.373,69 € | 31.268,90 € | 0,58 | 31.934,39 € | 38.236,79 € |
| 450 cm | 0,49 | 25.586,41 € | 31.724,71 € | 0,59 | 33.490,24 € | 39.282,12 € |
| 475 cm | 0,50 | 26.649,97 € | 32.423,63 € | 0,59 | 33.997,71 € | 39.707,55 € |
| 500 cm | 0,50 | 28.442,85 € | 33.274,48 € | 0,60 | 34.477,83 € | 40.272,76 € |
| 525 cm | 0,51 | 30.083,78 € | 34.489,99 € | 0,60 | 35.325,65 € | 41.035,49 € |
| Extension of the running track / 1 m | 139,78 € | | | 176,25 € | | |

| Number of segments | 4 segments | | | 5 segments | | |
|--------------------------------------|---------------------|-------------|-------------|----------------------|-------------|-------------|
| Length | from 851 to 1000 cm | | | from 1001 to 1150 cm | | |
| Width of the track | 37,2 cm | | | 46,7 cm | | |
| Inside width (cm) | Total height (m) | PC 4mm | PC 6mm | Total height (m) | PC 4mm | PC 6mm |
| 300 cm | 0,56 | 30.600,37 € | 38.561,94 € | 0,65 | 38.622,71 € | 45.885,36 € |
| 325 cm | 0,56 | 31.208,12 € | 38.896,20 € | 0,66 | 38.865,81 € | 46.705,83 € |
| 350 cm | 0,57 | 31.815,88 € | 39.291,24 € | 0,66 | 39.352,01 € | 47.556,68 € |
| 375 cm | 0,57 | 32.271,69 € | 39.655,89 € | 0,67 | 39.807,83 € | 48.377,15 € |
| 400 cm | 0,58 | 33.304,87 € | 40.233,26 € | 0,67 | 40.263,64 € | 49.440,72 € |
| 425 cm | 0,58 | 34.338,05 € | 41.114,50 € | 0,68 | 42.390,78 € | 50.747,39 € |
| 450 cm | 0,59 | 36.009,37 € | 42.238,84 € | 0,68 | 44.578,69 € | 52.236,38 € |
| 475 cm | 0,59 | 36.556,35 € | 42.694,66 € | 0,69 | 45.186,44 € | 52.874,52 € |
| 500 cm | 0,60 | 37.072,94 € | 43.302,41 € | 0,69 | 45.885,36 € | 53.573,44 € |
| 525 cm | 0,60 | 37.984,57 € | 44.122,88 € | 0,70 | 46.766,60 € | 54.485,07 € |
| Extension of the running track / 1 m | 139,78 € | | | 176,25 € | | |

Comfort Line - Linear Model Pool Cover



The COMFORTline series offers a wide range of classic models from which you can choose according to your needs. The anodised aluminium profiles are extra solid and durable. That is why we guarantee a 10-year warranty. The anodised surface finish of the profiles provides long operation life, stability and resistance to environmental impact (natural effects, chemicals, or salt in the pool).



| Number of segments | 3 segments | | 4 segments | | 4 segments | | 5 segments | |
|--------------------------------------|--------------------|-------------|--------------------|-------------|---------------------|-------------|----------------------|-------------|
| Length | from 550 to 750 cm | | from 751 to 850 cm | | from 851 to 1000 cm | | from 1001 to 1150 cm | |
| Width of the track | 21,6 cm | | 28,6 cm | | 28,6 cm | | 35,6 cm | |
| Inside width (cm) | Total height (m) | PC 4mm | Total height (m) | PC 4mm | Total height (m) | PC 4mm | Total height (m) | PC 4mm |
| 300 cm | 0,55 | 17.442,51 € | 0,60 | 21.149,81 € | 0,60 | 22.729,97 € | 0,65 | 29.384,86 € |
| 325 cm | 0,60 | 17.685,62 € | 0,65 | 21.484,07 € | 0,65 | 23.125,01 € | 0,66 | 29.810,29 € |
| 350 cm | 0,60 | 18.202,21 € | 0,65 | 22.031,05 € | 0,65 | 23.702,37 € | 0,66 | 30.266,11 € |
| 375 cm | 0,65 | 18.961,90 € | 0,70 | 22.578,03 € | 0,70 | 24.249,35 € | 0,67 | 31.147,35 € |
| 400 cm | 0,65 | 19.782,36 € | 0,70 | 23.398,50 € | 0,70 | 25.160,98 € | 0,67 | 32.423,63 € |
| 425 cm | 0,65 | 20.298,95 € | 0,70 | 24.340,51 € | 0,70 | 26.163,77 € | 0,68 | 33.183,32 € |
| 450 cm | 0,70 | 20.937,10 € | 0,75 | 24.765,94 € | 0,75 | 26.619,59 € | 0,68 | 33.821,46 € |
| 475 cm | 0,75 | 21.636,01 € | 0,80 | 26.376,49 € | 0,80 | 28.351,68 € | 0,69 | 35.249,68 € |
| 500 cm | 0,75 | 23.033,84 € | 0,80 | 28.047,81 € | 0,80 | 30.174,94 € | 0,69 | 37.559,14 € |
| Extension of the running track / 1 m | 127,63 € | | 158,02 € | | 158,02 € | | 188,40 € | |

Comfort Line - Symphony Model Pool Cover



The COMFORT line series offers a wide range of classic models from which you can choose according to your needs. The anodised aluminium profiles are extra solid and durable. That is why we guarantee a 10-year warranty. The anodised surface finish of the profiles provides long operation life, stability and resistance to environmental impact (natural effects, chemicals, or salt in the pool).

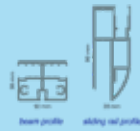
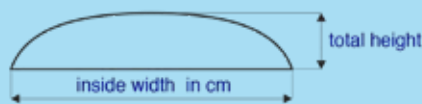

CONSTRUCTION & COLOUR OPTIONS



| Number of segments | 3 segments | | | 4 segments | | |
|--------------------------------------|--------------------|-------------|-------------|--------------------|-------------|-------------|
| Length | from 550 to 750 cm | | | from 751 to 850 cm | | |
| Width of the track | 21,6 cm | | | 28,6 cm | | |
| Inside width (cm) | Total height (m) | PC 10mm | PC 4mm | Total height (m) | PC 10mm | PC 4mm |
| 300 cm | 0,75 | 13.613,67 € | 16.591,66 € | 0,85 | 16.622,05 € | 20.147,02 € |
| 325 cm | 0,75 | 13.917,55 € | 16.834,76 € | 0,85 | 16.925,92 € | 20.481,28 € |
| 350 cm | 0,80 | 14.130,26 € | 17.320,96 € | 0,90 | 17.199,41 € | 20.997,87 € |
| 375 cm | 0,80 | 14.464,52 € | 18.050,27 € | 0,90 | 18.111,04 € | 21.484,07 € |
| 400 cm | 0,85 | 14.829,18 € | 18.840,35 € | 0,95 | 19.053,06 € | 22.274,15 € |
| 425 cm | 0,85 | 15.193,83 € | 19.326,55 € | 0,95 | 19.630,43 € | 23.185,78 € |
| 450 cm | 0,90 | 15.680,03 € | 19.934,30 € | 1,00 | 20.238,18 € | 23.580,82 € |
| 475 cm | 0,90 | 16.652,44 € | 20.602,83 € | 1,00 | 20.876,32 € | 25.100,20 € |
| 500 cm | 0,95 | 17.685,62 € | 21.939,89 € | 1,00 | 21.605,62 € | 26.710,75 € |
| 525 cm | 0,95 | 18.597,25 € | 23.337,72 € | 1,05 | 22.213,38 € | 28.047,81 € |
| Extension of the running track / 1 m | 127,63 € | | | 158,02 € | | |

| Number of segments | 4 segments | | | 5 segments | | |
|--------------------------------------|---------------------|-------------|-------------|----------------------|-------------|-------------|
| Length | from 851 to 1000 cm | | | from 1001 to 1150 cm | | |
| Width of the track | 28,6 cm | | | 35,6 cm | | |
| Inside width (cm) | Total height (m) | PC 10mm | PC 4mm | Total height (m) | PC 10mm | PC 4mm |
| 300 cm | 0,85 | 17.867,94 € | 21.636,01 € | 0,90 | 21.696,79 € | 27.987,03 € |
| 325 cm | 0,85 | 18.171,82 € | 22.000,66 € | 0,90 | 21.879,11 € | 28.382,07 € |
| 350 cm | 0,90 | 18.506,08 € | 22.578,03 € | 0,95 | 23.094,62 € | 28.807,50 € |
| 375 cm | 0,90 | 19.448,10 € | 23.094,62 € | 0,95 | 24.857,10 € | 29.658,35 € |
| 400 cm | 0,95 | 20.511,67 € | 23.945,47 € | 1,00 | 25.616,79 € | 30.873,86 € |
| 425 cm | 0,95 | 21.089,03 € | 24.917,88 € | 1,00 | 26.376,49 € | 31.603,16 € |
| 450 cm | 1,00 | 21.757,56 € | 25.343,31 € | 1,05 | 27.227,34 € | 32.210,92 € |
| 475 cm | 1,00 | 22.426,09 € | 26.984,24 € | 1,05 | 28.078,19 € | 33.547,97 € |
| 500 cm | 1,05 | 23.216,17 € | 28.716,34 € | 1,05 | 29.020,21 € | 35.766,27 € |
| 525 cm | 1,05 | 23.884,70 € | 30.144,56 € | 1,10 | 30.023,00 € | 37.316,04 € |
| Extension of the running track / 1 m | 158,02 € | | | 188,40 € | | |

Comfort Line - Symphony Plus Model Pool Cover



The COMFORTline series offers a wide range of classic models from which you can choose according to your needs. The anodised aluminium profiles are extra solid and durable. That is why we guarantee a 10-year warranty. The anodised surface finish of the profiles provides long operation life, stability and resistance to environmental impact (natural effects, chemicals, or salt in the pool).

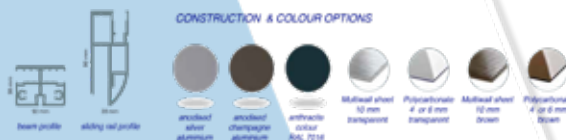
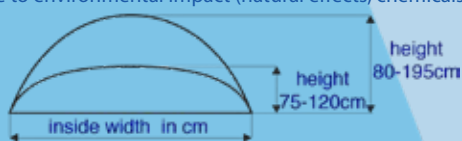

| Number of segments | 3 segments | | | 4 segments | | |
|--------------------------------------|--------------------|-------------|-------------|--------------------|-------------|-------------|
| Length | from 550 to 750 cm | | | from 751 to 850 cm | | |
| Width of the track | 21,6 cm | | | 28,6 cm | | |
| Inside width (cm) | Total height (m) | PC 10mm | PC 4mm | Total height (m) | PC 10mm | PC 4mm |
| 300 cm | 0,75 | 14.160,65 € | 17.260,19 € | 0,85 | 17.290,58 € | 20.937,10 € |
| 325 cm | 0,75 | 14.494,91 € | 17.533,68 € | 0,85 | 17.594,45 € | 21.301,75 € |
| 350 cm | 0,80 | 14.707,63 € | 18.019,88 € | 0,90 | 17.898,33 € | 21.848,72 € |
| 375 cm | 0,80 | 15.072,28 € | 18.779,57 € | 0,90 | 18.840,35 € | 22.365,32 € |
| 400 cm | 0,85 | 15.436,93 € | 19.600,04 € | 0,95 | 19.812,75 € | 23.185,78 € |
| 425 cm | 0,85 | 15.801,58 € | 20.116,63 € | 0,95 | 20.420,51 € | 24.127,80 € |
| 450 cm | 0,90 | 16.318,17 € | 20.754,77 € | 1,00 | 21.058,65 € | 24.522,84 € |
| 475 cm | 0,90 | 17.320,96 € | 21.453,69 € | 1,00 | 21.696,79 € | 26.103,00 € |
| 500 cm | 0,95 | 18.384,53 € | 22.821,13 € | 1,00 | 22.456,48 € | 27.774,32 € |
| Extension of the running track / 1 m | | 127,63 € | | | 158,02 € | |

| Number of segments | 4 segments | | | 5 segments | | |
|--------------------------------------|---------------------|-------------|-------------|----------------------|-------------|-------------|
| Length | from 851 to 1000 cm | | | from 1001 to 1150 cm | | |
| Width of the track | 28,6 cm | | | 35,6 cm | | |
| Inside width (cm) | Total height (m) | PC 10mm | PC 4mm | Total height (m) | PC 10mm | PC 4mm |
| 300 cm | 0,85 | 18.597,25 € | 22.517,25 € | 0,90 | 22.578,03 € | 29.111,37 € |
| 325 cm | 0,85 | 18.901,12 € | 22.881,91 € | 0,90 | 22.760,35 € | 29.536,80 € |
| 350 cm | 0,90 | 19.235,39 € | 23.489,66 € | 0,95 | 24.036,64 € | 29.962,23 € |
| 375 cm | 0,90 | 20.238,18 € | 24.036,64 € | 0,95 | 25.859,90 € | 30.873,86 € |
| 400 cm | 0,95 | 21.332,13 € | 24.917,88 € | 1,00 | 26.619,59 € | 32.119,75 € |
| 425 cm | 0,95 | 21.939,89 € | 25.920,67 € | 1,00 | 27.440,05 € | 32.879,44 € |
| 450 cm | 1,00 | 22.638,80 € | 26.376,49 € | 1,05 | 28.321,30 € | 33.517,58 € |
| 475 cm | 1,00 | 23.337,72 € | 28.078,19 € | 1,05 | 29.202,54 € | 34.915,42 € |
| 500 cm | 1,05 | 24.158,19 € | 29.871,07 € | 1,05 | 30.174,94 € | 37.194,49 € |
| Extension of the running track / 1 m | | 158,02 € | | | 188,40 € | |

Comfort Line - Practic Model Pool Cover



The COMFORTline series offers a wide range of classic models from which you can choose according to your needs. The anodised aluminium profiles are extra solid and durable. That is why we guarantee a 10-year warranty. The anodised surface finish of the profiles provides long operation life, stability and resistance to environmental impact (natural effects, chemicals, or salt in the pool).

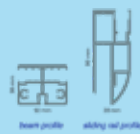
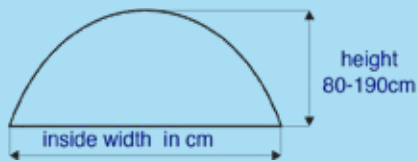

CONSTRUCTION & COLOUR OPTIONS

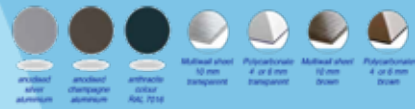

| Number of segments | 3 segments | | | 4 segments | | |
|--------------------------------------|--------------------|-------------|-------------|--------------------|-------------|-------------|
| Length | from 550 to 750 cm | | | from 751 to 850 cm | | |
| Width of the track | 21,6 cm | | | 28,6 cm | | |
| Inside width (cm) | Total height (m) | PC 10mm | PC 4mm | Total height (m) | PC 10mm | PC 4mm |
| 300 cm | 1,15 | 11.996,25 € | 13.887,16 € | 1,25 | 16.956,31 € | 20.542,06 € |
| 325 cm | 1,25 | 12.285,00 € | 14.221,42 € | 1,35 | 17.260,19 € | 20.876,32 € |
| 350 cm | 1,30 | 12.442,50 € | 14.403,75 € | 1,40 | 17.533,68 € | 21.423,30 € |
| 375 cm | 1,35 | 12.757,50 € | 14.768,40 € | 1,45 | 18.475,70 € | 21.909,50 € |
| 400 cm | 1,40 | 13.072,50 € | 15.133,05 € | 1,50 | 19.448,10 € | 22.729,97 € |
| 425 cm | 1,50 | 13.387,50 € | 15.497,70 € | 1,60 | 20.025,47 € | 23.641,60 € |
| 450 cm | 1,55 | 13.807,50 € | 15.983,91 € | 1,65 | 20.663,61 € | 24.036,64 € |
| 475 cm | 1,60 | 14.673,75 € | 16.986,70 € | 1,70 | 21.301,75 € | 25.616,79 € |
| 500 cm | 1,65 | 15.592,50 € | 18.050,27 € | 1,75 | 22.031,05 € | 27.257,73 € |
| Extension of the running track / 1 m | | 127,63 € | | | 158,02 € | |

| Number of segments | 4 segments | | | 5 segments | | |
|--------------------------------------|---------------------|-------------|-------------|----------------------|-------------|-------------|
| Length | from 851 to 1000 cm | | | from 1001 to 1150 cm | | |
| Width of the track | 28,6 cm | | | 35,6 cm | | |
| Inside width (cm) | Total height (m) | PC 10mm | PC 4mm | Total height (m) | PC 10mm | PC 4mm |
| 300 cm | 1,25 | 18.232,59 € | 22.091,83 € | 1,30 | 22.152,60 € | 28.564,40 € |
| 325 cm | 1,35 | 18.536,47 € | 22.456,48 € | 1,40 | 22.334,93 € | 28.959,44 € |
| 350 cm | 1,40 | 18.870,73 € | 23.033,84 € | 1,45 | 23.550,43 € | 29.384,86 € |
| 375 cm | 1,45 | 19.843,14 € | 23.580,82 € | 1,50 | 25.373,69 € | 30.266,11 € |
| 400 cm | 1,50 | 20.906,71 € | 24.431,68 € | 1,55 | 26.133,38 € | 31.512,00 € |
| 425 cm | 1,60 | 21.514,46 € | 25.434,47 € | 1,65 | 26.923,46 € | 32.241,30 € |
| 450 cm | 1,65 | 22.213,38 € | 25.859,90 € | 1,70 | 27.774,32 € | 32.879,44 € |
| 475 cm | 1,70 | 22.881,91 € | 27.531,22 € | 1,75 | 28.655,56 € | 34.246,89 € |
| 500 cm | 1,75 | 23.702,37 € | 29.293,70 € | 1,80 | 29.597,58 € | 36.465,19 € |
| Extension of the running track / 1 m | | 158,02 € | | | 188,40 € | |

Oxygon Aegean® Pool Cover

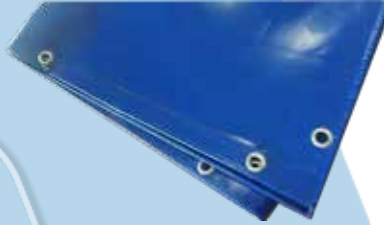

Our, Aegean Pool Cover, is the best winter pool cover for your pool as it provides 100% shade to inhibit algae growth. Your pool liner will be protected from stains, debris, and algae through the long off-season.

A strong and tightly covered pool is a must and the strength of the material used is also important. Our mesh pool covers allow water to flow through them and generally require no work during the off-season.

During the off-season or when you are not using the pool for long periods of time, we protect your pool against the elements of mother nature or unauthorized children and pets.

| CODE | SHAPE | DESCRIPTION | PRICE / m ² |
|------------|-------------|-------------|------------------------|
| 203.11.180 | Rectangular | Bordered | 54.02€ |
| 203.11.181 | Free Shape | Bordered | 57.62€ |

Sundown Pool Cover

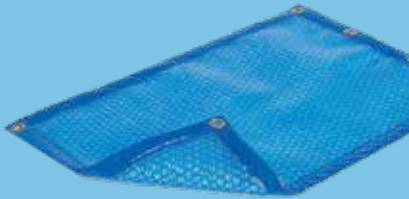

Features:

- 400 microns thick polyethylene film, blue bubbles (material naturally subject to variation of dimensions, around 1%).
- Ideal for indoor pools.
- Antioxidant treatment to avoid any deterioration of polyethylene by chlorine.
- Weight 370 g/m² (+/- 10%).
- Several manufacturing finishes: non bordered, bordered on 2 widths, fully bordered.
- Anti-UV treatment.

| CODE | SHAPE | DESCRIPTION | PRICE / m ² |
|------------|-------------|--------------|------------------------|
| 203.11.153 | Rectangular | Non bordered | 26.10€ |
| 203.11.154 | Geometrical | Non bordered | 26.70€ |
| 203.11.155 | Free form | Non bordered | 35.25€ |
| 203.11.156 | Rectangular | Bordered | 36.86€ |
| 203.11.157 | Geometrical | Bordered | 44.75€ |
| 203.11.158 | Free form | Bordered | 52.35€ |

Isothermal Bubble Cover Roll



Features:

- GEOBUBBLE technology.
- 500 microns thick polyethylene film.
- Anti-UV treatment, transparent
- Light blue colour.
- 50 m roll in 4 m or 5 m width.

| CODE | DESCRIPTION | WIDTH | PRICE / m ² |
|------------|-------------|-------|------------------------|
| 203.11.179 | 50m Roll | 5 m | 21.35€ |

Tempo Cover



The New Generation of Pool Covers

Designed and entirely produced by Oxygon in Greece, the Tempo Cover offers exceptional durability, strength, and convenience for your pool.

- Custom-Made Fit – Manufactured to perfectly match your pool's dimensions.
- Reinforced Structure – Sturdy aluminum bars every 1m for maximum durability.
 - Heavy-Duty Straps – Extra-strong ιμάντες ensure secure closure.
- Smart Water Drainage – Net sections between the bars prevent rainwater from accumulating.
 - Aesthetic & Practical – Available in a variety of colors to suit your style.

Oxygon TEMPO – Strength, Style & Protection in One Cover!



| CODE | DESCRIPTION | PRICE / m ² |
|------------|-----------------------------|------------------------|
| 203.11.192 | Tempo Cover | 140,00€ |
| 203.11.193 | Set of Stripe and Tensioner | 54,50€ |

Automatic Pool Cover



The Oxygen Aegean Pool Cover System is a premium solution for enhancing safety, energy efficiency, and aesthetics in residential and commercial swimming pools. Designed for pools up to 10x20 meters, this system provides superior protection while maintaining a sleek and modern appearance.

Key Features:

- Versatile Installation: Suitable for both in-pool (underwater) and above-ground (off-the-water) configurations.
- Reliable & Powerful Motor: Ensures smooth and efficient operation with minimal effort.
- Easy Installation & Adjustment: Engineered for quick setup and hassle-free alignment.
- Low Maintenance: Designed with durability in mind, requiring minimal upkeep.
- Standard Torque Limiter: Ensures optimal safety and performance for pools up to 8x12 meters.
- Premium Polycarbonate Slats: Provide excellent durability, UV resistance, and thermal insulation.

Whether you need a fully integrated in-pool cover or a stylish above-ground system, the Oxygen Aegean Pool Cover delivers performance, protection, and peace of mind.

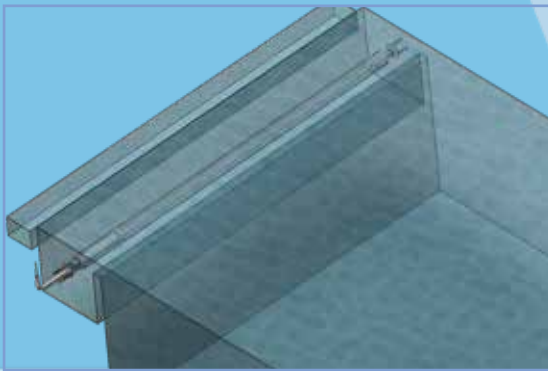

| CODE | SHAPE | DESCRIPTION | PRICE |
|------------|-------------|-------------|--------------|
| 203.11.191 | Rectangular | Auto Cover | Upon Request |

Telescopic Cover Rollers



Effortlessly manage your pool cover with the Oxygen Manual Telescopic Cover Roller—the perfect solution for folding and unfolding Bubble or Aegean covers.

- Lightweight & Durable – Made of high-quality aluminum for long-lasting performance.
 - Adjustable Width – Easily adapts to fit different pool sizes.
- Smooth Mobility – Equipped with wheels for easy movement and positioning.

Enjoy hassle-free pool cover handling with Oxygen's efficient and practical design!

| CODE | DESCRIPTION | DIAMETER | DIMENSION RANGE | STRAPS | PRICE |
|-----------|----------------------|----------|-----------------|--------|-----------|
| 104.11.04 | Telescopic Tube 2545 | Ø110 | 2,5m - 4,5m | 4 | 831.71€ |
| 104.11.05 | Telescopic Tube 4357 | Ø110 | 4,3m - 5,7m | 6 | 990.50€ |
| 104.11.06 | Telescopic Tube 5369 | Ø110 | 5,3m - 6,9m | 8 | 1,011.29€ |

Pair of Movable support, with wheels only by one side, 50cm height

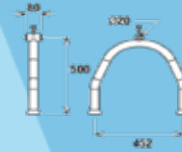
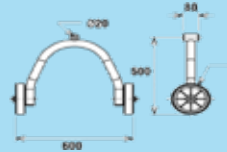

| CODE | DESCRIPTION | PRICE |
|-----------|-----------------|---------|
| 104.11.08 | Movable Support | 369.37€ |

Pool Fence

At Oxygen, we understand that safety around the pool is more important than ever. As people become increasingly concerned about pool safety, we're seeing growing interest and positive feedback on our high-quality pool fences — and for good reason!

Our pool fences are specifically designed to prevent children or pets from accidentally falling into the pool, offering peace of mind to families while maintaining a stylish, modern look around your swimming area.

- Quick to install
- Removable when needed
- Durable and resistant to pool environments
- Discreet and elegant design that blends in with any backyard

With rising demand and customer satisfaction on the rise, it's clear: a safe pool is a happy pool. Choose Oxygen's pool fence solution — and make safety a beautiful part of your pool area.



Pool Fence Kit

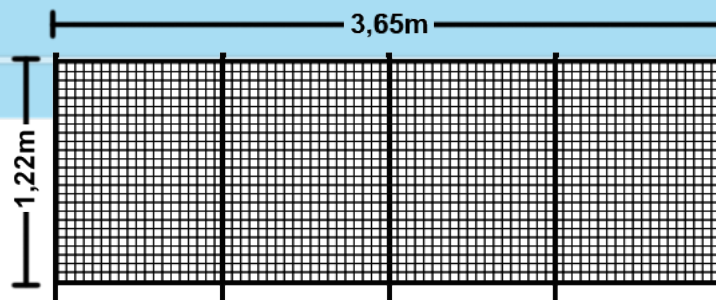

Pool Fence Door

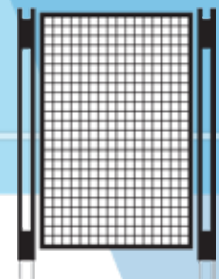

| CODE | DESCRIPTION | DIMENSION RANGE | PRICE |
|-----------|-----------------|-----------------|---------|
| 750.09.33 | Pool Fence Kit | 3,65m - 1,22m | 299.00€ |
| 750.09.34 | Pool Fence Door | 0,80m - 1,22m | 395.00€ |



Sports Equipment

Strem-On



Stream-ON Counter Current System – Endless Swimming & Relaxation
Transform any pool into a limitless training or relaxation space with Oxygen's Stream-ON Counter Current System.

- Flexible Installation – Suitable for both skimmer and overflow pools, with no prior infrastructure required.
- Fully Adjustable – Customize the flow to match your pace – perfect for beginners and experienced swimmers alike.
- Works in Any Pool Size – Designed to deliver a smooth, consistent swim experience, regardless of pool dimensions.

Enjoy the freedom of open-water swimming, right in your own pool, with Oxygen's innovative Stream-ON technology!

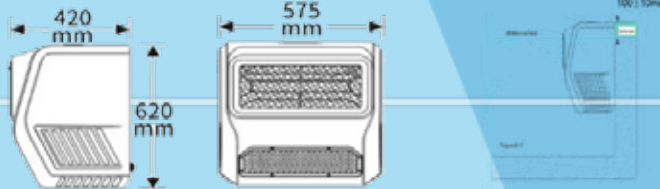

| CODE | POWER SUPPLY | kW | Stream Flow | MAX FLOW | PRICE |
|-----------|--------------|-----|-------------|-----------|------------|
| 104.26.15 | 220-240V | 1,6 | 510 m3/h | 1,6 m/sec | 10,500.00€ |

Jester



Infinite variable speeds that can be adjusted by the user through the unit's controller or by a mobile app according to his needs

- Easy to install with just 4 screws
- Safe to operate with a DC 36V power
- Low noise, no vibrations
- Compact inovative design
- Made with enviromental friendly materials and UV protection
- I deal both for new or already made swimming pools



Διαστάσεις / Dimensions

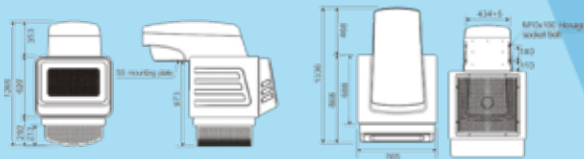

| CODE | POWER SUPPLY | kW | Stream Flow | MAX FLOW | PRICE |
|------------|--------------|----|-------------|-----------|------------|
| 106.07.291 | 380V | 3 | 1000 m3/h | 186 m/min | 18,944.59€ |
| 106.07.292 | 380V | 4 | 1300 m3/h | 240 m/min | 22,395.34€ |

Amber

A powerful circulator with both powerful and economical motor and thermoplastic housing. After production, each pump is tested.

The main advantages of the model are:

- High-tech motor
- Stable posture
- Drain plug included
- Thermoplastic housing
- Suitable for liner swimming pools

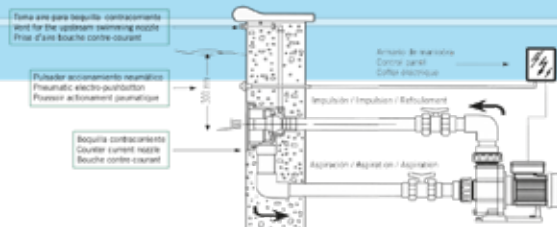
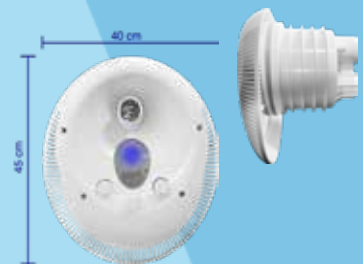
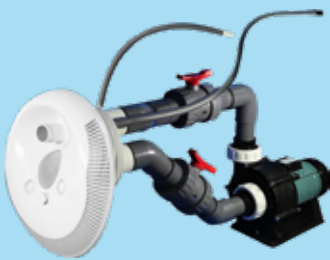

| CODE | DESCRIPTION | hP | kW | POWER | Q max | H | PRICE |
|------------|----------------|-----|-----|-------|---------|-----|-----------|
| 106.07.301 | System 30 | 3 | 2,2 | 220V | 42 m3/h | 8 m | 3,725.09€ |
| 106.07.293 | System 35 | 3,5 | 2,5 | 400V | 46 m3/h | 8 m | 3,800.82€ |
| 106.07.294 | System 40 | 4,0 | 3,0 | 400V | 68 m3/h | 8 m | 3,945.75€ |
| 106.07.295 | System 55 | 5,5 | 4,0 | 400V | 84 m3/h | 8 m | 4,090.72€ |
| 106.07.296 | Head with base | - | - | - | - | - | 1,535.59€ |

Competition Lane Moscow Type



Moscow float lines are consisted combination of:

Float ball/anti-waving disk floater/float ball. The float lines distinguish the pool lanes for the swimmers and according to the international regulations the first and final 5m of floaters of the Moscow line are usually made in red or orange colour combined with white balls. The intermediate meters are coloured white combined with red or orange coloured balls. The special design of the disks allows them to rotate independently. The lines are supplied already assembled, ready to be positioned and anchored in the water.

| CODE | MODEL | PRICE/m |
|-----------|-----------------------------------|---------|
| 104.21.12 | Moscow Lane, Disk Ø150, Ball Ø120 | 39.01€ |

Competition Lane Reel

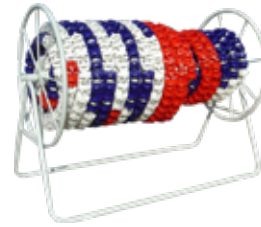

Stainless Steel (AISI-316) lane reel for storing the floating lanes. Special wheel with handrail able to store up to 100m of Ø140 lanes. The reel stands on two triangle bases -one on each side- which provides maximum stability. Also it can be supplied with wheels for more easy and fast movement an store. Suitable for 4X25m of Ø140 lanes or 2X50m of Ø140 lanes

| CODE | DESCRIPTION | PRICE |
|-----------|--------------------|-----------|
| 104.21.13 | Floating Lane Reel | 4,485.98€ |

Competition Starting Boards



Starting diving board for competition swimming pools, available in 400mm or 700mm featuring a single step. The body is made of corrosion resistant stainless steel AISI-316 and it's platform 50x50cm top designed to provide added stability for fast and secure takeoffs is made of polyester mixed with fibelglass for extra duability. Due to its adjustable platform, it can be also set in a slightly different position (200mm front/back). Front hand grip for the swimmer, platform under special "sand finish" construction to effect an anti-slipping surface of superior traction and performance, and chemical upat-connections are included.

| CODE | MODEL | PRICE |
|-----------|--------|-----------|
| 104.21.16 | STB400 | 1,832.34€ |
| 104.21.17 | STB700 | 2,498.35€ |

Release Rope



Support posts at 1,80m height and Ø43 diameter, made of heavy duty stainless steel AISI-316. They feature a bracket for the rope's steady and stretched tightening above the pool and also include assembled red or white triangular flags made of long-lasting waterproof fiber.

| CODE | DESCRIPTION | PRICE |
|-----------|--|---------|
| 104.21.27 | RFI-125 Release Rope with Flags, 12,5m | 90.58€ |
| 104.21.28 | RFI-210 Release Rope with Flags, 21,0m | 148.38€ |



Stainless Steel hook for stable gripping of float line to the edge of the pool



Stainless Steel wall anchor cup designed to hold float lines. For swimming pools with skimmers



Stainless Steel anchor for float lines that is also a base for turning panels. It is used for swimming pools with overflow system



Stainless Steel tensor for anchoring the float line on the anchor base.

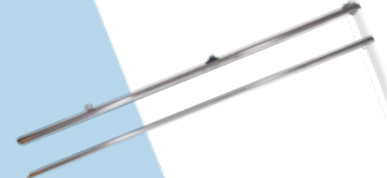

False start posts are support posts, 1,80m height and Ø43mm diameter. Made of heavy duty stainless steel AISI-316.

| CODE | 104.21.18 | CODE | 104.21.19 | CODE | 104.21.20 | CODE | 104.21.21 | CODE | DESCRIPTION | PRICE |
|-------|-----------|-------|-----------|-------|-----------|-------|-----------|-----------|--------------|---------|
| PRICE | 23.82€ | PRICE | 169.08€ | PRICE | 148.38€ | PRICE | 227.75€ | 104.21.23 | PPP-180 Post | 224.30€ |
| | | | | | | | | 104.21.24 | PPB-180 Post | 224.30€ |

Diving Boards DB180-200-240



Features:

- Polyester with fiberglass board
- Polyester with fiberglass
- Anti-slip board surface
- Available lengths: 1,80m, 2,00m, 2,40m
- Light blue color

| CODE | MODEL | PRICE |
|-----------|--------|-----------|
| 104.21.30 | DB 180 | 1,207.77€ |
| 104.21.31 | DB 200 | 1,294.03€ |
| 104.21.32 | DB 240 | 1,466.58€ |

Diving Board SB

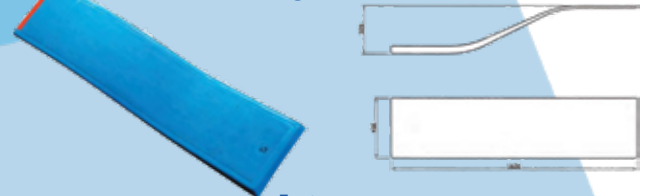

Features:

- Polyester with fiberglass board
- Anchoring unit for deck mounting
- Anti-slip board surface
- Available lengths: 1,60m
- Light blue color

| CODE | MODEL | PRICE |
|-----------|-------|-----------|
| 104.21.33 | SB | 1,207.77€ |

PK3 Series Pool Lift



Features:

- Approved to lift up to 120 kg.
- A 3,5 bar water inlet pressure is needed for its operation.
 - Rotation: 170° clockwise.
 - Turning radius: 700 mm
- The control is on the user's right
(if the opposite is needed, you must specify it in your order).
- The seat allows 1,6 m. of vertical movement.
 - The seat can easily be taken apart.

| CODE | MODEL | PRICE |
|-----------|-------------------------|------------|
| 104.21.34 | PK3 pool lift for 120kg | 15,493.86€ |
| 104.21.35 | PK3 pool lift for 150kg | 17,219.22€ |

B2 Series Pool Lift



Features:

- Approved to lift up to 150 and 120 kg
- A 5,5 bar water inlet is necessary to lift 150 kg
 - 3,5 bar are needed to lift 120 Kg
 - Rotation: 170° clockwise.
 - Turning radius: 700 mm
- The control is on the user's right
- The height adjustable seat allows 1,6 m. of vertical movement. It is normally placed +0,53 m. above water level and -0,53 m. below water level.
- It can be adapted to any kind of pool as all its parts are adjustable

| CODE | MODEL | PRICE |
|-----------|------------------------|------------|
| 104.21.45 | B2 pool lift for 120kg | 17,219.22€ |
| 104.21.46 | B2 pool lift for 150kg | 18,944.59€ |

3000-3600 Series Pool Lift



Features:

- Lacquered Aisi 316 stainless steel device with electrical mechanism (24 V battery)
- Base platform for anchoring to the ground or wall.
 - Economy model
 - Only vertical movement
 - User assisted
- Designed for above ground swimming pools, spa

| CODE | MODEL | PRICE |
|-----------|----------------|--------------|
| 104.21.38 | 3000 pool lift | Upon Request |
| 104.21.39 | 3400 pool lift | Upon Request |
| 104.21.40 | 3600 pool lift | Upon Request |

400-600 Series Pool Lift



Features:

- Designed to facilitate independent access to swimming pools
- Base platform with counterweights and 4 wheels, 2 of which can rotate
- Transportable, meaning the lift can be used at any point of the pool and be stored when not in use
 - Approx. weight 170 kg.
 - Lifting capacity: 120 kg
- Vertical lift of the seat: 1.10 m
 - 2 batteries + charger
 - Removable seat
 - Foldable arm rests
 - Adjustable foot rest
- Made from lacquered stainless steel

| CODE | MODEL | PRICE |
|-----------|-------------------------|------------|
| 104.21.41 | 400 pool lift for 120kg | 24,120.72€ |
| 104.21.42 | 400 pool lift for 150kg | 27,571.46€ |
| 104.21.43 | 600 pool lift for 120kg | 20,669.98€ |
| 104.21.44 | 600 pool lift for 150kg | 24,120.72€ |



Pool Decoration

OXYGON⁺

DECK-WPC FLOOR DARK BROWN 110

Deck WPC synthetic outdoor flooring composed of 55% wood and 35% HDPE and 10% resins, UV stabilizers etc. It is double sided with narrow comb on one side and wide on the other. Ideal choice for swimming pool floor, terrace, outdoor areas of shops, gardens, marinas, etc.

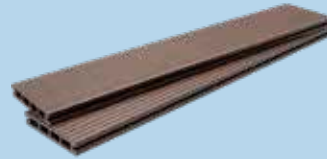

- High resistance to the organisms that attack natural wood (e.g. woodworm, etc.)
- Long lifespan
- Anti-slip
- Resistance to abrasion
- Ignition resistance
- Waterproof
- Resistance to solar radiation
- Thermal insulation (from -40°C to 70°C)
- Warranty: 5 years

| CODE | DESCRIPTION | DIMENSION | Kg | PRICE / m ² |
|-----------|----------------------|-----------------|----|------------------------|
| 761.00.52 | DECK-WPC D.Brown 110 | 25 X 146 X 3600 | 10 | 98.88€ |

DECK-WPC FLOOR DARK GREY 50

Deck WPC synthetic outdoor flooring composed of 55% wood and 35% HDPE and 10% resins, UV stabilizers etc. It is double sided with narrow comb on one side and wide on the other. Ideal choice for swimming pool floor, terrace, outdoor areas of shops, gardens, marinas, etc.

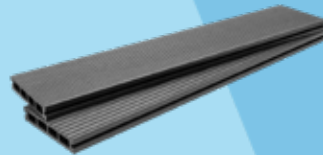
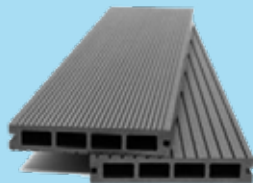

- High resistance to the organisms that attack natural wood (e.g. woodworm, etc.)
- Long lifespan
- Anti-slip
- Resistance to abrasion
- Ignition resistance
- Waterproof
- Resistance to solar radiation
- Thermal insulation (from -40°C to 70°C)
- Warranty: 5 years

| CODE | DESCRIPTION | DIMENSION | Kg | PRICE / m ² |
|-----------|--------------------|-----------------|----|------------------------|
| 761.00.53 | DECK-WPC D.Grey 50 | 25 X 146 X 3600 | 10 | 98.88€ |

DECK-WPC FLOOR OAK NAT 150

Deck WPC synthetic outdoor flooring composed of 55% wood and 35% HDPE and 10% resins, UV stabilizers etc. It is double sided with narrow comb on one side and wide on the other. Ideal choice for swimming pool floor, terrace, outdoor areas of shops, gardens, marinas, etc.



- High resistance to the organisms that attack natural wood (e.g. woodworm, etc.)
- Long lifespan
- Anti-slip
- Resistance to abrasion
- Ignition resistance
- Waterproof
- Resistance to solar radiation
- Thermal insulation (from -40°C to 70°C)
- Warranty: 5 years

| CODE | DESCRIPTION | DIMENSION | Kg | PRICE / m ² |
|-----------|----------------------|-----------------|----|------------------------|
| 761.00.54 | DECK-WPC Oak Nat 150 | 25 X 146 X 3600 | 10 | 98.88€ |

DECK-WPC FLOOR LIGHT BROWN 40

Deck WPC synthetic outdoor flooring composed of 55% wood and 35% HDPE and 10% resins, UV stabilizers etc. It is double sided with narrow comb on one side and wide on the other. Ideal choice for swimming pool floor, terrace, outdoor areas of shops, gardens, marinas, etc.



- High resistance to the organisms that attack natural wood (e.g. woodworm, etc.)
- Long lifespan
- Anti-slip
- Resistance to abrasion
- Ignition resistance
- Waterproof
- Resistance to solar radiation
- Thermal insulation (from -40°C to 70°C)
- Warranty: 5 years

| CODE | DESCRIPTION | DIMENSION | Kg | PRICE / m ² |
|-----------|-------------------------|-----------------|----|------------------------|
| 761.00.55 | DECK-WPC Light Brown 40 | 25 X 146 X 3600 | 10 | 98.88€ |

DECK-WPC FLOOR LIGHT GREY 180

Deck WPC synthetic outdoor flooring composed of 55% wood and 35% HDPE and 10% resins, UV stabilizers etc. It is double sided with narrow comb on one side and wide on the other. Ideal choice for swimming pool floor, terrace, outdoor areas of shops, gardens, marinas, etc.

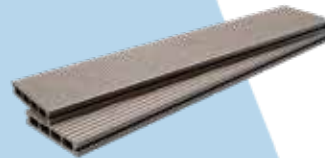

- High resistance to the organisms that attack natural wood (e.g. woodworm, etc.)
- Long lifespan
- Anti-slip
- Resistance to abrasion
- Ignition resistance
- Waterproof
- Resistance to solar radiation
- Thermal insulation (from -40°C to 70°C)
- Warranty: 5 years

| CODE | DESCRIPTION | DIMENSION | Kg | PRICE / m ² |
|-----------|-------------------------|-----------------|----|------------------------|
| 761.00.56 | DECK-WPC Light Grey 180 | 25 X 146 X 3600 | 10 | 98.88€ |

DECK-WPC FLOOR WHITE 130

Deck WPC synthetic outdoor flooring composed of 55% wood and 35% HDPE and 10% resins, UV stabilizers etc. It is double sided with narrow comb on one side and wide on the other. Ideal choice for swimming pool floor, terrace, outdoor areas of shops, gardens, marinas, etc.



- High resistance to the organisms that attack natural wood (e.g. woodworm, etc.)
- Long lifespan
- Anti-slip
- Resistance to abrasion
- Ignition resistance
- Waterproof
- Resistance to solar radiation
- Thermal insulation (from -40°C to 70°C)
- Warranty: 5 years

| CODE | DESCRIPTION | DIMENSION | Kg | PRICE / m ² |
|-----------|--------------------|-----------------|----|------------------------|
| 761.00.57 | DECK-WPC White 130 | 25 X 146 X 3600 | 10 | 98.88€ |

DECK-WPC FLOOR
WOOD IMITATION DARK GREY 8050

Deck WPC synthetic outdoor flooring composed of 55% wood and 35% HDPE and 10% resins, UV stabilizers etc. It is double sided with narrow comb on one side and wide on the other. Ideal choice for swimming pool floor, terrace, outdoor areas of shops, gardens, marinas, etc.

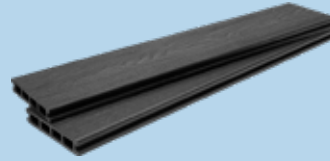
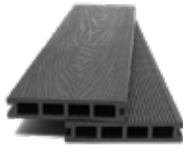

- High resistance to the organisms that attack natural wood (e.g. woodworm, etc.)
- Long lifespan
- Anti-slip
- Resistance to abrasion
- Ignition resistance
- Waterproof
- Resistance to solar radiation
- Thermal insulation (from -40°C to 70°C)
- Warranty: 5 years

| CODE | DESCRIPTION | DIMENSION | Kg | PRICE / m ² |
|-----------|-------------------------|-----------------|-----|------------------------|
| 761.00.58 | DECK-WPC Dark Grey 8050 | 25 X 146 X 3600 | 9,5 | 108.15€ |

DECK-WPC FLOOR
WOOD IMITATION DARK BROWN 80110

Deck WPC synthetic outdoor flooring composed of 55% wood and 35% HDPE and 10% resins, UV stabilizers etc. It is double sided with narrow comb on one side and wide on the other. Ideal choice for swimming pool floor, terrace, outdoor areas of shops, gardens, marinas, etc.

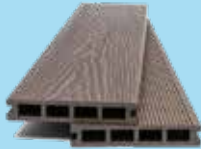

- High resistance to the organisms that attack natural wood (e.g. woodworm, etc.)
- Long lifespan
- Anti-slip
- Resistance to abrasion
- Ignition resistance
- Waterproof
- Resistance to solar radiation
- Thermal insulation (from -40°C to 70°C)
- Warranty: 5 years

| CODE | DESCRIPTION | DIMENSION | Kg | PRICE / m ² |
|-----------|---------------------------|-----------------|-----|------------------------|
| 761.00.59 | DECK-WPC Dark Brown 80110 | 25 X 146 X 3600 | 9,5 | 108.15€ |

DECK-WPC FLOOR
WOOD IMITATION LIGHT BROWN 8040

Deck WPC synthetic outdoor flooring composed of 55% wood and 35% HDPE and 10% resins, UV stabilizers etc. It is double sided with narrow comb on one side and wide on the other. Ideal choice for swimming pool floor, terrace, outdoor areas of shops, gardens, marinas, etc.



- High resistance to the organisms that attack natural wood (e.g. woodworm, etc.)
- Long lifespan
- Anti-slip
- Resistance to abrasion
- Ignition resistance
- Waterproof
- Resistance to solar radiation
- Thermal insulation (from -40°C to 70°C)
- Warranty: 5 years

| CODE | DESCRIPTION | DIMENSION | Kg | PRICE / m ² |
|-----------|---------------------------|-----------------|-----|------------------------|
| 761.00.60 | DECK-WPC Light Brown 8040 | 25 X 146 X 3600 | 9,5 | 108.15€ |

DECK-WPC FLOOR WOOD IMITATION LIGHT GREY 80180

Deck WPC synthetic outdoor flooring composed of 55% wood and 35% HDPE and 10% resins, UV stabilizers etc. It is double sided with narrow comb on one side and wide on the other. Ideal choice for swimming pool floor, terrace, outdoor areas of shops, gardens, marinas, etc.

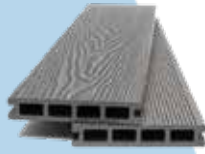

- High resistance to the organisms that attack natural wood (e.g. woodworm, etc.)
- Long lifespan
- Anti-slip
- Resistance to abrasion
- Ignition resistance
- Waterproof
- Resistance to solar radiation
- Thermal insulation (from -40°C to 70°C)
- Warranty: 5 years

| CODE | DESCRIPTION | DIMESNION | Kg | PRICE / m ² |
|-----------|---------------------------|-----------------|-----|------------------------|
| 761.00.61 | DECK-WPC Light Grey 80180 | 25 X 146 X 3600 | 9,5 | 108.15€ |

DECK-WPC FLOOR WOOD IMITATION TEAK 80155

Deck WPC synthetic outdoor flooring composed of 55% wood and 35% HDPE and 10% resins, UV stabilizers etc. It is double sided with narrow comb on one side and wide on the other. Ideal choice for swimming pool floor, terrace, outdoor areas of shops, gardens, marinas, etc.



- High resistance to the organisms that attack natural wood (e.g. woodworm, etc.)
- Long lifespan
- Anti-slip
- Resistance to abrasion
- Ignition resistance
- Waterproof
- Resistance to solar radiation
- Thermal insulation (from -40°C to 70°C)
- Warranty: 5 years

| CODE | DESCRIPTION | DIMESNION | Kg | PRICE / m ² |
|-----------|---------------------|-----------------|-----|------------------------|
| 761.00.62 | DECK-WPC Teak 80155 | 25 X 146 X 3600 | 9,5 | 108.15€ |

DECK-WPC FLOOR TILES 12 X 300 X 300

Composite deck WPC outdoor tile consisting of 60% wood and 40% HDPE, resins, UV stabilizers, etc. It has a built-in PVC base for easy installation and assembly. Ideal choice for swimming pool floor, terrace, outdoor areas of shops, gardens, marinas, etc.

Light Grey 180

Oak Nat 150



Natural characteristics

- High resistance to the organisms that attack natural wood (e.g. woodworm, etc.)
 - Long lifespan
 - Anti-slip
 - Abrasion resistance
 - Resistance to ignition
 - Waterproof
 - Resistance to solar radiation
- Thermal insulation (from -40 °C to 70 °C)

| CODE | DESCRIPTION | DIMESNION | PRICE / m ² |
|-----------|-------------------------------|----------------|------------------------|
| 761.00.63 | DECK-WPC Tiles Light Grey 180 | 12 X 300 X 300 | 108.15€ |
| 761.00.64 | DECK-WPC Tiles Oak Nat 150 | 12 X 300 X 300 | 108.15€ |

DECK-WPC CORNERS

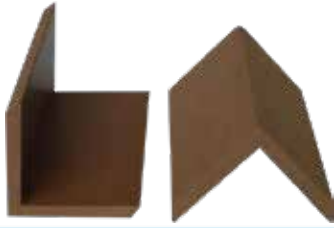

WPC material corner to finish our floor in the best way. It is placed on the finish and is usually screwed or glued. The "C" shaped profiles can also be used as a stair overhang (with a contrasting colour), offering a visible sign at the ends of the stairs. They have a natural look and match perfectly with the Deck WPC floor.

| CODE | DESCRIPTION | DIMESNION | PRICE / pcs |
|-----------|----------------------------------|----------------|-------------|
| 761.00.65 | Corner for DARK BROWN 110 DECK | 40 X 40 X 3600 | 5.67€ |
| 761.00.66 | Corner for DARK GREY 50 DECK | 40 X 40 X 3600 | 5.67€ |
| 761.00.67 | Corner for OAK NAT 150 DECK | 40 X 40 X 3600 | 5.67€ |
| 761.00.68 | Corner for LIGHT BROWN 40 DECK | 40 X 40 X 3600 | 5.67€ |
| 761.00.69 | Corner for LIGHT GREY 180 DECK | 40 X 40 X 3600 | 5.67€ |
| 761.00.70 | Corner for WHITE 130 DECK | 45 X 45 X 3600 | 5.67€ |
| 761.00.71 | Corner for DARK GREY 8050 DECK | 50 X 55 X 3600 | 5.67€ |
| 761.00.72 | Corner for DARK BROWN 80110 DECK | 50 X 55 X 3600 | 5.67€ |
| 761.00.73 | Corner for LIGHT BROWN 8040 DECK | 50 X 55 X 3600 | 5.67€ |
| 761.00.74 | Corner for LIGHT GREY 80180 DECK | 50 X 55 X 3600 | 5.67€ |
| 761.00.75 | Corner for TEAK 80155 DECK | 50 X 55 X 3600 | 5.67€ |

DECK-WPC Supporting Board



Composite board for the Deck WPC synthetic planks installation infrastructure.

It is specially made for WPC synthetic products and thus the best possible result is achieved in our constructions. Suitable for outdoor use without being corroded by weather conditions and moisture. The factory recommends that the tiles be placed every 30 - 35 cm to avoid scratching the floor. The starting and joining clips are applied to the surface of the frame.

| CODE | DESCRIPTION | DIMESNION | PRICE / Linear mr |
|-----------|-------------------|----------------|-------------------|
| 761.00.76 | DECK-WPC Board 50 | 40 X 30 X 3600 | 6.18€ |

DECK-WPC Accesories



Start / End Clip



Deck Ending Clip



Intermediate Clip



Spa / Sauna / Steam Bath
Fiberglass Pool

OXYGON⁺

OX 6001

DIMENSIONS: 2300 X 2300 X 880

Seating

2 loungers & 3 seats

Shell

Shell colours 7 colours options
Shell material Mitsubishi JP

Pumps

Circulation Pump 1 X 0,35hp
Jet Pump 2 X 3hp

Dimensions

Product Dimension 2300 X 2300 X 880
Dry Weight 390kg
Weight with Water 2190kg

Features

Suction 4 pcs
Drainage Outlet 1 pc
Headrest pillows (pcs) 3 pcs
Support frame Aluminum (40mm X 20mm)
Skirt ABS Corner + new PS
Shell insulation 1 cm
Base ABS with EVA

Electric components

Control system Gecko +3kW Heater
Power supply 220V/380V/110V
Underwater Lighting 1 pc

Jet Configuration

Total Jets 58 pcs
Hydrotherapy Jets 5" -
Hydrotherapy Jets 4" 8 pcs
Hydrotherapy Jets 3" 4 pcs
Hydrotherapy Jets 2,5" 4 pcs
Hydrotherapy Jets 2" 42 pcs
Hydrotherapy Jets 1" -

Filtration

Filter 1 pc, 1 X 100sf
OZON Sterilizer 1 pc



OX 6005

DIMENSIONS: 2000 X 2000 X 820



Seating

2 loungers & 3 seats

Shell

Shell colours 7 colours options
Shell material Mitsubishi JP

Pumps

Circulation Pump / Jet Pump 1 X 0,35hp / 2,00hp
Jet Pump -

Dimensions

Product Dimension 2000 X 2000 X 820
Dry Weight 300kg
Weight with Water 1600kg

Features

Suction 3 pcs
Drainage Outlet 1 pc
Headrest pillows (pcs) 3 pcs
Support frame Aluminum (40mm X 20mm)
Skirt new PS
Shell insulation 1 cm
Base ABS with EVA

Control system Gecko +3kW Heater
Power supply 220V/380V/110V
Underwater Lighting 1 pc

Jet Configuration

Total Jets 34 pcs
Hydrotherapy Jets 5" -
Hydrotherapy Jets 4" 2 pcs
Hydrotherapy Jets 3" 6 pcs
Hydrotherapy Jets 2,5" -
Hydrotherapy Jets 2" 26 pcs
Hydrotherapy Jets 1" -

Filtration

Filter 1 pc, 1 X 100sf
OZON Sterilizer 1 pc



OX 6006

DIMENSIONS: 2000 X 2000 X 820

| | |
|----------------------------|------------------------|
| Seating | |
| 1 lounger & 5 seats | |
| Shell | |
| Shell colours | 7 colours options |
| Shell material | Mitsubishi JP |
| Pumps | |
| Circulation Pump | 1 X 0,35hp |
| Jet Pump | 1 x 3hp |
| Dimensions | |
| Product Dimension | 2000 X 2000 X 820 |
| Dry Weight | 300kg |
| Weight with Water | 1600kg |
| Features | |
| Suction | 3 pcs |
| Drainage Outlet | 1 pc |
| Headrest pillows (pcs) | 3 pcs |
| Support frame | Aluminum (40mm X 20mm) |
| Skirt | new PS |
| Shell insulation | 1 cm |
| Base | ABS with EVA |
| Electric components | |
| Control system | Gecko +3kW Heater |
| Power supply | 220V/380V/110V |
| Underwater Lighting | 1 pc |
| Jet Configuration | |
| Total Jets | 33 pcs |
| Hydrotherapy Jets 5" | - |
| Hydrotherapy Jets 4" | 2 pcs |
| Hydrotherapy Jets 3" | 8 pcs |
| Hydrotherapy Jets 2,5" | - |
| Hydrotherapy Jets 2" | 23 pcs |
| Hydrotherapy Jets 1" | - |
| Filtration | |
| Filter | 1 pc, 1 X 100sf |
| OZON Sterilizer | 1 pc |



OX 6007

DIMENSIONS: 2300 X 2300 X 880

| | |
|----------------------------|-------------------|
| Seating | |
| 7 seats | |
| Shell | |
| Shell colours | 7 colours options |
| Shell material | Mitsubishi JP |
| Pumps | |
| Circulation Pump | 1 X 0,35hp |
| Jet Pump | 2 x 3hp |
| Dimensions | |
| Product Dimension | 2300 X 2300 X 880 |
| Dry Weight | 410kg |
| Weight with Water | 2210kg |
| Features | |
| Suction | 4 pcs |
| Drainage Outlet | 1 pc |
| Headrest pillows (pcs) | 4 pcs |
| Support frame | Timber |
| Skirt | new PS |
| Shell insulation | 1 cm |
| Base | ABS |
| Electric components | |
| Control system | Gecko +3kW Heater |
| Power supply | 220V/380V/110V |
| Underwater Lighting | 1 pc |
| Jet Configuration | |
| Total Jets | 36 pcs |
| Hydrotherapy Jets 5" | 4 pcs |
| Hydrotherapy Jets 4" | 2 pcs |
| Hydrotherapy Jets 3" | - |
| Hydrotherapy Jets 2,5" | - |
| Hydrotherapy Jets 2" | 28 pcs |
| Hydrotherapy Jets 1" | 2 pcs |
| Filtration | |
| Filter | 1 pc, 1 X 100sf |
| OZON Sterilizer | 1 pc |





OX 7011

DIMENSIONS: 2180 X 1580 X 850

| | |
|----------------------------|------------------------|
| Seating | |
| 1 lounger & 2 seats | |
| Shell | |
| Shell colours | 7 colours options |
| Shell material | Mitsubishi JP |
| Pumps | |
| Circulation Pump | 1 X 0,35hp |
| Jet Pump | 1 x 3hp |
| Dimensions | |
| Product Dimension | 2180 X 1580 X 850 |
| Dry Weight | 260kg |
| Weight with Water | 1360kg |
| Features | |
| Suction | 2 pcs |
| Drainage Outlet | 1 pc |
| Headrest pillows (pcs) | 3 pcs |
| Support frame | Aluminum (40mm X 20mm) |
| Skirt | new PS |
| Shell insulation | 1 cm |
| Base | ABS with EVA |
| Electric components | |
| Control system | Gecko +3kW Heater |
| Power supply | 220V/380V/110V |
| Underwater Lighting | 1 pc |
| Jet Configuration | |
| Total Jets | 29 pcs |
| Hydrotherapy Jets 5" | - |
| Hydrotherapy Jets 4" | 6 pcs |
| Hydrotherapy Jets 3" | 4 pcs |
| Hydrotherapy Jets 2,5" | 15 pcs |
| Hydrotherapy Jets 2" | - |
| Hydrotherapy Jets 1" | 4 pcs |
| Filtration | |
| Filter | 1 pc, 1 X 100sf |
| OZON Sterilizer | 1 pc |



OX 7023

DIMENSIONS: 2075 X 2075 X 930

| | |
|----------------------------|--------------------------------|
| Seating | |
| 5 seats | |
| Shell | |
| Shell colours | 7 colours options |
| Shell material | Mitsubishi JP |
| Pumps | |
| Circulation Pump | 1 X 0,50hp |
| Jet Pump | 1 x 3hp |
| Dimensions | |
| Product Dimension | 2075X 2075 X 930 |
| Dry Weight | 335kg |
| Weight with Water | 1735kg |
| Features | |
| Suction | 1 pcs |
| Drainage Outlet | 1 pc |
| Headrest pillows (pcs) | - |
| Support frame | Solid Timber Frame |
| Skirt | new PS |
| Shell insulation | 1 cm |
| Base | ABS with EVA |
| Electric components | |
| Control system | Gecko +3kW Heater |
| Power supply | 220V/380V/110V |
| Underwater Lighting | 1 pc |
| Jet Configuration | |
| Total Jets | 34 pcs |
| Hydrotherapy Jets 5" | - |
| Hydrotherapy Jets 4" | 5 pcs |
| Hydrotherapy Jets 3" | 2 pcs |
| Hydrotherapy Jets 2,5" | 4 pcs |
| Hydrotherapy Jets 2" | - |
| Hydrotherapy Jets 1" | 23 pcs |
| Filtration | |
| Filter | 1 pc, 1 X 50 (Floating Filter) |
| OZON Sterilizer | 1 pc |



OX 7025

DIMENSIONS: 1900 X 1900 X 980

| | |
|----------------------------|-----------------------|
| Seating | |
| 5 seats | |
| Shell | |
| Shell colours | 7 colours options |
| Shell material | Mitsubishi JP |
| Pumps | |
| Circulation Pump | 1 X 0,35hp |
| Jet Pump | 1 x 3hp |
| Dimensions | |
| Product Dimension | 1900 X 1900 X 980 |
| Dry Weight | 330kg |
| Weight with Water | 1930kg |
| Features | |
| Suction | 3 pcs |
| Drainage Outlet | 1 pc |
| Headrest pillows (pcs) | - |
| Support frame | Solid Antiseptic Wood |
| Skirt | new PS |
| Shell insulation | 2 cm |
| Base | ABS with EVA |
| Electric components | |
| Control system | Gecko +3kW Heater |
| Power supply | 220V/380V/110V |
| Underwater Lighting | 1 pc |
| Jet Configuration | |
| Total Jets | 19 pcs |
| Hydrotherapy Jets 5" | 1 pc |
| Hydrotherapy Jets 4" | 2 pcs |
| Hydrotherapy Jets 3" | 3 pcs |
| Hydrotherapy Jets 2,5" | 13 pcs |
| Hydrotherapy Jets 2" | - |
| Hydrotherapy Jets 1" | - |
| Filtration | |
| Filter | 1 pc, 1 X 50sf |
| OZON Sterilizer | 1 pc |

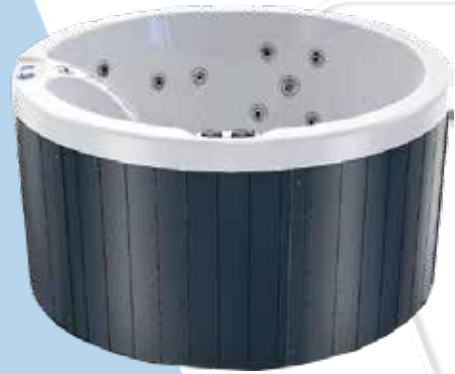

OX 7026

DIMENSIONS: 2250 X 2250 X 880

| | |
|----------------------------|------------------------|
| Seating | |
| 5 seats | |
| Shell | |
| Shell colours | 7 colours options |
| Shell material | Mitsubishi JP |
| Pumps | |
| Circulation Pump | 1 X 0,35hp |
| Jet Pump | 2 x 3hp |
| Dimensions | |
| Product Dimension | 2250 X 2250 X 880 |
| Dry Weight | 390kg |
| Weight with Water | 2090kg |
| Features | |
| Suction | 5 pcs |
| Drainage Outlet | 1 pc |
| Headrest pillows (pcs) | - |
| Support frame | Aluminum (40mm X 20mm) |
| Skirt | new PS |
| Shell insulation | 2 cm |
| Base | ABS |
| Electric components | |
| Control system | Gecko +3kW Heater |
| Power supply | 220V/380V/110V |
| Underwater Lighting | 1 pc |
| Jet Configuration | |
| Total Jets | 54 pcs |
| Hydrotherapy Jets 5" | - |
| Hydrotherapy Jets 4" | - |
| Hydrotherapy Jets 3" | 10 pcs |
| Hydrotherapy Jets 2,5" | 16 pcs |
| Hydrotherapy Jets 2" | 23 pcs |
| Hydrotherapy Jets 1" | 5 pcs |
| Filtration | |
| Filter | 1 pc, 1 X 100sf |
| OZON Sterilizer | 1 pc |



OX 7103

DIMENSIONS: 2000 X 1550 X 810

Seating

4 seats

Shell

Shell colours 7 colours options
Shell material Mitsubishi JP

Pumps

Circulation Pump 1 X 0,35hp
Jet Pump 1 x 3hp (two speed)

Dimensions

Product Dimension 2000 X 1550 X 810
Dry Weight 250kg
Weight with Water 1350kg

Features

Suction 2 pcs
Drainage Outlet 1 pc
Headrest pillows (pcs) 1 pc
Support frame Aluminum (40mm X 20mm)
Skirt new PS
Shell insulation 1 cm
Base ABS with PVC

Electric components

Control system Gecko +3kW Heater
Power supply 220V/380V/110V
Underwater Lighting 1 pc

Jet Configuration

Total Jets 32 pcs
Hydrotherapy Jets 5" -
Hydrotherapy Jets 4" -
Hydrotherapy Jets 3" 9 pcs
Hydrotherapy Jets 2,5" 2 pcs
Hydrotherapy Jets 2" 2 pcs
Hydrotherapy Jets 1" 17 pcs

Filtration

Filter 1 pc, 1 X 100sf
OZON Sterilizer 1 pc



OX 7105

DIMENSIONS: 1810 X 1810 X 770

Seating

4 seats

Shell

Shell colours 7 colours options
Shell material Mitsubishi JP

Pumps

Circulation Pump -
Jet Pump 1 x 2,5hp (two speed)

Dimensions

Product Dimension 1810 X 1810 X 770
Dry Weight 210kg
Weight with Water 1110kg

Features

Suction 1 pcs
Drainage Outlet 1 pc
Headrest pillows (pcs) -
Support frame Solid Timber Frame
Skirt new PS
Shell insulation 2 cm
Base ABS with PVC

Control system Gecko +3kW Heater
Power supply 220V/380V/110V
Underwater Lighting 1 pc

Jet Configuration

Total Jets 16 pcs
Hydrotherapy Jets 5" -
Hydrotherapy Jets 4" -
Hydrotherapy Jets 3" -
Hydrotherapy Jets 2,5" -
Hydrotherapy Jets 2" -
Hydrotherapy Jets 1" 16 pcs

Filtration

Filter 1 pc, 1 X 100sf
OZON Sterilizer 1 pc



OX 7106

DIMENSIONS: 1800 X 1640 X 800

Seating

1 lounge 2 seats

Shell

Shell colours 7 colours options
Shell material Mitsubishi JP

Pumps

Circulation Pump -
Jet Pump 1 x 2,5hp (two speed)

Dimensions

Product Dimension 1800 X 1640 X 800
Dry Weight 230kg
Weight with Water 1130kg

Features

Suction 1 pc
Drainage Outlet 1 pc
Headrest pillows (pcs) -
Support frame Aluminum (40mm X 20mm)
Skirt new PS
Shell insulation 2 cm
Base ABS with PVC

Electric components

Control system Gecko +3kW Heater
Power supply 220V/380V/110V
Underwater Lighting 1 pc

Jet Configuration

Total Jets 26 pcs
Hydrotherapy Jets 5" -
Hydrotherapy Jets 4" -
Hydrotherapy Jets 3" -
Hydrotherapy Jets 2,5" 6 pcs
Hydrotherapy Jets 2" -
Hydrotherapy Jets 1" 20 pcs

Filtration

Filter 1 pc, 1 X 50sf
OZON Sterilizer 1 pc



OX V01

DIMENSIONS: 2300 X 2300 X 880

Seating

2 Lounges & 3 seats

Shell

Shell colours 7 colours options
Shell material Mitsubishi JP

Pumps

Circulation Pump 1 X 0,35hp
Jet Pump 2 x 4hp

Dimensions

Product Dimension 2300 X 2300 X 880
Dry Weight 350kg
Weight with Water 2190kg

Features

Suction 5 pcs
Drainage Outlet 1 pc
Headrest pillows (pcs) 3 pcs
Support frame Aluminum (40mm X 20mm)
Skirt PS + Acrylic Corner
Shell insulation 2 cm
Base ABS

Electric components

Control system Gecko +3kW Heater
Power supply 220V/380V/110V
Underwater Lighting 1 pc

Jet Configuration

Total Jets 103 pcs
Hydrotherapy Jets 5" 1 pc
Hydrotherapy Jets 4" -
Hydrotherapy Jets 3" 3 pcs
Hydrotherapy Jets 2,5" -
Hydrotherapy Jets 2" 99 pcs
Hydrotherapy Jets 1" -

Filtration

Filter 1 pc, 1 X 50sf
OZON Sterilizer 1 pc



OX V04

DIMENSIONS: 2100 X 2100 X 880

Seating

2 lounges & 3 seats

Shell

Shell colours 7 colours options
Shell material Mitsubishi JP

Pumps

Circulation Pump 1 X 0,35hp
Jet Pump 2 x 3hp

Dimensions

Product Dimension 2100 X 2100 X 880
Dry Weight 340kg
Weight with Water 1850kg

Features

Suction 5 pcs
Drainage Outlet 1 pc
Headrest pillows (pcs) 3 pcs
Support frame Aluminum (40mm X 20mm)
Skirt PS + Acrylic corner
Shell insulation 2 cm
Base ABS

Electric components

Control system Gecko +3kW Heater
Power supply 220V/380V/110V
Underwater Lighting 1 pc

Jet Configuration

Total Jets 53 pcs
Hydrotherapy Jets 5" 5 pcs
Hydrotherapy Jets 4" -
Hydrotherapy Jets 3" 12 pcs
Hydrotherapy Jets 2,5" -
Hydrotherapy Jets 2" 36 pcs
Hydrotherapy Jets 1" -

Filtration

Filter Top mounted filter
OZON Sterilizer 1 pc



OX V05

DIMENSIONS: 2100 X 2100 X 880

Seating

1 lounge & 6 seats

Shell

Shell colours 7 colours options
Shell material Mitsubishi JP

Pumps

Circulation Pump 1 x 0,35hp
Jet Pump 2 x 3hp

Dimensions

Product Dimension 2100 X 2100 X 880
Dry Weight 340kg
Weight with Water 1850kg

Features

Suction 5 pcs
Drainage Outlet 1 pc
Headrest pillows (pcs) 4 pcs
Support frame Aluminum (40mm X 20mm)
Skirt PS + Acrylic corner
Shell insulation 2 cm
Base ABS

Control system Gecko +3kW Heater
Power supply 220V/380V/110V
Underwater Lighting 1 pc

Jet Configuration

Total Jets 51 pcs
Hydrotherapy Jets 5" 4 pcs
Hydrotherapy Jets 4" -
Hydrotherapy Jets 3" 9 pcs
Hydrotherapy Jets 2,5" -
Hydrotherapy Jets 2" 38 pcs
Hydrotherapy Jets 1" -

Filtration

Filter 1 pc, 1 X 50sf
OZON Sterilizer 1 pc



OX 801

DIMENSIONS: 2300 X 2300 X 880

| | |
|----------------------------|-------------------------------------|
| Seating | |
| 2 lounges & 3 seats | |
| Shell | |
| Shell colours | 7 colours options |
| Shell material | Mitsubishi JP |
| Pumps | |
| Circulation Pump | 1 x 0,35hp |
| Jet Pump | 1 x 3hp |
| Dimensions | |
| Product Dimension | 2300 X 2300 X 880 |
| Dry Weight | 410kg |
| Weight with Water | 2210kg |
| Features | |
| Suction | 4 pcs |
| Drainage Outlet | 1 pc |
| Headrest pillows (pcs) | 3 pcs |
| Support frame | Aluminum (40mm X 20mm) |
| Skirt | Aluminium panel(10mm) + Corner(3mm) |
| Shell insulation | 2 cm |
| Base | ABS with EVA |
| Electric components | |
| Control system | Gecko +3kW Heater |
| Power supply | 220V/380V/110V |
| Underwater Lighting | 1 pc |
| Jet Configuration | |
| Total Jets | 48 pcs |
| Hydrotherapy Jets 5" | - |
| Hydrotherapy Jets 4" | - |
| Hydrotherapy Jets 3" | 7 pcs |
| Hydrotherapy Jets 2,5" | 12 pcs |
| Hydrotherapy Jets 2" | 24 pcs |
| Hydrotherapy Jets 1" | - |
| Filtration | |
| Filter | 1 pc, 1 X 100sf |
| OZON Sterilizer | 1 pc |



OX 805

DIMENSIONS: 1950 X 1950 X 820

| | |
|----------------------------|-------------------------------------|
| Seating | |
| 2 Lounges & 3 seats | |
| Shell | |
| Shell colours | 7 colours options |
| Shell material | Mitsubishi JP |
| Pumps | |
| Circulation Pump | 1 X 0,35hp |
| Jet Pump | 1 x 3hp |
| Dimensions | |
| Product Dimension | 1950 X 1950 X 820 |
| Dry Weight | 300kg |
| Weight with Water | 1500kg |
| Features | |
| Suction | 2 pcs |
| Drainage Outlet | 1 pc |
| Headrest pillows (pcs) | 3 pcs |
| Support frame | Aluminum (40mm X 20mm) |
| Skirt | Aluminium panel(10mm) + Corner(3mm) |
| Shell insulation | 2 cm |
| Base | ABS with EVA |
| Electric components | |
| Control system | Gecko +3kW Heater |
| Power supply | 220V/380V/110V |
| Underwater Lighting | 1 pc |
| Jet Configuration | |
| Total Jets | 31 pcs |
| Hydrotherapy Jets 5" | - |
| Hydrotherapy Jets 4" | - |
| Hydrotherapy Jets 3" | 7 pcs |
| Hydrotherapy Jets 2,5" | 12 pcs |
| Hydrotherapy Jets 2" | 24 pcs |
| Hydrotherapy Jets 1" | - |
| Filtration | |
| Filter | 1 pc, 1 X 100sf |
| OZON Sterilizer | 1 pc |



OX 808

DIMENSIONS: 2000 X 2000 X 820

Seating

5 seats

Shell

Shell colours 7 colours options
Shell material Mitsubishi JP

Pumps

Circulation Pump 1 X 0,35hp
Jet Pump 1 x 3hp

Dimensions

Product Dimension 2000 X 2000 X 820
Dry Weight 300kg
Weight with Water 1600kg

Features

Suction 2 pcs
Drainage Outlet 1 pc
Headrest pillows (pcs) 3 pcs
Support frame Aluminum (40mm X 20mm)
Skirt Aluminium panel(10mm) + Corner(3mm)
Shell insulation 2 cm
Base ABS with EVA

Electric components

Control system Gecko +3kW Heater
Power supply 220V/380V/110V
Underwater Lighting 1 pc

Jet Configuration

Total Jets 30 pcs
Hydrotherapy Jets 5" 3 pcs
Hydrotherapy Jets 4" -
Hydrotherapy Jets 3" 4 pcs
Hydrotherapy Jets 2,5" 7 pcs
Hydrotherapy Jets 2" 13 pcs
Hydrotherapy Jets 1" 3 pcs

Filtration

Filter 1 pc, 1 x 100sf
OZON Sterilizer 1 pc



OX 810

DIMENSIONS: 2300 X 2300 X 880

Seating

1 lounge & 5 seats

Shell

Shell colours 7 colours options
Shell material Mitsubishi JP

Pumps

Circulation Pump 1 x 0,35hp
Jet Pump 2 x 3hp

Dimensions

Product Dimension 2300 X 2300 X 880
Dry Weight 410kg
Weight with Water 2210kg

Features

Suction 4 pcs
Drainage Outlet 1 pc
Headrest pillows (pcs) 4 pcs
Support frame Aluminum (40mm X 20mm)
Skirt Aluminium panel(10mm) + Corner(3mm)
Shell insulation 2 cm
Base ABS

Control system Gecko +3kW Heater
Power supply 220V/380V/110V

Underwater Lighting 1 pc

Jet Configuration

Total Jets 55 pcs
Hydrotherapy Jets 5" 4 pcs
Hydrotherapy Jets 4" -
Hydrotherapy Jets 3" 13 pcs
Hydrotherapy Jets 2,5" 13 pcs
Hydrotherapy Jets 2" 25 pcs
Hydrotherapy Jets 1" -

Filtration

Filter 2 pcs, 2 X 50sf
OZON Sterilizer 1 pc



OX L301

DIMENSIONS: 2200 X 1560 X 880

| | |
|----------------------------|------------------------------------|
| Seating | |
| 2 lounges & 1 seat | |
| Shell | |
| Shell colours | 7 colours options |
| Shell material | Mitsubishi JP |
| Pumps | |
| Circulation Pump | 1 x 0,35hp |
| Jet Pump | 2 x 3hp |
| Dimensions | |
| Product Dimension | 2200 X 1560 X 880 |
| Dry Weight | 300kg |
| Weight with Water | 1500kg |
| Features | |
| Suction | 3 pcs |
| Drainage Outlet | 1 pc |
| Headrest pillows (pcs) | 2 pcs |
| Support frame | Aluminum (40mm X 20mm) |
| Skirt | Aluminium panel(10mm) + ABS Corner |
| Shell insulation | 2 cm |
| Base | ABS with PVC |
| Electric components | |
| Control system | Gecko +3kW Heater |
| Power supply | 220V/380V/110V |
| Underwater Lighting | 1 pc |
| Jet Configuration | |
| Total Jets | 68 pcs |
| Hydrotherapy Jets 5" | 3 pcs |
| Hydrotherapy Jets 4" | - |
| Hydrotherapy Jets 3" | 9 pcs |
| Hydrotherapy Jets 2,5" | 30 pcs |
| Hydrotherapy Jets 2" | 18 pcs |
| Hydrotherapy Jets 1" | 8 pcs |
| Filtration | |
| Filter | 1 pc, 1 X 100sf |
| OZON Sterilizer | 1 pc |



OX L303

DIMENSIONS: 2000 X 1300 X 820

| | |
|----------------------------|------------------------------------|
| Seating | |
| 2 Lounges | |
| Shell | |
| Shell colours | 7 colours options |
| Shell material | Mitsubishi JP |
| Pumps | |
| Circulation Pump | |
| Jet Pump | 1 x 2,5hp (two speed) |
| Dimensions | |
| Product Dimension | 2000 X 1300 X 820 |
| Dry Weight | 230kg |
| Weight with Water | 1230kg |
| Features | |
| Suction | 1 pc |
| Drainage Outlet | 1 pc |
| Headrest pillows (pcs) | 2 pcs |
| Support frame | Aluminum (40mm X 20mm) |
| Skirt | Aluminium panel(10mm) + ABS Corner |
| Shell insulation | 2 cm |
| Base | Fiberglass |
| Electric components | |
| Control system | Gecko +3kW Heater |
| Power supply | 220V/380V/110V |
| Underwater Lighting | 1 pc |
| Jet Configuration | |
| Total Jets | 33 pcs |
| Hydrotherapy Jets 5" | 6 pcs |
| Hydrotherapy Jets 4" | - |
| Hydrotherapy Jets 3" | 6 pcs |
| Hydrotherapy Jets 2,5" | 21 pcs |
| Hydrotherapy Jets 2" | - |
| Hydrotherapy Jets 1" | - |
| Filtration | |
| Filter | 1 pc, 1 X 50sf |
| OZON Sterilizer | 1 pc |



OX L508

DIMENSIONS: 2300 X 2300 X 900

Seating

2 lounges & 3 seats

Shell

Shell colours 7 colours options
Shell material Mitsubishi JP

Pumps

Circulation Pump 1 X 0,35hp
Jet Pump 3 x 3hp

Dimensions

Product Dimension 2300 X 2300 X 900
Dry Weight 410kg
Weight with Water 2210kg

Features

Suction 6 pcs
Drainage Outlet 1 pc
Headrest pillows (pcs) 3 pcs
Support frame Aluminum (40mm X 20mm)
Skirt Aluminium panel(10mm) + ABS Corner
Shell insulation 2 cm
Base ABS with EVA

Electric components

Control system Gecko +3kW Heater
Power supply 220V/380V/110V
Underwater Lighting 1 pc

Jet Configuration

Total Jets 88 pcs
Hydrotherapy Jets 5" 6 pcs
Hydrotherapy Jets 4" -
Hydrotherapy Jets 3" 6 pcs
Hydrotherapy Jets 2,5" 26 pcs
Hydrotherapy Jets 2" 23 pcs
Hydrotherapy Jets 1" 27 pcs

Filtration

Filter 1 pc, 1 x 100sf
OZON Sterilizer 1 pc



OX L702

DIMENSIONS: 3800 X 2250 X 920

Seating

1 lounge & 5 seats

Shell

Shell colours 7 colours options
Shell material Mitsubishi JP

Pumps

Circulation Pump -
Jet Pump 1 x 2,5 hp (two speed)

Dimensions

Product Dimension 3800 X 2250 X 920
Dry Weight 650kg
Weight with Water 3650kg

Features

Suction 6 pcs
Drainage Outlet 1 pc
Headrest pillows (pcs) 4 pcs
Support frame Aluminum (40mm X 20mm)
Skirt Aluminium panel(10mm) + ABS Corner
Shell insulation 2 cm
Base ABS with EVA

Control system Gecko +3kW Heater
Power supply 220V/380V/110V

Underwater Lighting 1 pc

Jet Configuration

Total Jets 103 pcs
Hydrotherapy Jets 5" 8 pcs
Hydrotherapy Jets 4" -
Hydrotherapy Jets 3" 17 pcs
Hydrotherapy Jets 2,5" 33 pcs
Hydrotherapy Jets 2" 17 pcs
Hydrotherapy Jets 1" 28 pcs

Filtration

Filter 1 pc, 1 X 50sf
OZON Sterilizer 1 pc



OX 6801

DIMENSIONS: 3900 X 2280 X 1350

| | |
|----------------------------|-------------------|
| Seating | |
| 3 seats | |
| Shell | |
| Shell colours | 3 colours options |
| Shell material | Mitsubishi JP |
| Pumps | |
| Circulation Pump | 1 x 0,35hp |
| Jet Pump | 3 x 3hp |
| Dimensions | |
| Product Dimension | 2200 X 1560 X 880 |
| Dry Weight | 1050kg |
| Weight with Water | 5750kg |
| Features | |
| Suction | 6 pcs |
| Drainage Outlet | 1 pc |
| Headrest pillows (pcs) | 2 pcs |
| Support frame | Galvanized Steel |
| Skirt | PS |
| Shell insulation | 2 cm |
| Base | Fiberglass |
| Electric components | |
| Control system | Gecko +3kW Heater |
| Power supply | 220V/380V/110V |
| Underwater Lighting | 1 pc |
| Jet Configuration | |
| Total Jets | 47 pcs |
| Hydrotherapy Jets 5" | 3 pcs |
| Hydrotherapy Jets 4" | 4 pcs |
| Hydrotherapy Jets 3" | 2 pcs |
| Hydrotherapy Jets 2,5" | 22 pcs |
| Hydrotherapy Jets 2" | 8 pcs |
| Hydrotherapy Jets 1" | 8 pcs |
| Filtration | |
| Filter | 2 pcs, 2 X 100sf |
| OZON Sterilizer | 1 pc |



OX 6802

DIMENSIONS: 5000 X 2280 X 1350

| | |
|----------------------------|--------------------|
| Seating | |
| 3 seats | |
| Shell | |
| Shell colours | 3 colours options |
| Shell material | Mitsubishi JP |
| Pumps | |
| Circulation Pump | 1 x 0,35hp |
| Jet Pump | 1 x 3hp |
| Dimensions | |
| Product Dimension | 5000 X 2280 X 1350 |
| Dry Weight | 1360kg |
| Weight with Water | 7460kg |
| Features | |
| Suction | 6 pc |
| Drainage Outlet | 1 pc |
| Headrest pillows (pcs) | 2 pcs |
| Support frame | Galvanized steel |
| Skirt | PS |
| Shell insulation | 2 cm |
| Base | Fiberglass |
| Electric components | |
| Control system | Gecko +3kW Heater |
| Power supply | 220V/380V/110V |
| Underwater Lighting | 1 pc |
| Jet Configuration | |
| Total Jets | 45 pcs |
| Hydrotherapy Jets 5" | - |
| Hydrotherapy Jets 4" | - |
| Hydrotherapy Jets 3" | - |
| Hydrotherapy Jets 2,5" | - |
| Hydrotherapy Jets 2" | - |
| Hydrotherapy Jets 1" | - |
| Filtration | |
| Filter | 2 pcs, 2 X 100sf |
| OZON Sterilizer | 1 pc |



OX 6803

DIMENSIONS: 5800 X 2280 X 1620

Seating

3 seats

Shell

Shell colours 3 colours options
Shell material Mitsubishi JP

Pumps

Circulation Pump 1 X 0,35hp
Jet Pump 3 x 3hp

Dimensions

Product Dimension 5800 X 2280 X 1620
Dry Weight 1860kg
Weight with Water 10160kg

Features

Suction 6 pcs
Drainage Outlet 1 pc
Headrest pillows (pcs) 2 pcs
Support frame Galvanized steel
Skirt PS
Shell insulation 2 cm
Base Fiberglass

Electric components

Control system Gecko +3kW Heater
Power supply 220V/380V/110V
Underwater Lighting 1 pc

Jet Configuration

Total Jets 45 pcs
Hydrotherapy Jets 5" -
Hydrotherapy Jets 4" -
Hydrotherapy Jets 3" -
Hydrotherapy Jets 2,5" -
Hydrotherapy Jets 2" -
Hydrotherapy Jets 1" -

Filtration

Filter 2 pcs, 2 x 100sf
OZON Sterilizer 1 pc



OX 7801

DIMENSIONS: 5800 X 2200 X 1550

Seating

5 seats

Shell

Shell colours 7 colours options
Shell material Mitsubishi JP

Pumps

Circulation Pump 2 x 0,35hp
Jet Pump 4 x 3 hp

Dimensions

Product Dimension 5800 X 2200 X 1550
Dry Weight 1720kg
Weight with Water 9720kg

Features

Suction 8 pcs
Drainage Outlet 1 pc
Headrest pillows (pcs) 5 pcs
Support frame Galvanized steel
Skirt PS
Shell insulation 2 cm
Base Fiberglass

Control system Gecko +3kW Heater
Power supply 220V/380V/110V

Underwater Lighting 1 pc

Jet Configuration

Total Jets 61 pcs
Hydrotherapy Jets 5" -
Hydrotherapy Jets 4" -
Hydrotherapy Jets 3" -
Hydrotherapy Jets 2,5" -
Hydrotherapy Jets 2" -
Hydrotherapy Jets 1" -

Filtration

Filter 2 pcs
OZON Sterilizer 1 pc



OX 7807

DIMENSIONS: 5800 X 2240 X 1350

| | |
|----------------------------|----------------------|
| Seating | |
| 1 lounge & 3 seats | |
| Shell | |
| Shell colours | 3 colours options |
| Shell material | Mitsubishi JP |
| Pumps | |
| Circulation Pump | 2 x 0,35hp |
| Jet Pump | 5 x 3hp |
| Dimensions | |
| Product Dimension | 5800 X 2240 X 1350 |
| Dry Weight | 1530kg |
| Weight with Water | 8430kg |
| Features | |
| Suction | 10 pcs |
| Drainage Outlet | 1 pc |
| Headrest pillows (pcs) | 4 pcs |
| Support frame | Galvanized Steel |
| Skirt | PS |
| Shell insulation | 2 cm |
| Base | Fiberglass |
| Electric components | |
| Control system | Gecko +3kW Heater |
| Power supply | 220V/380V/110V |
| Underwater Lighting | 2 pcs |
| Jet Configuration | |
| Total Jets | 95 pcs + 3 swim jets |
| Hydrotherapy Jets 5" | 3 pcs |
| Hydrotherapy Jets 4" | 19 pcs |
| Hydrotherapy Jets 3" | 10 pcs |
| Hydrotherapy Jets 2,5" | 2 pcs |
| Hydrotherapy Jets 2" | 14 pcs |
| Hydrotherapy Jets 1" | 50 pcs |
| Filtration | |
| Filter | 2 pcs, 2 X 100sf |
| OZON Sterilizer | 1 pc |



OX 7809

DIMENSIONS: 5800 X 2280 X 1400

| | |
|----------------------------|--------------------|
| Seating | |
| 1 lounge & 3 seats | |
| Shell | |
| Shell colours | 3 colours options |
| Shell material | Mitsubishi JP |
| Pumps | |
| Circulation Pump | 1 x 1hp |
| Jet Pump | 3 x 3hp |
| Dimensions | |
| Product Dimension | 5800 X 2280 X 1400 |
| Dry Weight | 1680kg |
| Weight with Water | 7800kg |
| Features | |
| Suction | 6 pc |
| Drainage Outlet | 1 pc |
| Headrest pillows (pcs) | 5 pcs |
| Support frame | Galvanized steel |
| Skirt | PS |
| Shell insulation | 2 cm |
| Base | Fiberglass |
| Electric components | |
| Control system | Gecko +3kW Heater |
| Power supply | 220V/380V/110V |
| Underwater Lighting | 1 pc |
| Jet Configuration | |
| Total Jets | 71 pcs |
| Hydrotherapy Jets 5" | - |
| Hydrotherapy Jets 4" | - |
| Hydrotherapy Jets 3" | - |
| Hydrotherapy Jets 2,5" | - |
| Hydrotherapy Jets 2" | - |
| Hydrotherapy Jets 1" | - |
| Filtration | |
| Filter | 1 pc |
| OZON Sterilizer | 1 pc |



OX 7860

DIMENSIONS: 5800 X 2280 X 1450

Seating

1 lounge & 4 seats

Shell

Shell colours 3 colours options
Shell material Mitsubishi JP

Pumps

Circulation Pump 2 X 1hp
Jet Pump 4 x 3hp

Dimensions

Product Dimension 5800 X 2280 X 1450
Dry Weight 1720kg
Weight with Water 9720kg

Features

Suction 6 pcs
Drainage Outlet 2 pc
Headrest pillows (pcs) 3 pcs
Support frame Galvanized steel
Skirt PS
Shell insulation 2 cm
Base Fiberglass

Electric components

Control system Gecko +3kW Heater
Power supply 220V/380V/110V
Underwater Lighting 1 pc

Jet Configuration

Total Jets 55 pcs + 3 swim jets
Hydrotherapy Jets 5" -
Hydrotherapy Jets 4" -
Hydrotherapy Jets 3" -
Hydrotherapy Jets 2,5" -
Hydrotherapy Jets 2" -
Hydrotherapy Jets 1" -

Filtration

Filter 3 pcs
OZON Sterilizer 1 pc

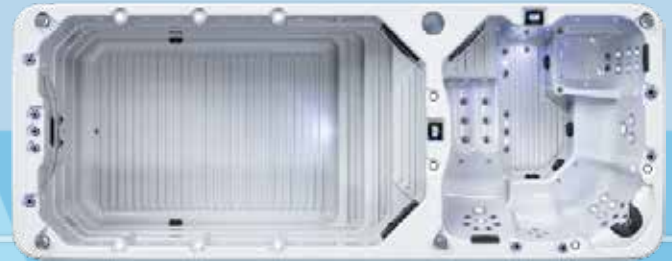

OX 7861

DIMENSIONS: 4500 X 2280 X 1400

Seating

3 seats

Shell

Shell colours 7 colours options
Shell material Mitsubishi JP

Pumps

Circulation Pump 1 x 1hp
Jet Pump 2 x 3 hp

Dimensions

Product Dimension 4500 X 2280 X 1400
Dry Weight 1200kg
Weight with Water 5900kg

Features

Suction 2 pcs
Drainage Outlet 1 pc
Headrest pillows (pcs) -
Support frame Galvanized steel
Skirt PS
Shell insulation 2 cm
Base Fiberglass

Control system Gecko +3kW Heater
Power supply 220V/380V/110V
Underwater Lighting 1 pc

Jet Configuration

Total Jets 5 pcs + 3 swim jets
Hydrotherapy Jets 5" 5 pcs
Hydrotherapy Jets 4" -
Hydrotherapy Jets 3" -
Hydrotherapy Jets 2,5" -
Hydrotherapy Jets 2" -
Hydrotherapy Jets 1" -

Filtration

Filter 2 pcs
OZON Sterilizer 1 pc



GECKO® controllers for SPA Y Series Spa Controls



- Each pack supports keypad, heater, a light, and configurable relays (3, 5 or 7, depending on model)
- Solid-state water flow detection: No pressure switch to adjust
- IPX5 rated waterproof design
- Preloaded configuration allows fast and easy installation
- in.touch wireless remote module compatible
- Connector: AMP and Quick Connect
- Supports 1, 2 and 3 phase input power (1 or 2 phases on in.yj)
- Standard 3 kW, 2" x 15" flow thru heater (minimum of 75 l/min required) • Temperature probe is built into the heater to simplify installation
- Freeze and overheat protections
- Self-Diagnostic
- Programmable filter cycles
- Corrosion-free enclosure

| CODE | MODEL | DIMENSION | OUTPUTS | LIGHTS | HEATING | PRICE |
|-----------|---------|----------------|---------|--------|---------|--------------|
| 761.00.77 | in.ye-3 | 307 X 187 X 95 | 3 | √ | 3Kw | 3,940.00 € |
| 761.00.78 | in.ye-5 | 307 X 187 X 95 | 5 | √ | 3Kw | Upon Request |
| 761.00.79 | in.yt-7 | 307 X 187 X 95 | 7 | √ | 4Kw | Upon Request |

X Series Spa Controls



- IPX5 waterproof rated
- Versatile pack that can support up to:
- in.xm2: 5 pumps, blower, circ pump, ozone & stereo outlet
- in.xe: 2 pumps, blower, Ozone or circ pump & stereo outlet
- Preloaded configurations allow fast and easy installation
- Large terminal block for easier electrical installation
- Supports 1, 2 and 3 phase input power (in.xe is 1 or 2 phase only)
- Standard 3 kW, 2" x 15" flow thru heater (minimum of 75 l/min required) • Programmable filter cycles
- Self-diagnostic
- Solid state dry-fire protection
- Kinetic heat, freeze and overheat protections
- Supports high-end & auxiliary topsides

| CODE | MODEL | DIMENSION | OUTPUTS | LIGHTS | HEATING | PRICE |
|-----------|--------|-----------------|---------|--------|---------|--------------|
| 104.20.15 | in.xe | 490 X 298 X 136 | 3 | √ | 3Kw | 3990,00 € |
| 104.20.16 | in.xm2 | 451 X 253 X 101 | 5 | √ | - | Upon Request |

GECKO® in.touch 2

Ultimate mobile remote control for your spa



- Push notifications to alert consumers even when the app is not open
- Extended communication range: 3 times longer than standard Wi-Fi signal
- Simple plug & play network through your ethernet connection
- Intuitive app layout
- Control pumps, blower and light
- Control water temperature set point
- Water care settings to save energy
- Retail ready packaging
- Compatible spa controllers:
- X and Y series versions 2012 and later

Compatible spa controllers:
X and Y series versions 2012 and later

Compatible devices:
For iOS and Android smartphones and tablets

| CODE | DESCRIPTION | PRICE |
|-----------|-------------|---------|
| 400.02.15 | in.touch 2 | 456.47€ |

GECKO® Keypads



| | |
|-----------------|--|
| CODE | 400.02.00 |
| MODEL | IN.K1000-BLACK-GE1 |
| INCLUDES | color keypad with touch screen |
| DIMENSIONS | 19 x 13 cm |
| CORD LENGTH | 3 m |
| COMPATIBLE WITH | in.xe and Y Series systems |
| INSTALLATION | MUST be installed on the OUTSIDE edge of the hot tub |
| PRICE | Upon Request |



| | |
|-----------------|--|
| CODE | 400.02.01 |
| MODEL | IN.K1001-CLEAR-GE1 |
| INCLUDES | color keypad with touch screen |
| DIMENSIONS | 15.4 x 9.8 cm |
| CORD LENGTH | 3 m |
| COMPATIBLE WITH | Y and X Series systems |
| INSTALLATION | MUST be installed on the OUTSIDE edge of the hot tub |
| PRICE | 975,90 € |



| | |
|-----------------|--|
| CODE | 400.02.02 |
| MODEL | IN.K800-CLEAR AND OVERLAY GE1 |
| INCLUDES | color keypad and overlay |
| CONFIGURATION | 10 buttons: Settings/Mode/P1/P2/P3/AUX1/AUX2/ Light/Up/Down |
| DIMENSIONS | 15.4 x 9.8 cm |
| CORD LENGTH | 3 m |
| COMPATIBLE WITH | Y and X Series systems |
| INSTALLATION | MUST be installed on the OUTSIDE edge of the hot tub |
| PRICE | 786.15€ |



| | |
|-----------------|--|
| CODE | 400.02.03 |
| MODEL | IN.K500-CLEAR AND OVERLAY GE1 |
| INCLUDES | color keypad and overlay |
| CONFIGURATION | 7 buttons: Settings/Light/Mode/Pump 1/Pump 2/Up/ Down |
| DIMENSIONS | 18.2 x 8.5 cm |
| CORD LENGTH | 3 m |
| COMPATIBLE WITH | Y and X Series systems |
| INSTALLATION | MUST be installed on the OUTSIDE edge of the hot tub |
| PRICE | 867.59€ |



| | |
|-----------------|---|
| CODE | 400.02.08 |
| MODEL | IN.K300 AND OVERLAY |
| INCLUDES | keypad, overlay |
| CONFIGURATION | 4 buttons: Pump 1/Light/Up/Down or 4 buttons: Pump 1/Pump 2/Light/Up-Down |
| DIMENSIONS | 15.9 x 7.5 cm |
| CORD LENGTH | 3 m |
| COMPATIBLE WITH | Y Series systems |
| PRICE | 746.17€ |

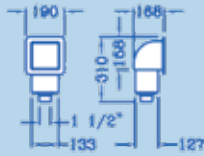

Spa Skimmer

| CODE | DESCRIPTION | MATERIAL | PRICE |
|-----------|---|-----------|---------|
| 104.24.67 | Spa skimmer 1 1/2" female thread outlet | White ABS | 188.42€ |

Spa Pneumatic Switch



| CODE | DESCRIPTION | MATERIAL | PRICE |
|-----------|-----------------------------------|------------|--------|
| 104.14.01 | Air button 3mm OD tube connection | White ABS | 32.80€ |
| 104.14.02 | Air button 3mm OD tube connection | Chrome ABS | 41.09€ |

Spa Air Regulator



| CODE | DESCRIPTION | MATERIAL | PRICE |
|-----------|-------------------------------|------------|--------|
| 104.10.00 | Air control 20mm ID x 3/4" OD | White ABS | 21.39€ |
| 104.10.04 | Air control 20mm ID x 3/4" OD | Chrome ABS | 39.01€ |
| 104.10.09 | Air control 32mm ID x 5/4" OD | White ABS | 28.29€ |

Spa Airjets



| CODE | DESCRIPTION | MATERIAL | PRICE |
|-----------|--|-----------|--------|
| 104.07.90 | Air jet to insert in D32 PN10 PVC pipe | White ABS | 27.27€ |

104.07.51

104.07.54



Double Energy Jets Body

| CODE | DESCRIPTION | MATERIAL | PRICE |
|-----------|--|-----------|--------|
| 104.07.51 | Jet body 50mm D water x 50mm D air | White ABS | 53.15€ |
| 104.07.54 | Escutcheon with eyeball, thread 2" OD. shaft length 30mm | White ABS | 14.49€ |

Spa Electric Switch



| CODE | DESCRIPTION | MATERIAL | PRICE |
|-----------|---|---------------------|---------|
| 104.14.06 | 1 x on/off function touch, cable length 2m, Max 12V, IP67 | Touch pad White ABS | 128.98€ |
| 104.14.07 | 2 x on/off function touch, cable length 2m, Max 12V, IP67 | Touch pad White ABS | 261.91€ |
| 104.14.08 | 3 x on/off function touch, cable length 2m, Max 12V, IP67 | Touch pad White ABS | 292.99€ |

Spa Blower - Heater/Blower



- Large wind, low noise and without obvious noise from high frequency
- Heater quick-dry function
- Thermal protector of TP16050(Dezhou Equipment)
- There is fuse inside the motor
- Insulation class F
- Recognize certified: CE

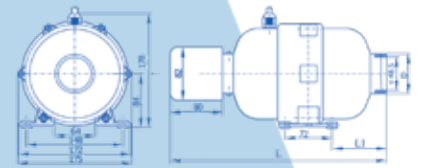

| CODE | DESCRIPTION | POWER (W) | NUMBER OF NOZZLES | OUTLET | PRICE |
|-----------|-----------------------------|-----------|-------------------|---------------|---------|
| 104.15.01 | AIR BLOWER 220V/50Hz | 630-700 | 16-32 | Φ63 or 1 1/2" | 493.45€ |
| 104.15.02 | AIR BLOWER 220V/50Hz | 820-900 | 20-40 | Φ63 or 1 1/2" | 548.66€ |
| 104.15.03 | HEATER/AIR BLOWER 220V/50Hz | 630-700 | 16-32 | Φ63 or 1 1/2" | 583.18€ |
| 104.15.04 | HEATER/AIR BLOWER 220V/50Hz | 820-900 | 20-40 | Φ63 or 1 1/2" | 672.90€ |

Spa Air Generator



| CODE | DESCRIPTION | kW | PRICE |
|-----------|-------------------|--------|-----------|
| 104.15.05 | Spa Air Generator | 1,1 kw | 1450,00 € |
| 104.15.06 | Spa Air Generator | 1,5 kw | 1740,00 € |
| 104.15.07 | Spa Air Generator | 2,2 kw | 2450,00 € |

San Marino

2,95m X 6,00m X 1,5m



Oxygon introduces fiberglass gel-coated swimming pools manufactured by a German company, combining our 25 years of proven expertise in pool equipment with German precision and strict production quality control. The pools are produced as a single monobloc structure from polyester resins reinforced with fiberglass, using advanced technologies and equipped with an integrated interior staircase. Reinforced with high-density polyurethane inserted into the structure, they provide superior mechanical strength, enhanced thermal insulation, and eliminate the risk of osmotic blistering — delivering durability, efficiency, and long-term performance in one complete operational kit.



The **San Marino** model (2.95 x 6.00 m, depth 1.50 m) is the ideal solution for compact spaces, boutique developments, or hotel rooms with private pools. Its balanced dimensions offer a comfortable swimming area while maintaining a minimal footprint, making it perfect for modern architectural projects that require premium quality in limited space. Elegant, durable, and easy to install, San Marino combines refined aesthetics with long-term structural reliability.

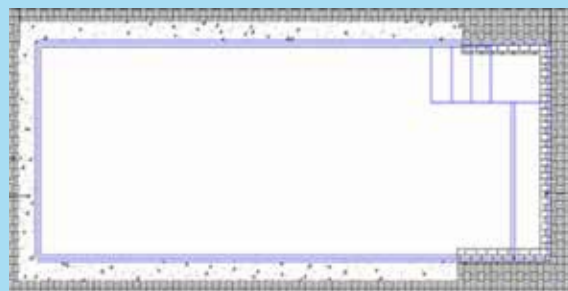

| CODE | MODEL | DIMESNION | PRICE |
|------------|------------|----------------------|-------------|
| 801.10.201 | San Marino | 2,96m X 6,00m X 1,5m | 23.226,00 € |

Roma

3,60m X 7,50m X 1,5m
3,60m X 9,70m X 1,5m



Oxygon expands its range with premium fiberglass gel-coated swimming pools manufactured by a German company, uniting German engineering standards with our 25 years of experience in pool systems and equipment. Each pool is built as a monobloc structure from fiberglass-reinforced polyester resins under strict quality control and advanced production technologies, featuring an integrated interior staircase. The structure is reinforced with high-density polyurethane, increasing mechanical strength, improving thermal insulation, and eliminating the risk of osmotic blistering — ensuring durability, energy efficiency, and reliable long-term performance as a complete operational solution.



Inspired by the classic Roman-end pool design, the **Roma** model combines timeless elegance with modern structural performance. Available in two sizes — 3.60 x 7.50 m and 3.60 x 9.70 m, both with a depth of 1.50 m — it offers generous swimming space and refined architectural lines. Ideal for residential villas and premium hospitality projects, Roma delivers aesthetic sophistication, structural strength, and efficient installation in a durable monobloc fiberglass construction.



| CODE | MODEL | DIMESNION | PRICE |
|------------|----------|----------------------|-------------|
| 801.10.202 | Roma 750 | 3,60m X 7,50m X 1,5m | 31.164,00 € |
| 801.10.203 | Roma 970 | 3,60m X 9,70m X 1,5m | 35.490,00 € |

Roma Maxima

3,60m X 8,00m X 1,5m
3,60m X 10,20m X 1,5m



Building on 25 years of expertise in pool technology, Oxygon offers premium fiberglass gel-coated swimming pools manufactured by a German company and produced according to the highest European quality standards. Each pool is crafted as a one-piece monobloc structure from fiberglass-reinforced polyester resins under strict quality control, featuring an integrated interior staircase. Reinforced with high-density polyurethane embedded within the structure, the pools achieve increased mechanical strength, improved thermal insulation, and elimination of osmotic blistering risk — ensuring durability, efficiency, and long-term structural reliability as a complete operational solution.



Roma Maxima is the larger evolution of the classic Roma design, created for projects that demand expanded swimming space and architectural presence. Available in two generous dimensions — 3.60 x 8.00 m and 3.60 x 10.20 m, both with a depth of 1.50 m — it maintains the elegant Roman-end styling while offering enhanced comfort and functionality. Ideal for spacious private residences and premium hospitality environments, Roma Maxima combines refined aesthetics with robust monobloc fiberglass construction and long-term performance.

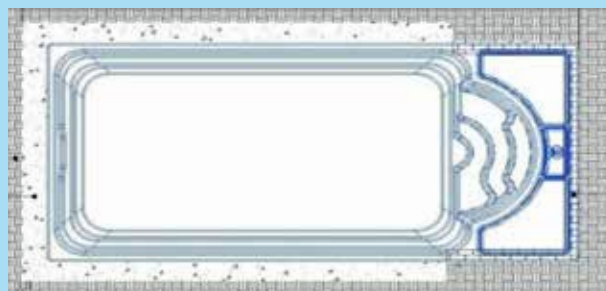

| CODE | MODEL | DIMENSION | PRICE |
|------------|------------------|-----------------------|-------------|
| 801.10.204 | Roma Maxima 800 | 3,60m X 8,00m X 1,5m | 31.752,00 € |
| 801.10.205 | Roma Maxima 1020 | 3,60m X 10,20m X 1,5m | 37.212,00 € |

Stefanie

3,60m X 8,00m X 1,5m
3,60m X 10,00m X 1,5m



Oxygon enhances its portfolio with high-quality fiberglass gel-coated swimming pools manufactured by a German company, reflecting a perfect balance between German engineering precision and our 25 years of expertise in pool systems and equipment. Produced as a single monobloc unit from fiberglass-reinforced polyester resins under rigorous quality standards, each pool includes an integrated interior staircase for optimal functionality and design coherence. The structure is reinforced with high-density polyurethane incorporated into the shell, increasing mechanical durability, improving thermal insulation, and eliminating the risk of osmotic blistering — ensuring long-term performance, structural integrity, and energy efficiency as a complete operational package.



Inspired by the elegance and refinement of a famous princess, the **Stephanie** model combines graceful design with modern performance. Available in two dimensions — 3.60 x 8.00 m and 3.60 x 10.00 m, both with a depth of 1.50 m — it offers generous swimming space while preserving harmonious proportions. Ideal for refined residential projects and upscale hospitality environments, Stephanie blends timeless aesthetics with durable monobloc fiberglass construction and long-term structural reliability.

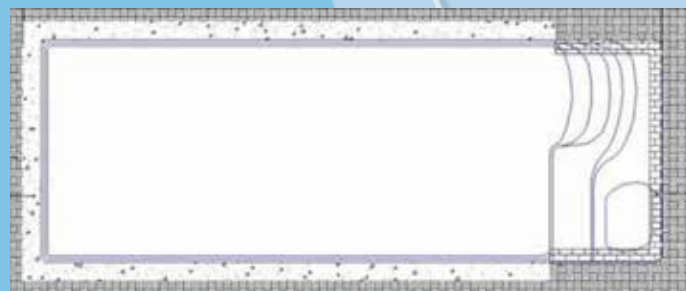

| CODE | MODEL | DIMESNION | PRICE |
|------------|---------------|-----------------------|-------------|
| 801.10.206 | Stefanie 800 | 3,60m X 8,00m X 1,5m | 31.752,00 € |
| 801.10.207 | Stefanie 1000 | 3,60m X 10,00m X 1,5m | 36.540,00 € |

Elite Open View



- Indoor sauna
- Capacity 6 people
- Cabin made of solid 4cm fir wood
- 10.5kW, 380V, stainless steel heater
- Two tiered benches
- Wooden footstool
- 8mm safety glass
- Stainless steel screws and connectors
- Sauna lights
- Sauna stones
- Sauna accessories (wooden bucket, wooden spoon, hour-glass, hygrometer/thermometer)
- Handcrafted
- Easy two-person assembly.

| CODE | MODEL | DIMENSION W x D x H | PRICE |
|-----------|-----------------|---------------------|------------|
| 401.02.03 | Elite Open View | 200 X 200 X 205 | 12,509.18€ |

Element

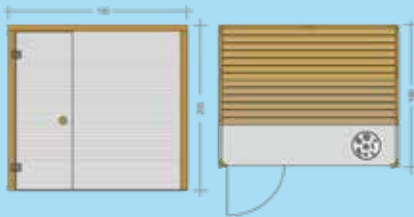

- Indoor sauna
- Capacity 6 people
- Cabin made of solid 4cm fir wood
- 9kW, 220V/380V, stainless steel heater
- Two tiered benches
- Wooden footstool
- 8mm safety glass
- Stainless steel screws and connectors
- Sauna lights
- Sauna stones
- Sauna accessories (wooden bucket, wooden spoon, hour-glass, hygrometer/thermometer)
- Handcrafted
- Easy two-person assembly.

| CODE | MODEL | DIMENSION W x D x H | PRICE |
|-----------|---------|---------------------|------------|
| 401.02.05 | Element | 190 X 160 X 205 | 10,256.06€ |

Elite Total Wood

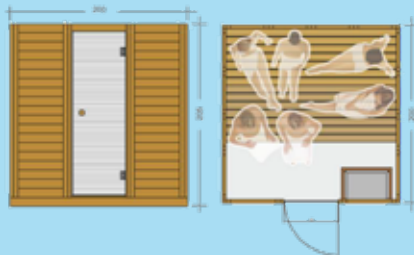

- Indoor sauna
- Capacity 6 people
- Cabin made of solid 4cm fir wood
- 9kW, 220V/380V, stainless steel heater
- Two tiered benches
- Wooden footstool
- 8mm safety glass
- Stainless steel screws and connectors
- Sauna lights
- Sauna stones
- Sauna accessories (wooden bucket, wooden spoon, hour-glass, hygrometer/thermometer)
- Handcrafted
- Easy two-person assembly.

| CODE | MODEL | DIMENSION W x D x H | PRICE |
|-----------|------------------|---------------------|------------|
| 401.02.07 | Elite Total Wood | 200X 200 X 205 | 10,455.62€ |

Elite Home



- Indoor sauna
- Capacity 6 people
- Cabin made of solid 4cm fir wood
- 9kW, 220V/380V, stainless steel heater
- Two tiered benches
- Wooden footstool
- 8mm safety glass
- Stainless steel screws and connectors
- Sauna lights
- Sauna stones
- Sauna accessories (wooden bucket, wooden spoon, hour-glass, hygrometer/thermometer)
- Handcrafted
- Easy two-person assembly.

| CODE | MODEL | DIMENSION W x D x H | PRICE |
|-----------|------------|---------------------|------------|
| 401.02.09 | Elite Home | 200X 200 X 205 | 10,455.62€ |

Harmony



- Indoor sauna
- Capacity 4 people
- Cabin made of solid 4cm fir wood
- 8kW, 220V/380V, stainless steel heater
- Two tiered benches
- Wooden footstool
- 8mm safety glass
- Stainless steel screws and connectors
- Sauna lights
- Sauna stones
- Sauna accessories (wooden bucket, wooden spoon, hour-glass, hygrometer/thermometer)
- Handcrafted
- Easy two-person assembly.

| CODE | MODEL | DIMENSION W x D x H | PRICE |
|-----------|---------|---------------------|-----------|
| 401.02.12 | Hamrony | 160X 150 X 205 | 9,361.25€ |

Charisma

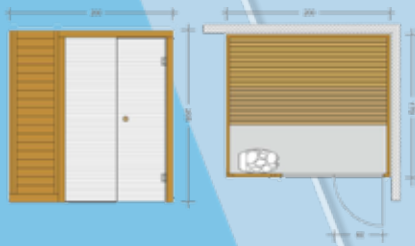

- Indoor sauna
- Capacity 6 people
- Cabin made of solid 4cm fir wood
- 9kW, 220V/380V, stainless steel heater
- Two tiered benches
- Wooden footstool
- 8mm safety glass
- Stainless steel screws and connectors
- Sauna lights
- Sauna stones
- Sauna accessories (wooden bucket, wooden spoon, hour-glass, hygrometer/thermometer)
- Handcrafted
- Easy two-person assembly.

| CODE | MODEL | DIMENSION W x D x H | PRICE |
|-----------|----------|---------------------|-----------|
| 401.02.14 | Charisma | 200X 170 X 205 | 9,361.25€ |

Balance

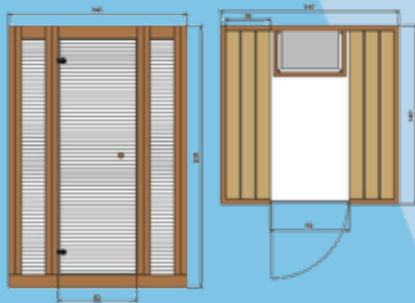

- Indoor sauna
- Capacity 2-4 people
- Cabin made of solid 4cm fir wood
- 6kW, 220V/380V, stainless steel heater
- Two tiered benches
- Wooden footstool
- 8mm safety glass
- Stainless steel screws and connectors
- Sauna lights
- Sauna stones
- Sauna accessories (wooden bucket, wooden spoon, hour-glass, hygrometer/thermometer)
- Handcrafted
- Easy two-person assembly.

| CODE | MODEL | DIMENSION W x D x H | PRICE |
|-----------|---------|---------------------|-----------|
| 401.02.24 | Balance | 140 X 140 X 205 | 8,351.50€ |

Smart



- Indoor sauna
- Capacity 2 people
- Cabin made of solid 4cm fir wood
- 4,5kW, 220V/380V, stainless steel heater
- Two tiered benches
- Wooden footstool
- 8mm safety glass
- Stainless steel screws and connectors
- Sauna lights
- Sauna stones
- Sauna accessories (wooden bucket, wooden spoon, hour-glass, hygrometer/thermometer)
- Handcrafted
- Easy two-person assembly.

| CODE | MODEL | DIMENSION W x D x H | PRICE |
|-----------|-------|---------------------|-----------|
| 401.02.26 | Smart | 120 X 120 X 205 | 6,888.12€ |



Prestige

- Indoor sauna
- Capacity 2-4 people
- Cabin made of solid 4cm fir wood
- Internal oak lining
- 4kW, 220V/380V, stainless steel heater
- Two tiered benches
- Wooden footstool
- 8mm safety glass
- Stainless steel screws and connectors
- Sauna lights
- Sauna stones
- Sauna accessories (wooden bucket, wooden spoon, hour-glass, hygrometer/thermometer)
- Handcrafted
- Easy two-person assembly.

| CODE | MODEL | DIMENSION W x D x H | PRICE |
|-----------|-----------------------|---------------------|-----------|
| 401.02.28 | Prestige | 170 X 150 X 205 | 9,490.00€ |
| 401.02.42 | Exterior Oak paneling | | 5,885.00€ |
| 401.02.43 | LED Lighting | | 897.50€ |

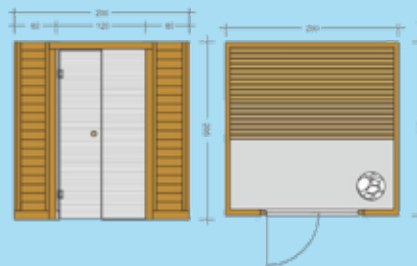

Aurora

- Indoor sauna
- Capacity 6 people
- Cabin made of cedar wood with insulation
- Outer lining of cedar (optional)
- 9kW, 220V/380V, stainless steel heater
- Two tiered benches
- Wooden footstool
- 8mm safety glass
- Stainless steel screws and connectors
- Sauna lights
- Sauna stones
- Sauna accessories (wooden bucket, wooden spoon, hour-glass, hygrometer/thermometer)
- Handcrafted
- Easy two-person assembly.

| CODE | MODEL | DIMENSION W x D x H | PRICE |
|-----------|--------|---------------------|--------------|
| 401.02.30 | Aurora | 200 X 200 X 205 | Upon Request |

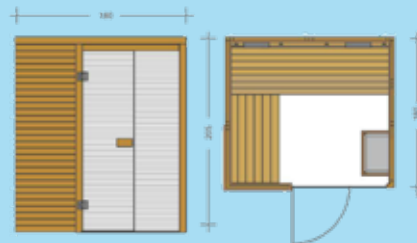

Cedar

- Indoor sauna
- Capacity 4 people
- Cabin made of cedar wood with insulation
- Outer lining of cedar (optional)
- 8kW, 220V/380V, stainless steel heater
- Two tiered benches
- Wooden footstool
- 8mm safety glass
- Stainless steel screws and connectors
- Sauna lights
- Sauna stones
- Sauna accessories (wooden bucket, wooden spoon, hour-glass, hygrometer/thermometer)
- Handcrafted
- Easy two-person assembly.

| CODE | MODEL | DIMENSION W x D x H | PRICE |
|-----------|-------|---------------------|------------|
| 401.02.32 | Cedar | 180 X 160 X 205 | 21,168.75€ |

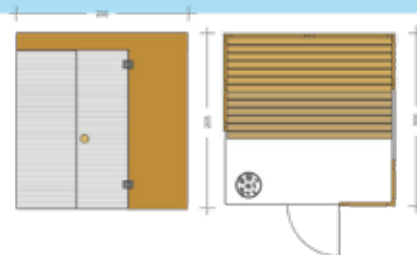

Rustic Chic

- Indoor sauna
- Capacity 6 people
- Cabin made of Hemlock
- External Rustic oak lining (optionally)
- 10kW, 380V, Cilindro stainless steel heater
- Two tiered benches
- Wooden footstool
- 8mm safety glass
- Stainless steel screws and connectors
- Sauna lights
- Sauna stones
- Sauna accessories (wooden bucket, wooden spoon, hour-glass, hygrometer/thermometer)
- Handcrafted
- Easy two-person assembly.

| CODE | MODEL | DIMENSION W x D x H | PRICE |
|-----------|-------------|---------------------|------------|
| 401.02.34 | Rustic Chic | 180 X 160 X 205 | 19,570.00€ |

Vareli Panorama

- Cabin made of solid 4cm fir wood
 - Two tiered benches
 - Wooden footstool
 - 8mm safety glass
- Stainless steel screws and connectors
 - Sauna lights
 - Sauna stones
- Sauna accessories (wooden bucket, wooden spoon, hourglass, hygrometer/thermometer)
 - Handcrafted
- Easy two-person assembly.

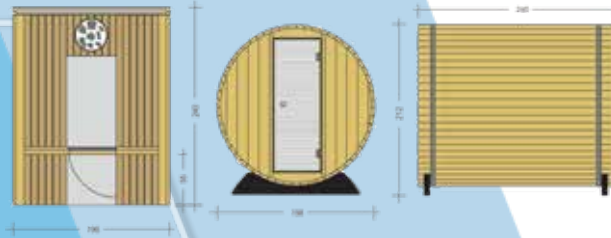

| CODE | MODEL | DIMENSION W x D x H | PRICE |
|-----------|-----------------|---------------------|------------|
| 401.02.36 | Vareli Panorama | 198 X 240 X 212 | 12,193.75€ |

Vareli Small

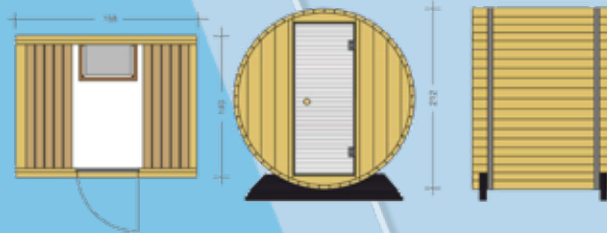

| CODE | MODEL | DIMENSION W x D x H | PRICE |
|-----------|--------------------------------|---------------------|-----------|
| 401.02.38 | Vareli Small Capacity 4 people | 198 X 140 X 212 | 9,361.25€ |

Vareli Large

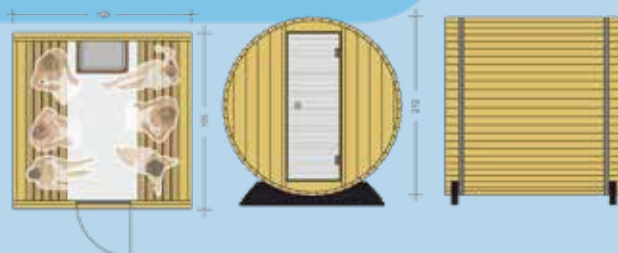

| CODE | MODEL | DIMENSION W x D x H | PRICE |
|-----------|--------------------------------|---------------------|-----------|
| 401.02.40 | Vareli Large Capacity 6 people | 198 X 195 X 212 | 9,490.00€ |



Jens Series Sauna Heater

The JENS heater is based on traditional technology. This heater is ideal for saunas of all shapes, and can even be placed in the middle of a sauna. Stately in appearance, JENS heaters are suitable for saunas sized from 8-15 m³. Available in Stainless Steel. Recommended amount of rocks 60kg.

| CODE | MODEL | kW | SAUNA SIZE M ³ | ROCK CAPACITY | CONTROL PANEL | PRICE |
|-----------|-----------|------|------------------------------|---------------|------------------|-----------|
| 203.11.10 | JENS 900 | 9,0 | 8-13 | 60kg | Separate control | 1,055.75€ |
| 203.11.12 | JENS 1050 | 10,5 | 9-15 | 60kg | Separate control | 1,256.88€ |

Sauna Wooden Set



Sauna Copper Set



| CODE | MODEL | PRICE |
|------------|------------------|---------|
| 203.11.205 | Sauna Wooden Set | 200.85€ |
| 203.11.206 | Sauna Copper Set | 319.30€ |

Oxygon Ephesus Series Steam Generators



STEAM GENERATOR SELECTION METHOD

| Room Volume (m ³) x K1 x K2 = Required power (kW) | |
|--|---------|
| CONSTANT | K |
| Ventilated Room | K1=0,75 |
| Non Ventilated Room | K1=0,52 |
| Acrylic Room | K2=2 |
| Board & Tiles | K2=1,25 |
| Concrete & Tiles | K2=1 |

Features:

- Energy saving by 2-step temperature controlling - when set temperature (max. 50°C) is reached, 2 of the heating elements turn off and 1 heating element up keeps the temperature until the temperature drops with 1°C. Then remaining 2 heating elements turn on and quickly adjust the temperature.
- Easy tank cleaning through direct access to the descale fill tube located on the top of the steam generator.
- Multivoltage 230V 1N~, 230V 3~, 400V 3N~. Also available as 240V 1N~ / 2~, / 415V 3N~.

| CODE | STEAM PRODUCTION Kg/h | POWER kW | PRICE |
|------------|--------------------------|-------------|-----------|
| 203.11.211 | 12 | 9,0 | 4,539.80€ |
| 203.11.212 | 16 | 12 | 4,732.29€ |
| 203.11.213 | 19 | 15 | 4,908.87€ |
| 203.11.214 | Controller M2 | All models | 1,398.87€ |



OXYGON⁺

PNC Parts / Pipinog



90° Elbow

| CODE | DESCRIPTION | PRICE |
|-----------|---------------------|--------|
| 107.03.21 | Elbow 90° Ø25 PN16 | 0.88€ |
| 107.03.22 | Elbow 90° Ø32 PN16 | 1.40€ |
| 107.03.23 | Elbow 90° Ø40 PN16 | 1.73€ |
| 107.03.24 | Elbow 90° Ø50 PN16 | 2.01€ |
| 107.03.25 | Elbow 90° Ø63 PN16 | 2.76€ |
| 107.03.26 | Elbow 90° Ø75 PN16 | 5.05€ |
| 107.03.27 | Elbow 90° Ø90 PN16 | 6.90€ |
| 107.03.28 | Elbow 90° Ø110 PN16 | 16.91€ |
| 107.03.29 | Elbow 90° Ø125 PN16 | 20.39€ |
| 107.03.30 | Elbow 90° Ø140 PN16 | 56.65€ |
| 107.03.31 | Elbow 90° Ø160 PN16 | 59.44€ |



45° Elbow

| CODE | DESCRIPTION | PRICE |
|-----------|---------------------|--------|
| 107.03.08 | Elbow 45° Ø32 PN16 | 2.37€ |
| 107.03.09 | Elbow 45° Ø40 PN16 | 2.44€ |
| 107.03.10 | Elbow 45° Ø50 PN16 | 2.47€ |
| 107.03.11 | Elbow 45° Ø63 PN16 | 2.82€ |
| 107.03.12 | Elbow 45° Ø75 PN16 | 7.05€ |
| 107.03.13 | Elbow 45° Ø90 PN16 | 8.79€ |
| 107.03.14 | Elbow 45° Ø110 PN16 | 11.61€ |
| 107.03.15 | Elbow 45° Ø125 PN16 | 40.26€ |
| 107.03.16 | Elbow 45° Ø140 PN16 | 53.30€ |
| 107.03.17 | Elbow 45° Ø160 PN16 | 61.20€ |

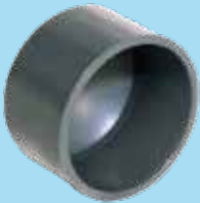

End Cup

| CODE | DESCRIPTION | PRICE |
|-----------|-------------------|--------|
| 107.10.11 | End Cap Ø25 PN16 | 1.12€ |
| 107.10.12 | End Cap Ø32 PN16 | 1.12€ |
| 107.10.14 | End Cap Ø50 PN16 | 1.59€ |
| 107.10.15 | End Cap Ø63 PN16 | 1.70€ |
| 107.10.16 | End Cap Ø75 PN16 | 3.43€ |
| 107.10.17 | End Cap Ø90 PN16 | 5.29€ |
| 107.10.18 | End Cap Ø110 PN16 | 8.79€ |
| 107.10.19 | End Cap Ø125 PN16 | 18.66€ |



Double Socket

| CODE | DESCRIPTION | PRICE |
|-----------|-------------------------|--------|
| 107.08.11 | Double Socket Ø25 PN16 | 0.72€ |
| 107.08.12 | Double Socket Ø32 PN16 | 0.98€ |
| 107.08.13 | Double Socket Ø40 PN16 | 1.51€ |
| 107.08.14 | Double Socket Ø50 PN16 | 1.94€ |
| 107.08.15 | Double Socket Ø63 PN16 | 3.85€ |
| 107.08.16 | Double Socket Ø75 PN16 | 5.10€ |
| 107.08.17 | Double Socket Ø90 PN16 | 5.63€ |
| 107.08.18 | Double Socket Ø110 PN16 | 9.15€ |
| 107.08.19 | Double Socket Ø125 PN16 | 16.53€ |
| 107.08.20 | Double Socket Ø140 PN16 | 22.85€ |
| 107.08.21 | Double Socket Ø160 PN16 | 26.05€ |

Male Adaptor



| CODE | DESCRIPTION | PRICE |
|-----------|---------------------------|-------|
| 107.07.00 | Male Adaptor 20x25x1/2" | 1.03€ |
| 107.07.02 | Male Adaptor 25x32x3/4" | 1.16€ |
| 107.07.03 | Male Adaptor 32x40x1" | 1.10€ |
| 107.07.05 | Male Adaptor 40x50x1 1/4" | 2.32€ |
| 107.07.06 | Male Adaptor 50x63x1 1/2" | 2.64€ |
| 107.07.11 | Male Adaptor 63x75x2" | 4.38€ |
| 107.07.12 | Male Adaptor 75x90x2 1/2" | 5.80€ |
| 107.07.17 | Male Adaptor 90x110x3" | 7.72€ |

Reducer



| CODE | DESCRIPTION | PRICE |
|-----------|------------------------|--------|
| 107.14.10 | Reducer Ø25-Ø20 PN16 | 0.69€ |
| 107.14.11 | Reducer Ø32-Ø25 PN16 | 0.86€ |
| 107.14.12 | Reducer Ø40-Ø32 PN16 | 0.98€ |
| 107.14.13 | Reducer Ø50-Ø32 PN16 | 1.18€ |
| 107.14.14 | Reducer Ø50-Ø40 PN16 | 1.59€ |
| 107.14.15 | Reducer Ø63-Ø32 PN16 | 1.73€ |
| 107.14.16 | Reducer Ø63-Ø50 PN16 | 2.39€ |
| 107.14.17 | Reducer Ø75-Ø63 PN16 | 2.61€ |
| 107.14.19 | Reducer Ø90-Ø75 PN16 | 3.43€ |
| 107.14.20 | Reducer Ø110-Ø90 PN16 | 4.56€ |
| 107.14.21 | Reducer Ø125-Ø110 PN16 | 7.05€ |
| 107.14.23 | Reducer Ø140-Ø125 PN16 | 14.44€ |
| 107.14.24 | Reducer Ø160-Ø140 PN16 | 22.85€ |

Tee



| CODE | DESCRIPTION | PRICE |
|-----------|---------------|--------|
| 107.16.02 | Tee Ø25 PN16 | 1.04€ |
| 107.16.03 | Tee Ø32 PN16 | 1.54€ |
| 107.16.04 | Tee Ø40 PN16 | 1.56€ |
| 107.16.05 | Tee Ø50 PN16 | 2.32€ |
| 107.16.06 | Tee Ø63 PN16 | 2.64€ |
| 107.16.07 | Tee Ø75 PN16 | 4.61€ |
| 107.16.08 | Tee Ø90 PN16 | 7.23€ |
| 107.16.09 | Tee Ø110 PN16 | 11.38€ |
| 107.16.10 | Tee Ø125 PN16 | 23.33€ |
| 107.16.11 | Tee Ø140 PN16 | 42.05€ |
| 107.16.12 | Tee Ø160 PN16 | 60.98€ |

Cross



| CODE | DESCRIPTION | PRICE |
|-----------|-----------------|---------|
| 107.13.00 | Cross Ø25 PN16 | 7.67€ |
| 107.13.01 | Cross Ø50 PN16 | 11.61€ |
| 107.13.02 | Cross Ø63 PN16 | 14.77€ |
| 107.13.03 | Cross Ø75 PN16 | 17.44€ |
| 107.13.04 | Cross Ø90 PN16 | 31.66€ |
| 107.13.05 | Cross Ø110 PN16 | 116.09€ |
| 107.13.06 | Cross Ø125 PN16 | 165.34€ |
| 107.13.07 | Cross Ø140 PN16 | 249.75€ |
| 107.13.08 | Cross Ø160 PN16 | 322.56€ |



Checkvalve

| CODE | DESCRIPTION | PRICE |
|-----------|----------------------|---------|
| 107.01.10 | Checkvalve Ø50 PN16 | 24.61€ |
| 107.01.11 | Checkvalve Ø63 PN16 | 31.66€ |
| 107.01.12 | Checkvalve Ø75 PN16 | 114.31€ |
| 107.01.13 | Checkvalve Ø90 PN16 | 149.15€ |
| 107.01.14 | Checkvalve Ø110 PN16 | 228.31€ |



True Union Ball Valve

| CODE | DESCRIPTION | PRICE |
|-----------|----------------------|---------|
| 107.02.20 | Ball Valve Ø32 PN16 | 20.39€ |
| 107.02.21 | Ball Valve Ø40 PN16 | 20.39€ |
| 107.02.22 | Ball Valve Ø50 PN16 | 22.51€ |
| 107.02.24 | Ball Valve Ø63 PN16 | 29.00€ |
| 107.02.27 | Ball Valve Ø75 PN16 | 60.50€ |
| 107.02.29 | Ball Valve Ø90 PN16 | 65.43€ |
| 107.02.30 | Ball Valve Ø110 PN16 | 239.21€ |



Threaded Ball Valve

| CODE | DESCRIPTION | PRICE |
|-----------|-------------------------|--------|
| 107.02.10 | Ball Valve Threaded Ø25 | 16.19€ |
| 107.02.11 | Ball Valve Threaded Ø32 | 23.58€ |
| 107.02.12 | Ball Valve Threaded Ø40 | 24.98€ |



Male Threaded Fitting

| CODE | DESCRIPTION | PRICE |
|-----------|---|--------|
| 107.11.20 | Male Threaded Union Ø50 -> 1 1/2" PN16 | 10.21€ |
| 107.11.21 | Male Threaded Union Ø63 -> 1 1/2" PN16 | 13.03€ |
| 107.11.22 | Male Threaded Union Ø63 -> 2" PN16 | 13.03€ |



True Union Fitting

| CODE | DESCRIPTION | PRICE |
|-----------|-----------------|--------|
| 107.11.01 | Union Ø25 PN16 | 4.75€ |
| 107.11.02 | Union Ø32 PN16 | 6.51€ |
| 107.11.03 | Union Ø40 PN16 | 8.09€ |
| 107.11.04 | Union Ø50 PN16 | 8.45€ |
| 107.11.05 | Union Ø63 PN16 | 11.39€ |
| 107.11.06 | Union Ø75 PN16 | 19.90€ |
| 107.11.07 | Union Ø90 PN16 | 26.39€ |
| 107.11.08 | Union Ø110 PN16 | 50.66€ |



Barell Nipple

| CODE | DESCRIPTION | PRICE |
|-----------|--------------------------|-------|
| 107.09.03 | Nipple 1/2" (Ø20) PN16 | 1.25€ |
| 107.09.06 | Nipple 3/4" (Ø25) PN16 | 1.61€ |
| 107.09.02 | Nipple 1" (Ø32) PN16 | 1.83€ |
| 107.09.01 | Nipple 1 1/4" (Ø40) PN16 | 2.37€ |
| 107.09.00 | Nipple 1 1/2" (Ø50) PN16 | 2.37€ |
| 107.09.05 | Nipple 2" (Ø63) PN16 | 2.95€ |



Butterfly Valve

| CODE | DESCRIPTION | PRICE |
|-----------|---------------------------|---------|
| 107.02.00 | Butterfly Valve Ø63 PN16 | 143.52€ |
| 107.02.01 | Butterfly Valve Ø75 PN16 | 152.67€ |
| 107.02.02 | Butterfly Valve Ø90 PN16 | 172.36€ |
| 107.02.03 | Butterfly Valve Ø110 PN16 | 189.96€ |
| 107.02.04 | Butterfly Valve Ø125 PN16 | 204.02€ |
| 107.02.05 | Butterfly Valve Ø140 PN16 | 233.92€ |
| 107.02.06 | Butterfly Valve Ø160 PN16 | 307.80€ |



Check Valve with Flange

| CODE | DESCRIPTION | PRICE |
|-----------|-------------------------------|---------|
| 107.01.00 | Check Valve Flanged Ø63 PN16 | 107.99€ |
| 107.01.01 | Check Valve Flanged Ø75 PN16 | 122.96€ |
| 107.01.02 | Check Valve Flanged Ø90 PN16 | 144.22€ |
| 107.01.03 | Check Valve Flanged Ø110 PN16 | 162.52€ |
| 107.01.04 | Check Valve Flanged Ø125 PN16 | 180.47€ |
| 107.01.05 | Check Valve Flanged Ø140 PN16 | 271.58€ |
| 107.01.06 | Check Valve Flanged Ø160 PN16 | 289.50€ |



Female Threaded Adaptor

| CODE | DESCRIPTION | PRICE |
|-----------|--|-------|
| 107.06.00 | Female Threaded Adaptor 20x25x1/2" PN16 | 2.64€ |
| 107.06.01 | Female Threaded Adaptor 25x32x3/4" PN16 | 3.16€ |
| 107.06.02 | Female Threaded Adaptor 32x40x1" PN16 | 3.80€ |
| 107.06.03 | Female Threaded Adaptor 40x50x1 1/4" PN16 | 3.85€ |
| 107.06.04 | Female Threaded Adaptor 50x63x1 1/2" PN16 | 3.95€ |
| 107.06.05 | Female Threaded Adaptor 63x75x2" PN16 | 4.07€ |
| 107.06.06 | Female Threaded Adaptor 75x2 1/2" PN16 | 8.09€ |
| 107.06.07 | Female Threaded Adaptor 90x3" PN16 | 8.79€ |



PP Clamp Saddle (4 bolts)

| CODE | DESCRIPTION | PRICE |
|-----------|---------------------------------|---------|
| 107.12.00 | PP Clamp Saddle 10atm Ø25x1/2" | 2.07€ |
| 107.12.01 | PP Clamp Saddle 10atm Ø50x1/2" | 3.26€ |
| 107.12.02 | PP Clamp Saddle 10atm Ø63x1/2" | 3.98€ |
| 107.12.03 | PP Clamp Saddle 10atm Ø75x3/4" | 4.53€ |
| 107.12.04 | PP Clamp Saddle 10atm Ø75x1/2" | 6.75€ |
| 107.12.05 | PP Clamp Saddle 10atm Ø90x1/2" | 8.96€ |
| 107.12.06 | PP Clamp Saddle 10atm Ø110x1/2" | 10,21 € |



Metal Clamp with screw and Flange

| CODE | DESCRIPTION | PRICE |
|-----------|--|-------|
| 300.02.03 | Metal Clamp with Screw and Flange Ø50 | 2.07€ |
| 300.02.04 | Metal Clamp with Screw and Flange Ø63 | 3.26€ |
| 300.02.05 | Metal Clamp with Screw and Flange Ø75 | 3.98€ |
| 300.02.06 | Metal Clamp with Screw and Flange Ø90 | 4.53€ |
| 300.02.07 | Metal Clamp with Screw and Flange Ø110 | 6.75€ |
| 300.02.08 | Metal Clamp with Screw and Flange Ø125 | 8.96€ |

U-PVC Pn10 Pipe



| CODE | DESCRIPTION | PRICE |
|-----------|--------------------|--------|
| 107.15.09 | PVC Pipe Ø25 PN10 | 5.31€ |
| 107.15.00 | PVC Pipe Ø32 PN10 | 5.47€ |
| 107.15.01 | PVC Pipe Ø50 PN10 | 6.02€ |
| 107.15.02 | PVC Pipe Ø63 PN10 | 8.88€ |
| 107.15.03 | PVC Pipe Ø75 PN10 | 12.12€ |
| 107.15.04 | PVC Pipe Ø90 PN10 | 17.29€ |
| 107.15.05 | PVC Pipe Ø110 PN10 | 19.97€ |
| 107.15.06 | PVC Pipe Ø125 PN10 | 24.42€ |
| 107.15.07 | PVC Pipe Ø140 PN10 | 33.40€ |
| 107.15.08 | PVC Pipe Ø160 PN10 | 47.34€ |

PVC Flexible Pn10 Pipe



| CODE | DESCRIPTION | PRICE |
|-----------|----------------------------|--------|
| 107.15.20 | PVC Flexible Pipe Ø32 PN10 | 8.80€ |
| 107.15.21 | PVC Flexible Pipe Ø40 PN10 | 10.65€ |
| 107.15.22 | PVC Flexible Pipe Ø50 PN10 | 10.97€ |
| 107.15.23 | PVC Flexible Pipe Ø63 PN10 | 16.47€ |

Flow Meter



| CODE | DESCRIPTION | PRICE |
|-----------|-------------------------------------|---------|
| 305.05.19 | Flow meter 02 -16 m ³ /h | 262.50€ |

Inspection Glass



| CODE | DESCRIPTION | PRICE |
|-----------|--------------------------------------|--------|
| 107.02.19 | Inspection Glass True Union ø63 PN10 | 62.50€ |



PVC Cement

| CODE | DESCRIPTION | PRICE / pack |
|-----------|--------------------|--------------|
| 107.05.05 | PVC Cement 0,5 lit | 29.90€ |
| 107.05.01 | PVC Cement 1 lit | 49.90€ |



PVC Cement Bluetite

| CODE | DESCRIPTION | PRICE / pack |
|-----------|-----------------------------|--------------|
| 107.05.03 | PVC Cement Bluetite 0,5 lit | 34.90€ |
| 107.05.04 | PVC Cement Bluetite 1 lit | 54.90€ |



Safety Check Valve

The safety check valve is specially designed for swimming pool and spa. It ensures the directional flow of water from swimming pool and spa, and prevents water from back flow. In order to avoid generating water hammer, we apply a transparent cover, that is convenient to watch flow direction of water.



| CODE | DESCRIPTION | PRICE |
|-----------|------------------------|--------|
| 107.01.16 | Ø63 Safety check valve | 70.01€ |

Cathodic Protection System

Ultimate Corrosion Defense for Your Pool Equipment

Protect your investment with our Cathodic Protection System, the perfect solution for preventing corrosion in swimming pools—especially those using salt chlorinators. This advanced system extends the lifespan of metal components, such as ladders, heat exchangers, and lighting fixtures, by preventing electrochemical deterioration.

- Ideal for saltwater pools
- Prevents corrosion & extends equipment life
- Easy installation & maintenance-free operation

Ensure long-lasting durability and optimal performance for your pool with Oxygen's Cathodic Protection System!



| CODE | DESCRIPTION | PRICE |
|-----------|----------------------------|--------|
| 107.01.21 | Cathodic Protection System | 89.00€ |



Oxygen Greece

Email: info@oxygen.gr **Phone:** +30 231 081 00 00 **Web:** www.oxygen.gr **Address:** Karamaouna str, N. Rysio, Thermi, 57001, Greece

Oxygen Romania

Email: info@oxygen.ro **Phone:** +40 753 380 848 **Web:** www.oxygen.ro **Address:** Strada Constelatiei 1 Bis, Voluntari, 077191, Romania